

AMORTISSEURS

# SIAAM



# 2019

Passenger Cars and Light  
Commercial Vehicles

# CATALOGUE

AMORTISSEURS | SHOCK ABSORBERS | AMORTIGUADRES | STOßDÄMPFER



## LA SIA EN BREF

La société Industrielle d'Amortisseurs a été fondée en 1989 en partenariat avec RECORD France. SIA est leader dans la fabrication et la commercialisation des amortisseurs au sud de la méditerranée. Elle fournit les principaux constructeurs automobiles européennes en pièces d'origine et de rechange, et assure la sous-traitance pour le compte des plus grands fabricants d'amortisseurs mondiaux.

Sa propre marque " SIA'AM " s'est imposée aussi bien à l'étendue locale en Tunisie que dans les marchés européens africains et arabes.

## ABOUT SIA

SIA (Société Industrielle d'Amortisseurs) a privately owned company in Tunisia, was founded in the early 1989's in partnership with RECORD France.

Over the last, SIA has become the most advanced and largest manufacturer of shock absorbers of the south Mediterranean. SIA has a customer base that includes major international automakers as an OE manufacturer and supplier.

The brand "SIA'AM", its homemade trademark, is among the most relevant brands in the Tunisia local market and is also capturing the European, African and Asian zones as well.

## FONCTION DES AMORTISSEURS

L'amortisseur est un dispositif destiné à limiter voir supprimer les chocs et les vibrations du véhicule. Il a pour mission de maintenir la liaison entre la roue et le châssis et de préserver ainsi la sécurité et le confort des passagers

## FUNCTION OF THE SHOCK ABSORBERS

The shock absorber is a device that reduces the shocks and vibration of the vehicle. Its mission is to maintain the connection between the wheel and the chassis and thereby preserve the safety and comfort of passengers.

## POURQUOI CHOISIR LES MARQUES SIA'AM & RECORD ?

- LA SIA est le leader dans la fabrication et la commercialisation des amortisseurs en Tunisie et en Afrique du nord.
- LA SIA est fournisseur des constructeurs automobile 1ère monte et pièces d'origine.
- LA SIA fournit les plus grands fabricants d'amortisseurs dans le monde.
- SIA dispose d'une large gamme avec plus de 3000 références et couvre plus que 90% du parc présent en méditerranéen.
- La SIA est capable de satisfaire les besoins de ses clients avec tous types d'amortisseurs bitubes aussi bien en hydraulique qu'en gaz.
- Des années d'expertise dans nos laboratoires ont permis l'optimisation de notre processus de fabrication conformément aux standards européens, afin de vous garantir un confort et une sécurisé irréprouchables.
- Le produit SIA est conforme aux standards européens réglementaires, sécuritaires environnementaux et légaux.
- Le système qualité SIA est certifié IATF 16949 (version 2016), ISO 14001 (version 2015) et ISO 45001 (version 2018).

## WHY CHOOSING RECORD/SIA'AM BRAND?

- SIA is the leader in manufacturing and commercialization of shock absorbers in Tunisia and North Africa.
- SIA is OEM and OES supplier
- SIA supplies the biggest shock absorber manufacturers in the world.
- SIA has a wide range with over 3000 references and covers over than 90% of parc the Mediterranean.
- SIA is able to satisfy the needs of its customers with twin-tube shock absorbers both in hydraulic and gas technologies.
- Years of expertise in our laboratories allowed the optimization of our manufacturing process according to the European standards in order to guarantee your comfort and safety.
- SIA product complies with regulatory, environmental and legal European standards.
- The SIA quality system is IATF 16949 (version 2016), ISO 14001 (version 2015) and ISO 45001 (version 2018) certified.



### Pourquoi remplacer les amortisseurs ?

- Des amortisseurs usés ou défectueux n'assurent plus une tenue de route optimale du véhicule.

### Quand remplacer les amortisseurs ?

Pour une utilisation optimale des amortisseurs et un diagnostic précis de leur état, il est conseillé de procéder au contrôle technique régulier tous les 20 000 km.

Le remplacement est recommandé au seuil des 80 000 km (ou tous les 4 ans), avant cette distance si l'environnement de la conduite est du type rude tel qu'en Afrique du nord, ou si vous constatez l'un des phénomènes suivant :

- Dépôt par l'effet d'un brusque changement de direction
- Distance de freinage rallongée
- Vibrations au volant
- Usure irrégulière des pneumatiques
- Balance importante en virage

### Why replacing the shock absorbers?

- Worn or defective shock absorbers provide reduce the contact of wheels with the ground

### When replacing the shock absorbers?

For an optimal use of shock absorbers and a precise diagnosis of their condition, it is recommended to carry out a regular inspection every 20 000 km.

The replacement is recommended at the threshold of 80,000 km (or every 4 years) before that distance if the driving environment is rough such as in North Africa, or as soon as you notice one of these anomalies:

- Unsteadiness due to a sudden change of direction
- Extended braking distance
- Vibration in the steering wheel
- Irregular wear in the wheels
- Significant swing in bends

### Les Technologies SIA'AM / RECORD pour les amortisseurs / The Shock Absorbers Technologies

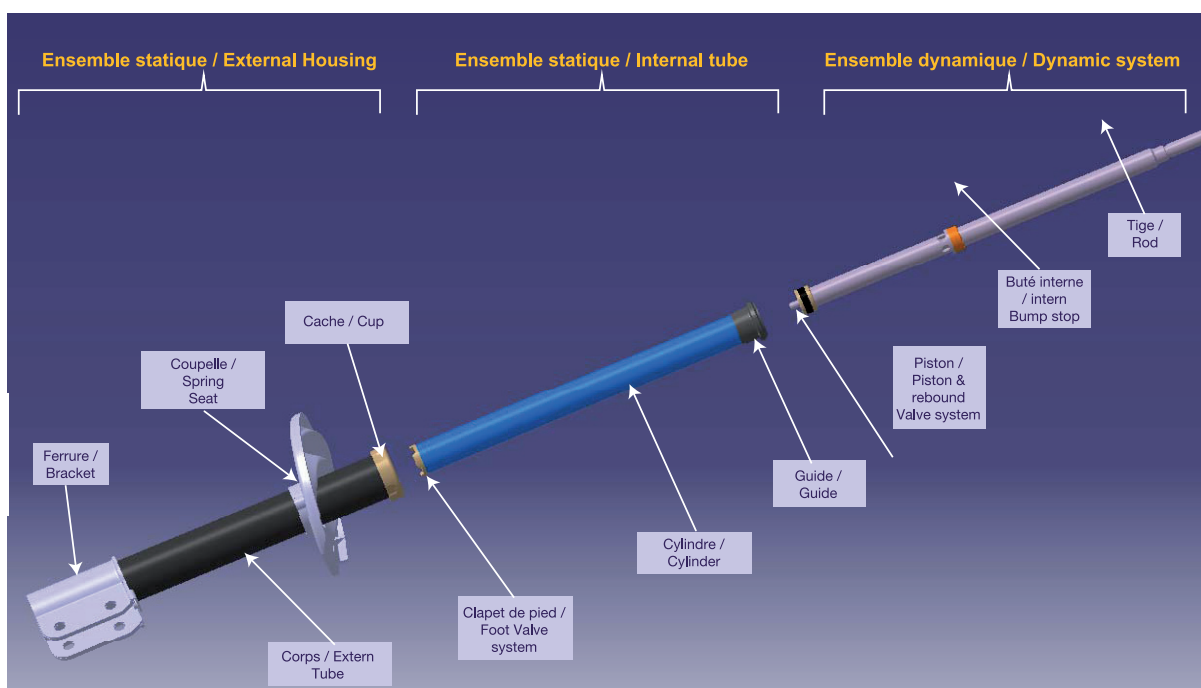

### L'Amortisseur Hydraulique

- Amortisseur bi-tube avec réservoir de compensation et système hydraulique.

C'est la technologie d'amortisseur la plus répandue. Il s'agit de faire passer l'huile d'une chambre à l'autre par des diaphragmes qui créent une résistance hydraulique.

L'Amortisseur hydraulique propose une limitation des oscillations dues à l'état de la route, un freinage des mouvements du véhicule et une suppression des rebonds de la roue.

### L'Amortisseur à Gaz

- Amortisseur bi-tube avec système hydraulique pressurisé basse pression.

Il est basé sur le principe de l'amortisseur hydraulique. Il contient du gaz à basse pression au niveau de la chambre extérieure.

L'Amortisseur gaz améliore la performance lors du démarrage, atténue le bruit de véhicule et optimise la suspension de la voiture.

### The Hydraulic Shock Absorber

- Twin-tube Shock Absorber with catchup tank and hydraulic system.

This is the most widespread technology for shock absorbers.

It is about oil transfer from the rebound area to the compression area through the valves which create a hydraulic resistance.

The hydraulic shock absorber limitates the oscillations due to road conditions, brakes vehicle movement and eliminates the wheel bounces

### The Gas Shock Absorber

- Twin-tube sock absorber with pressurized hydraulic system .

It is based on the principle of the hydraulic shock absorber. It contains low pressure gas at the rebound room.

The gas shock absorber improves the performance when starting, softens the vehicle noise and optimizes wheels suspension.

## Recommandations de montage

### • Sécurité :

Les amortisseurs doivent toujours être remplacés par paire (avant ou arrière) pour garantir l'équilibre du véhicule, sa tenue de route, ainsi que l'efficacité de son freinage

### • Contrôles avant montage :

#### Vérifier :

- Le bon état du train avant et de la direction.
- L'absence de jeu dans les rotules et les barres d'accouplement.
- Le bon état des protecteurs, roulement, butées et autres organes de suspension extérieurs à l'amortisseur.
- Le degré d'affaissement des ressorts.
- Le gonflage des pneus et l'équilibre des roues.
- Le bon choix des références d'amortisseurs sélectionnées.

## Montage

Le sens du montage est indiqué par une flèche sur le corps de l'amortisseur

Faire fonctionner l'amortisseur à la main dans sa position normale de montage pour assurer son amorçage.

Utiliser l'outillage approprié lors du montage de l'appareil sur le véhicule.

#### NB :

- La tige de l'amortisseur ne doit en aucun cas être saisie avec une pince ou marquée par un outil
- Toute détérioration de son état de surface entraînerait la mise hors service du joint d'étanchéité et donc de l'amortisseur
- Remplacer tout kit de butée de suspension en mauvaise état : roulement bloqué ou palier usé peuvent provoquer la rupture de la fixation supérieure de l'amortisseur
- Remplacer tout kit de protection usé pour éviter la corrosion du chrome de la tige de piston et donc éviter toute fuite d'oléofluide
- Assembler tous les composants et accessoire de montage dans le bon ordre et la bonne position, et respecter les couples de serrage des boulons et écrous de fixation indiqués par le constructeur du véhicule, pour éviter tous risques de bruit de claquement ou de rupture de fixations. L'utilisation d'une clef à chocs est déconseillée.
- Ne pas bloquer les fixations d'amortisseur en position roues pendantes. Les bloquer impérativement roues au sol, le système de suspension se trouvant en position normale de fonctionnement.

### • Contrôles après montage

Après réglage de Jambes de Force Mac-Pherson à l'avant, vérifier le réglage du train avant

**NB :** Les amortisseurs usagés qui sont démontés contiennent de l'huile et peut-être du gaz. Ils doivent être éliminés selon les procédures spécifiées par la réglementation en matière de protection de l'environnement.

## Garantie

Ne pas tenir compte des recommandations ci-dessus peut invalider toute garantie

- Le produit SIA est garanti 1 an à partir de la date d'achat
- La garantie ne peut jouer si l'amortisseur a fait l'objet d'un usage anormal

## Fitting instructions

### • Safety :

*Shock absorber must always be replaced in pairs (front or rear) to maintain and ensure the vehicle balance, handling and braking efficiency.*

### • Before fitting :

#### check :

- *The good condition of the front axle and the steering*
- *That there is no play in the ball-joints and coupling rods*
- *The good condition of the shields, ball-bearings, bump stops and other associated suspension elements environing the shock absorber.*
- *That the springs have not given in.*
- *Tyre pressure and wheel balance.*
- *That the selected shock absorber part numbers are the right ones.*

### • Installation

*Hold the shock absorber in its normal position and make the oil circulate to prime the damper.*

*Use appropriate tooling during the fitting of the shocks on the vehicle.*

#### NB :

- *It is strictly forbidden to hold the piston rod with pliers or mole grips avoid any contact with tools*
- A dented rod puts the seals out of order, causes an oil leakage and therefore damage to the shock absorber*
- *Replace any top bearing kits in bad condition: a blocked bearing or a worn-out top plate set may lead to a snapping-off of the upper attachment.*
- *Replace any worn-out protection kits : this will prevent the piston rod chrome from being corroded, and therefore the damper from leaking.*
- *Please install all the mounting components & parts in the correct order and in the correct position, and please observe that the torque setting for the fixing bolts and nuts are tightened in accordance to the vehicle manufacturer's specifications, to avoid any risks of knocking noise and any risks of breaking-off of the attachment. The use of an air gun is not advisable*
- *Do not lock the attachments fully while the wheels are hanging. The final locking must be carried out with the wheels on the ground, in the normal functioning position of the suspension.*

### • After fitting

*When front Mac-Pherson struts are replaced, wheel-camber angle and steering alignment should always be checked.*

**NB :** *The worn shock absorbers which are removed contain oil and perhaps gas. They must be disposed of, according to the procedures by the environment protection regulations.*

### • Warranty :

*Not taking the above instructions into account may invalidate the warranty.*

- *The SIA product is guaranteed for one year from the date of purchase*
- *The warranty is not effective if the shock absorber has been submitted to an abnormal use or to operating conditions other than those specified by the manufacturer*

<b>COMMENT LIRE UNE RÉFÉRENCE SIAAM / HOW TO READ A SIAAM REFERENCE</b>	<b>5</b>
<b>LES DIFFÉRENT TYPES D'AMORTISSEURS / THE VARIOUS TYPES OF SHOCK ABSORBERS</b>	<b>6</b>
<b>STRUCTURE PAGE D'APPLICATION / APPLICATION PAGES STRUCTURE</b>	<b>7</b>
<b>DÉSIGNATION ICÔNES / DESIGNATION ICONS</b>	<b>8</b>
<b>NOUVEAUTÉS / NEW ADDITIONS</b>	<b>10</b>
<b>RÉFÉRENCES ALTERNATIVES / ALTERNATIVE REFERENCES</b>	<b>14</b>
<b>TABLEAU DES APPLICATIONS / TABLE OF APPLICATIONS</b>	<b>16</b>
ALFA ROMEO	17
ALPINE RENAULT	19
ARO	19
AUDI	19
AUSTIN	34
AUTOBIANCHI	35
BEDFORD	35
BMW	36
CHEVROLET EUROPE	48
CHRYSLER	49
CITROËN	50
COURNIL	60
DACIA	60
DAEWOO	62
DAF	63
DAIHATSU	64
DAIMLER	65
DKW	65
EBRO	65
FACEL VEGA	65
FIAT	66
FORD	80
FREIGHT ROVER	98
HANOMAG HENSCHER	98
HILLMAN	98
HINO	99
HONDA	99
HUMBER	100
HYUNDAI	100
INNOCENTI	101
ISUZU	102
IVECO	104
JAGUAR	104
JEEP	105
JENSEN	105
KIA	106
LADA	106
LANCIA	107
LAND ROVER	111
MAHINDRA	112
MATRA	112
MAZDA	113
MERCEDES	118
MINI	118
MITSUBISHI	132
MORRIS	138
MOSKVITCH	138
NISSAN	138
NSU	149
OPEL	149
PANHARD	162
PEUGEOT	162
POLONEZ	183
POLSKI (FIAT - POLMO)	184
PORSCHE	184
RELIANT	185
RENAULT	185
ROVER	223
SAAB	224
SEAT	225
SIMCA France	233
SINGER	234
SKODA	235
SSANGYONG	240
STEYR PUCH	240
SUBARU	240
SUNBEAM	241
SUZUKI	241
TALBOT France	243
TALBOT U.K.	244
TATA	245
TOYOTA	245
TRABANT	259
TRIUMPH	259
UMM	260
VAUXHALL	260
VOLGA	265
VOLKSWAGEN	265
VOLVO	283
WARTBURG	284
WILLYS	285
WOLSELEY	286
ZASTAVA	286
Observations / Comments	287
<b>TABLE DES CORRESPONDANCES OEM / OEM CORRESPONDENCE</b>	<b>298</b>
<b>Liste Numérique / Numerical Listing</b>	<b>330</b>

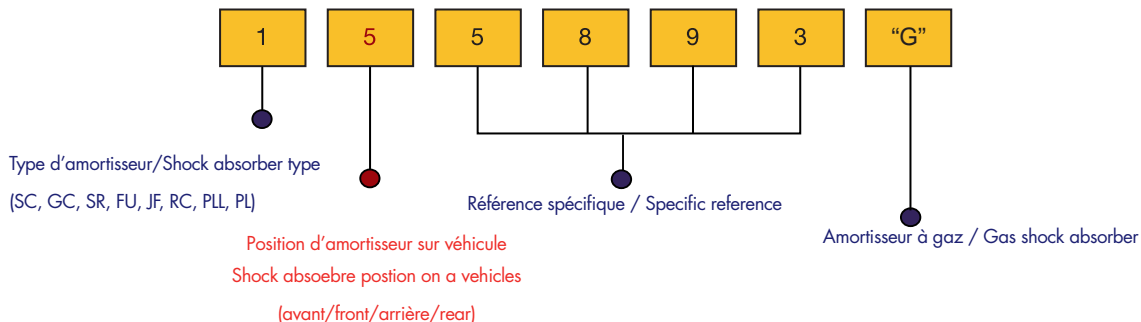

## LES FIXATIONS HAUT / BAS ET COMMENT LIRE LE SECOND CHIFFRE :

- Avant : Si l'amortisseur est positionné en avant il prendra un nombre pair ou zéro.
- Arrière : Si l'amortisseur est positionné en arrière il prendra un nombre impair.

## UP / DOWN BINDINGS AND HOW TO READ THE SECOND NUMBER:

- Front: If the shock absorber is positioned at the front it takes an even number or zero.
- Rear: If the shock absorber is positioned backwards it takes an odd number.

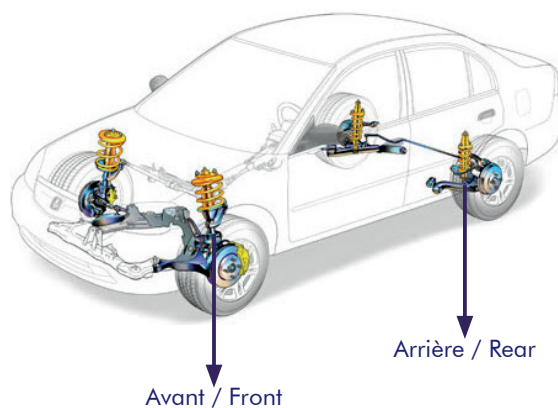

Œil / Œil



Avant Amortisseur / Front Shock absorber = 0  
Arrière Amortisseur / Rear Shock absorber = 1

Œil / Tige



Avant Amortisseur / Front Shock absorber = 2  
Arrière Amortisseur / Rear Shock absorber = 3

Œil / Tige



Avant Amortisseur / Front Shock absorber = 4  
Arrière Amortisseur / Rear Shock absorber = 5

Tige / Tige



Avant Amortisseur / Front Shock absorber = 6  
Arrière Amortisseur / Rear Shock absorber = 7



**SC : SUPER CONFORT**

**SÉRIES 10 0000**

Amortisseur télescopique avec des tarages étudiés dans un esprit seconde monte.  
*Telescopic shock absorber with damping forces engineered for replacement requirements.*



**GC : GRANDE CAPACITÉ**

**SÉRIES 20 0000**

Amortisseur de type " SC " avec capacité de fonctionnement renforcée.  
*" SC " type shock absorber with strengthened functioning capacity. (Heavy duty)*



**SR : SUPPORT DE RESSORT**

**SÉRIES 30 0000**

Amortisseur de type " SC " OU " GC " à fixations renforcées, livré avec coupelle support de ressort soudée ou amovible.  
*" SC " OR " GC " types shock absorber with reinforced attachments, supplied with welded or removable spring seat.*



**FU : FUSÉE**

**SÉRIES 40 0000**

Amortisseur cartouche pour suspension de type Mac-Pherson.  
*Insertable shock absorber cartridge for original Mac-Pherson type suspension.*



**JF : JAMBE DE FORCE**

**SÉRIES 50 0000**

Jambe de force complète pour suspension de type Mac-Pherson.  
*Complete sealed strut for original Mac-Pherson suspension.*



**RC : RESSORT COMPENSATEUR**

**SÉRIES 60 0000**

Amortisseur avec ressort compensateur de charge destiné aux véhicules qui fréquemment, transportent de lourdes charge, ou tractent des remorques ou caravanes.  
*Shock absorber with load compensator spring, designed for vehicles which, frequently, are heavily laden, or tow trailers or caravans.*



**PLL : POIDS LOURD LÉGER**

**SÉRIES 70 0000**





Amortisseur Télescopique avec tige et piston surdimensionnées pour une capacité de fonctionnement renforcée.  
*Telescopic shock absorber with overdimensioned shaft and piston for reinforced functioning capacity.*



**PL : POIDS LOURD**

**SÉRIES 80 0000**

Amortisseur Télescopique avec tige, piston et corps surdimensionnés pour une capacité de fonctionnement renforcée.  
*Telescopic shock absorber with overdimensioned shaft, piston and body for reinforced functioning capacity.*

MODELE MODEL	ANNEE / YEAR						
		AVANT / FRONT			ARRIÈRE / REAR		
		GAZ / GAS	HYD	TYPE	GAZ / GAS	HYD	TYPE
<b>CITROËN BERLINGO I FIRST (4x2): 04.08 &gt; EXCEPT BERLINGO II</b>							
<b>Berlingo 1 FIRST</b>							
  	(2)	545280G L	545280 L	JF	215292G	215292	GC
	04.08 »	545291G R	545291 R	JF	215292G	215292	GC

Type de véhicule  
Vehicle types

APPLICATION :

- Berline / Saloon = Sedan
- Break / Estate = Station wagon
- Cabriolet = Convertible

Date de fabrication véhicule  
Vehicle manufacturing date



Références spécifique technologie Gaz  
Gaz specific part number

Références spécifique technologie hydraulique  
Hydraulic technology Specific part number

Type d'amortisseur  
Type of shock absorber (SC, GC, SR, FU, JF, RC, PLL, PL)

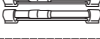

				
1	 Tous	All Models	Tutti	Alle
2	 Berline / Saloon 2 / 4 Portes	2 / 4 Doors Saloon	Berlina 2 / 4 Porte	Limousine 2 / 4 Türen
3	 Berline / Saloon 3/5 Portes	3 / 5 Doors Saloon	Berlina 3 / 5 Porte	Hatchback 3 / 5 Türen
4	 Coupé	Coupé / Liftback / 3 Doors	Coupé / Liftback	Coupé
5	 Cabriolet	Convertible	Cabrio / Convertibile	Cabriolet
6	 Break / Estate	Break / Estate	Famigliare	Kombi
7	 4x4 / 4 Roues motrices	4x4 / 4 Wheels drive / Off road	4x4 / fuoristrada / Quatro Ruote Motrici	4x4 / Allradantrieb
8	 4x2 / 2 Roues motrices	4x2 / 2 Wheels drive	4X2 / 2 Ruote motrici	4X2 / 2 Radantrieb
9	 Sport	Sport drive	Sport	Sport
10	 Pick-up	Pick-up	Pick-up	Pick-up
11	 Fourgonnette vitrée	MPV	Giardinetta	Hochdachkombi / MPV
12	 Fourgonnette tolée	VAN	Giardinetta / VAN	Kastenwagen / Van
13	 Fourgon	Delivery van	Furgone	Lieferwagen
14	 Mini Bus	Mini Bus	Minibus	Minibus
15	 Chassis cabine	Chassis cabine	Cabinato	Fahrgestell mit fahrerhaus
16	 Charge utile	Load capacity	Portata massima	Nutzlast
17	 Boite automatique	Automatic transmission	Cambio automatico	Automatikgetriebe
18	 Boite manuelle	Manual transmission	Cambio tanuale	Schaltgetriebe
19	 Numéro de chassis	Chassis number	Telaio N°	Fahrgestell N°
20	 Suspension renforcée	Heavy Duty	Sospensione Rinforzata	Verstärkte federung
21	 Longueur Fermée x Longueur ouverte	Closed length x Extended length	Lunghezza aperto x Lunghezza chiuso	Lange gedrückt x Lange gezogen
22	 Suspension sport	Sport suspension	Sospensione sportiva	Sportfederung
23	 Suspension réhaussée	Raised suspension	Sospensione rialzata	Hohe auffhängung

					
24		Suspension surbaissée	Lowered suspension	Sospensione ribassata	Tiefe aufhängung
25		Suspension mauvaise route	Rough roads	Sospensioni strade sconnesse	Schlechte stra enverhältnisse
26		Suspension arrière	Rear suspension	Sospensione posteriore	Hinterachse
27		Suspension pneumatique	Pneumatic suspension	Sospensione ad aria	Luftfederung
28		Suspension multi-bras	Multi-Link suspension	Sospensione multi-link	Multi-link achse
29		Empattement	Wheel base distance	Interasse	Radstand
30	<b>M-Tech</b>	Technique M	M Technic	M Technic	M-Technik
31		Essieu rigide	Rigid Axle	Asse rigido	Starre achse
32		Roue indépendante	Independent axle	Asse indipendente	Unabhängig achse
33		Barre stabilisatrice	Stabilizer bar	Barra stabilizzatrice	Stabilisatorstabes
34		2 barres de torsion	2 Torsion bars	2 Barre di torsione	2 Torsionsstäbe
35		4 barres de torsion	4 Torsion bars	4 Barre di torsione	4 Torsionsstäbe
36		Ressorts à lames	Leaf spring	Molla a balestra	Blattfederachse
37		Direction assistée	Power steering	Servosterzo	Servolenkung
38		Suspension avec ressorts hélicoïdaux	Coil spring	Molla elicoidale	Schraubenfederachse
39		Pneu Simple	Single Tyre	Ruote singole	Einfachbereifung
40		Pneus jumelés	Double Tyre	Ruote gemellari	Doppelbereifung
41		Roues	Wheels	Ruote	Räder
42		Diamètre	Diameter	Diametro	Durchmesser
43		Tige supérieure	Upper stem	Perno superiore	Stift oben
44		Tige inférieure	Lower stem	Perno inferiore	Stift unten
45		Œillet supérieur	Upper loop	Occhio superiore	Auge oben
46		Œillet inférieur	Lower loop	Occhio inferiore	Auge unten



---

# **NOUVEAUTÉS** **NEW ADDITIONS**

---

[www.sia-am.com](http://www.sia-am.com)

SIAAM	Modèle / Model	Position	Type de fixation / Mounting Type
115778(G)	MERCEDES Vaneo	AR	SC
145694(G)	MERCEDES CLASSE E - BERLINE / SALOON : AVANTGARDE	AV	SC
145742(G)	NISSAN TRADE - CHASSIS-CABINE - 3.0	AV	SC
155630(G)	BMW 3-E46	AR	SC
155648(G)	AUDI A4	AR	SC
155649(G)	AUDI A4	AR	SC
155781(G)	FIAT/SUSUKI SEDICI/SX4	AR	SC
155904(G)	TOYOTA YARIS 3 XP15 / VIOS	AR	SC
155907(G)	DACIA SANDERO STEPWAY 1	AR	SC
205461(G)	RENAULT MASTER	AV	GC
215020(G)	MITSUBISHI L200 4X4		GC
215651(G)	NISSAN CAB	AR	GC
215743(G)	NISSAN TRADE - CHASSIS-CABINE - 3.0	AR	GC
215803(G)	FIAT DOBLO II	AR	GC
215937(G)	TOYOTA HI-LUX KUN 15 - 16 4X2	AR	GC
215977(G)	TOYOTA RAV 4 III	AR	GC
255640(G)	NISSAN CAB	AR	GC
255659(G)	SSONGYONG MUSSO	AR	GC
255734(G)	AUDI A6	AR	GC
255793(G)	SKODA YETI	AR	GC
755960(G)	TOYOTA COROLLA E170 / AURIS E150	AR	PLL
255974(G)	NISSAN JUKE	AR	GC
274835(G)	BMW X1	AR	GC
355966(G)	TOYOTA COROLLA E120 GB / J 5 PORTES 2002 --> 2007	AR	SR
355969(G)	TOYOTA COROLLA TAXI E140 J 2008 -->	AR	SR
355971(G)	TOYOTA COROLLA VERSO (E12)	AR	SR
545011(G)	HYUNDAI: I10	AVD	JFD
545401(G)	BMW SERIE 3 E46	AVD	JFD
545490(G)	BMW SERIE 3 E46	AVG	JFG
545517(G)	FORD COUGAR	AV	JF
545617(G)	FORD TOURNEO / CONNECT	AV	JF
545681(G)	MAZDA III	AVG	JFG
545682(G)	MAZDA III	AVD	JFD
545755(G)	BMW SERIE 1 ET 3 MODÈLES E87 / E90	AVG	JFG
545756(G)	BMW SERIE 1 ET 3 MODÈLES E87 / E90	AVD	JFD
545832(G)	BMW Z4 - (E89)	AVG	JFG

SIAAM	Modèle / Model	Position	Type de fixation / Mounting Type
545833(G)	BMW Z4 - (E89)	AVD	JFD
545900(G)	HYUNDAI: I10	AVG	JFG
545902(G)	TOYOTA YARIS 3 XP15 / VIOS	AVD	JFD
545903(G)	TOYOTA YARIS 3 XP15 / VIOS	AVG	JFG
545914(G)	KIA PICANTO I	AVG	JFG
545915(G)	KIA PICANTO I	AVD	JFD
545922(G)	PEUGEOT 308 II	AV	JF
545926(G)	KIA PICANTO 2	AVG	JFG
545927(G)	KIA PICANTO 2	AVD	JFD
545938(G)	HYUNDAI / KIA: ACCENT 4 / RIO 3	AVG	JFG
545939(G)	HYUNDAI / KIA: ACCENT 4 / RIO 3	AVD	JFD
545940(G)	PEUGEOT 2008 Ø 51	AVG	JFG
545941(G)	HYUNDAI I20	AVG	JFG
545942(G)	HYUNDAI I20	AVD	JFD
545943(G)	RENAULT MASTER 3	AV	JF
545951(G)	PEUGEOT 2008 Ø 51	AVD	JFD
545953(G)	CITROEN C4 CACTUS	AVG	JFG
545954(G)	CITROEN C4 CACTUS	AVD	JFD
545956(G)	OPEL MOKKA	AVG	JFG
545957(G)	OPEL MOKKA	AVD	JFD
545959(G)	RENAULT TWINGO 3	AV	JF
545961(G)	OPEL ADAM	AVG	JFG
545962(G)	OPEL ADAM	AVD	JFD
545964(G)	TOYOTA COROLLA E120 GB / J 5 PORTES 2002 --> 2007	AVG	JFG
545965(G)	TOYOTA COROLLA E120 GB / J 5 PORTES 2002 --> 2007	AVD	JFD
545967(G)	TOYOTA COROLLA E140 J 2008 -->	AVG	JFG
545968(G)	TOYOTA COROLLA E140 J 2008 -->	AVD	JFD
545972(G)	NISSAN JUKE	AVG	JFG
545973(G)	NISSAN JUKE	AVD	JFD
545975(G)	TOYOTA RAV 4 III	AVG	JFG
545976(G)	TOYOTA RAV 4 III	AVD	JFD
545978(G)	NISSAN MICRA 4	AVG	JFG
545979(G)	NISSAN MICRA 4	AVD	JFD
545990(G)	HYUNDAI / KIA: IX35 / SPORTAGE	AVD	JFD
545991(G)	HYUNDAI ELANTRA 2	AVG	JFG
545992(G)	HYUNDAI ELANTRA 2	AVD	JFD

SIAAM	Modèle / Model	Position	Type de fixation / Mounting Type
545993(G)	KIA ELANTRA 2	AVG	JFG
545994(G)	KIA CERATO 3 / FORTE 2	AVD	JFD
545996(G)	HYUNDAI GRAND I10	AVG	JFG
545997(G)	HYUNDAI GRAND I10	AVD	JFD
545999(G)	HYUNDAI / KIA: IX35 / SPORTAGE	AVG	JFG
555518(G)	FORD COUGAR	AR	JF
745658(G)	SSONGYONG MUSSO	AV	PLL
745663(G)	HYUNDAI TERRACAN	AV	PLL
755664(G)	HYUNDAI TERRACAN	AR	PLL



---

**RÉFÉRENCES  
ALTERNATIVES  
ALTERNATIVE  
REFERENCES**

---

[www.sia-am.com](http://www.sia-am.com)

Ancienne / Old SIAAM	Nouvelle / New SIAAM	Type de fixation / Mounting Type	Position	Modèle / Model	Application
248154	245012(G)	GC	AV	ISUZU	D-MAX / RODEO / TFR / TFS
218155	215013(G)	GC	AR	ISUZU	D-MAX / RODEO / TFR / TFS
348428	345014(G)	SR	AV	ISUZU	D-MAX AV. AN. 2004
218429	215015(G)	GC	AR	ISUZU	D-MAX AR. AN. 2004
548515	545016(G)	JFG	AVG	CHEVROLET / DAEWOO	CHEVROLET OPTRA / DAEWOO LACETTI
548516	545017(G)	JFD	AVD	CHEVROLET / DAEWOO	CHEVROLET OPTRA / DAEWOO LACETTI
558517	555018(G)	JFG	ARG	CHEVROLET / DAEWOO	CHEVROLET OPTRA / DAEWOO LACETTI
558518	555019(G)	JFD	ARD	CHEVROLET / DAEWOO	CHEVROLET OPTRA / DAEWOO LACETTI
248669	245010(G)	GC	AV	MAZDA	B2500-B2900 4*4 AV.
218660	215021(G)	GC	AR	MAZDA	B2500-B2900 4*4 AR.
148678	145022(G)	SC	AV	FORD / MAZDA	FORD RANGER - MAZDA B2200 4x2
148688	145023(G)	SC	AV	MITSUBISHI	L200 K62T-K64T-K65T
118689	115024(G)	SC	AR	MITSUBISHI	L200 K62T-K64T-K65T
248680	245025(G)	GC	AV	TOYOTA	HI-ACE III & IV 4*4 AV.
238691	235026(G)	GC	AR	TOYOTA	HI-ACE III & IV 4*4 AR.
248692 248694	245027(G)	GC	AV	TOYOTA	TOYOTA HI-ACE V 4*2 & 4*4 AV TOYOTA HI-ACE III & IV 4*2 AV
218693	215028(G)	GC	AR	TOYOTA	HI-ACE V 4*2 & 4*4 AR
238695	235029(G)	GC	AR	TOYOTA	HI-ACE IV 2400- 2700
218696	215020(G)	GC	AR	TOYOTA	HI-LUX KUN 25 4*4
218697	215031(G)	GC	AR	TOYOTA	HI-ACE III 4*2 AR.
248788	245032(G)	GC	AV	HYUNDAI	H100
749193P	745033(G)	PLL	AV	MAZDA	MAZDA B2200-B2500-B2600 Pick-Up
719192T	715034(G)	PLL	AR	MAZDA	MAZDA B2200-B2500-B2600 Pick-Up







---











**TABLEAU DES  
APPLICATIONS**  
TABLE OF  
APPLICATIONS

---



















MODELE MODEL	ANNEE / YEAR						
		AVANT / FRONT			ARRIÈRE / REAR		
		GAZ / GAS	HYD	TYPE	GAZ / GAS	HYD	TYPE



## ALFA ROMEO

ALFA 6							
(119) 	79 »	144134G	144134	SC			
ALFA 33							
(905, 907) 	83 » 95				154026G	154026	SC
ALFA 75							
(162) 	85 » 93	144956G	144956	SC	174957G	174957	SC
ALFA 90							
(162) 	84 » 90	144956G	144956	SC	174957G	174957	SC
ALFA 145,146							
(930) 	94 »				215160G	215160	GC
ALFA 155							
(167) 	<sup>(1)</sup> 91 » 03.95				114059G	114059	SC
Except 2.0 Turbo  2.5 (V6, TD)							
(167) 2.5 V6, 2.5 TD	<sup>(1)</sup> 91 » 03.95				215160G	215160	GC
ALFA 164							
(164) 	<sup>(1)</sup> 87 »				<sup>(2)</sup> 555143G	<sup>(2)</sup> 555143	JF
ALFA - SUD							
(901) 	71 » 85				154211G	154211	SC
ALFA - SUD SPRINT , SPRINT VELOCE							
(902) 	76 » 90				154211G	154211	SC
Except Sprint Ti, Quadrifoglio							
ALFA - SUD SPRINT							
(902) Sprint Ti, Quadrifoglio (Suspension = ALFA 33)	84 » 90				154026G	154026	SC



MODELE MODEL	ANNEE / YEAR						
		AVANT / FRONT			ARRIÈRE / REAR		
		GAZ / GAS	HYD	TYPE	GAZ / GAS	HYD	TYPE
<b>ALFETTA</b>							
(116)  Except GT, GTV	72 »	144134G	144134	SC	174135G	174135	SC
(116) GT, GTV, V6	74 »	144134G	144134	SC	174135G	174135	SC
(116) GT, GTV	12.84 » 89	144956G	144956	SC	174957G	174957	SC
<b>ARNA</b>							
(920) 	84 » 86				155129G	155129	SC
<b>GIULIA</b>							
 Except Spider	58 » 65	141408G	141408	SC		171408	SC
SPIDER	62 » 65		161371	SC		151372	SC
 (Spider inclus)	66 » 80	141408G	141408	SC	171636G	171636	SC
<b>GIULIETTA</b>							
(113) 	55 » 67		161371	SC		151372	SC
(113)  GT, GTV, Spider inclus	68 » 76	141408G	141408	SC	171636G	171636	SC
(116) 	77 » 86	144134G	144134	SC		174135	SC
<b>GIULIETTA 940</b>							
	10 »	545806G L	545806 L	JF	755808G	755808	PLL
	10 »	545807G R	545807 R	JF	755808G	755808	PLL
(116) 	12.84 » 89	144956G	144956	SC	174957G	174957	SC
<b>GTV</b>							
(116) 	74 » 11.84	144134G	144134	SC		174135	SC
<b>MITO</b>							
(955) 	08 »	545789G L 545780G R	545789 L 545780 R	JF	155791G	155791	SC
<b>MONTREAL</b>							
	72 » 76	141408G	141408	SC	171636G	171636	SC
<b>SPIDER</b>							
(115) 	68 » 93	141408G	141408	SC	171636G	171636	SC
<b>ZAGATO</b>							
	72 » 76	141408G	141408	SC	171636G	171636	SC





MODELE MODEL	ANNEE / YEAR						
		AVANT / FRONT			ARRIÈRE / REAR		
		GAZ / GAS	HYD	TYPE	GAZ / GAS	HYD	TYPE





## ALPINE RENAULT

A 110							
1100, 1100 L - 1300, 1300 L - 1600, 1600 S 4 Amortisseurs à l'arrière/4 Shocks on the Rear	65 » 75	141118G	141118	SC	151121G	151121	SC
A 110 B							
1600  = A 310	72 »	141118G	141118	SC			
R5							
R5 Alpine (R 1223) - R5 Alpine Turbo	76 »	244515G	244515	GC	254516G	254516	GC

























## ARO

ARO 4x4							
ARO 10							
100 - 101 - 103 - 104 	79 »				214892G	214892	GC
ARO 24							
240 - 241 - 243 - 244	76 »	744832G	744832	PLL	714833G	714833	PLL
M 461 C							
	» 75	204213G	204213	GC	204213G	204213	GC



















## AUDI

AUDI 50							
(86) L, LS, GT  → 8672376928	73 » 07.75	444492G	444492	FU			
(86) L, LS, GT  8672376929 →	08.75 » 78	444492G	444492	FU	354493G	354493	SR
AUDI 60							
60 L - 60 Variant - F 103	65 » 07.67	141600G	141600	SC	151588G	151588	SC
AUDI 70							
72 L - 72 Variant - 75 - 90	08.67 » 03.68	141600G	141600	SC	151588G	151588	SC
AUDI 80							
	72 » 08.78	444126G	444126	FU		354127	SR
 Variant	75 » 08.78	444126G	444126	FU		114242	SC

















MODELE MODEL	ANNEE / YEAR						
		AVANT / FRONT			ARRIÈRE / REAR		
		GAZ / GAS	HYD	TYPE	GAZ / GAS	HYD	TYPE
<b>AUDI 80</b>							
(81,85, 89, 8A, B2, B3)  Avant  Except  , Quattro	09.78 » 08.91	444869G	444869	FU	354620G	354620	SR
(81, 85, 89, 8A, B2, B3)  Avant  Except Quattro	09.78 » 08.91	444869G	444869	FU			
(81, 85, 89, 8A, B2, B3)  Quattro Except 	82 » 08.86				455140G	455140	FU
(81, 85, 89, 8A, B2, B3)  Quattro Except 	09.86 » 08.91	444869G	444869	FU	455140G	455140	FU
(81, 85, 89, 8A, B2, B3)  Quattro 	84 » 08.86				455348G	455348	FU
(81, 85, 89, 8A, B2, B3)  Quattro 	09.86 » 08.93	444869G	444869	FU	455348G	455348	FU
(8C, B4)  Avant  Except (SS), Quattro , RS2 , S2	09.91 » 96	445107G	445107	FU	355108G	355108	SR
(8C, B4)  Avant (SS) Except S2, RS2	09.91 » 96	445107G	445107	FU			
(8C, B4)  Avant Quattro Except S2, RS2	09.91 » 96	445107G	445107	FU			
(8C, B4) 	91 » 00	445107G	445107	FU			
<b>AUDI 90</b>							
	67 » 03.68		141600	SC		151588	SC
 Except  , Quattro	84 » 91	444869G	444869	FU	354620G	354620	SR
2.3  Except Quattro	84 » 91	444869G	444869	FU	354800G	354800	SR

















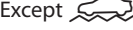





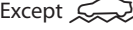

MODELE MODEL	ANNEE / YEAR						
		AVANT / FRONT			ARRIÈRE / REAR		
		GAZ / GAS	HYD	TYPE	GAZ / GAS	HYD	TYPE
<b>AUDI 90</b>							
(81, 85, 89, 8A, B2, B3) Quattro Except 	84 » 91	444869G	444869	FU	455140G	455140	
(81, 85, 89, 8A, B2, B3) Quattro 	84 » 91	444869G	444869	FU	455348G	455348	FU
<b>AUDI Super 90</b>							
Variant inclus.	04.68 » 72		141600	SC		151588	SC
<b>AUDI 100</b>							
(C1)  S, LS, GL	68 » 07.73					151917	SC
(C1)  S  → 41001790	68 » 07.73					151917	SC
(43, C2) 	09.76 » 08.82	444740G	444740	FU	254772G	254772	GC
(44, C3)   Except Quattro	09.82 » 10.90	444740G	444740	FU	<sup>(1)</sup> 354787G	<sup>(1)</sup> 354787	SR
(44, C3)  Quattro	09.82 » 10.90	444740G	444740	FU	<sup>(1)</sup> 355353G	<sup>(1)</sup> 355353	SR
(4A, C4)  Except  , Quattro, S4	11.90 » 94	444740G	444740	FU	<sup>(1)</sup> 354787G	<sup>(1)</sup> 354787	SR
(4A, C4)  (+)  Except Quattro, S4	11.90 » 94	444740G	444740	FU	354910G	354910	SR
(4A, C4)  Quattro Except  , S4	11.90 » 94	444740G	444740	FU	<sup>(1)</sup> 355353G	<sup>(1)</sup> 355353	SR
(4A, C4)  Quattro,  Except S4	11.90 » 94	444740G	444740	FU			











MODELE MODEL	ANNEE / YEAR						
		AVANT / FRONT			ARRIÈRE / REAR		
		GAZ / GAS	HYD	TYPE	GAZ / GAS	HYD	TYPE
<b>AUDI 100</b>							
(44, C3)  Avant  Except Quattro	09.82 » 09.91	444740G	444740	FU	<sup>(1)</sup> 354787G	<sup>(1)</sup> 354787	SR
(44, C3)  Avant Quattro	09.82 » 09.91	444740G	444740	FU	<sup>(1)</sup> 355353G	<sup>(1)</sup> 355353	SR
(4A, C4)  Avant Except (SS), Quattro, S4	10.91 » 94	444740G	444740	FU	<sup>(1)</sup> 354787G	<sup>(1)</sup> 354787	SR
(4A, C4)  Avant (+) (SS) Except Quattro, S4	10.91 » 94	444740G	444740	FU			SR
(4A, C4)  Avant Quattro Except (SS), S4	10.91 » 94	444740G	444740	FU	<sup>(1)</sup> 355353G	<sup>(1)</sup> 355353	SR
(4A, C4)  Avant Quattro (SS) Except S4	10.91 » 94	444740G	444740	FU	354910G	354910	SR
<b>AUDI 200</b>							
(43, C2) 	80 » 82	444740G	444740	FU	254772G	254772	GC
(44, C3)  Except Quattro	83 » 91	444740G	444740	FU	<sup>(1)</sup> 354787G	<sup>(1)</sup> 354787	SR
(44, C3)  Quattro Except 2.2 220 PS	83 » 91	444740G	444740	FU	<sup>(1)</sup> 355353G	<sup>(1)</sup> 355353	SR
(44, C3) Quattro  Variant Except Sport Suspension	83 » 91	444740G	444740	FU	<sup>(1)</sup> 355353G	<sup>(1)</sup> 355353	SR
<b>AUDI A1</b>							
(8X1)  Except (SS), Quattro, S.Line, S1	10 »	545751G	545751	JF	155567G	155567	SC

























MODELE MODEL	ANNEE / YEAR						
		AVANT / FRONT			ARRIÈRE / REAR		
		GAZ / GAS	HYD	TYPE	GAZ / GAS	HYD	TYPE
<b>AUDI A1</b>							
(8XA)  SPORT BACK Except  , Quattro, S.Line, S1 Except 	12 »	545751G	545751	JF	155567G	155567	SC
<b>AUDI A2</b>							
(8Z)  Except 1.2 TDi,  Except 	99 »	545563G	545563	JF	155564G	155564	SC
(8Z)  Except 1.2 TDi, 	99 »	545501G	545501	JF	155503G	155503	SC
(8Z)  Except 1.2 TDi, 	99 »	545501G	545501	JF	155502G	155502	SC
<b>A3 96 &gt; 04.03</b>							
<b>AUDI A3</b>							
(8L)  Except  , Quattro, S3 Except 	96 » 04.03	545274G <sup>(2)</sup>	545274 <sup>(2)</sup>	JF	155275G <sup>(2)</sup>	155275 <sup>(2)</sup>	SC
(8L)  Except Quattro, S3	96 » 04.03	545274G <sup>(2)</sup>	545274 <sup>(2)</sup>	JF	155464G <sup>(2)</sup>	155464 <sup>(2)</sup>	SC
(8L) 	96 » 04.03	545274G <sup>(2)</sup>	545274 <sup>(2)</sup>	JF			
(8L) Quattro  → 140000 Except  , S3 Except 	97 » 05.99	545274G <sup>(2)</sup>	545274 <sup>(2)</sup>	JF			
(8L) Quattro   → 140000 Except S3	97 » 05.99	545274G <sup>(2)</sup>	545274 <sup>(2)</sup>	JF			
(8L) Quattro  → 140000  Except S3	97 » 05.99	545274G <sup>(2)</sup>	545274 <sup>(2)</sup>	JF			



































MODELE MODEL	ANNEE / YEAR						
		AVANT / FRONT			ARRIÈRE / REAR		
		GAZ / GAS	HYD	TYPE	GAZ / GAS	HYD	TYPE
<b>AUDI 05.03 &gt; 08.12</b>							
<b>AUDI A3</b>							
(8P)  Sportback  Tube Jambe de Force : Ø Externe = 50mm. Strut outer Tube : External Ø (OD) = 50mm. Except (SS), Quattro Except 	05.03 » 09.12	545611G	545611	JF	255613G	255613	GC
(8P)  Sportback  Tube Jambe de Force : Ø Externe = 55mm. Strut outer Tube : External Ø (OD) = 55mm. Except (SS), Quattro Except 	05.03 » 09.12	545612G	545612	JF	255613G	255613	GC
(8P)  (Sport-Back) Tube Jambe de Force : Ø Externe = 50mm. Strut outer Tube : External Ø (OD) = 50mm. (SS), Except Quattro	05.03 » 09.12				255613G	255613	GC
(8P)  Sportback Tube Jambe de Force : Ø Externe = 55mm. Strut outer Tube : External Ø (OD) = 55mm. (+) (SS) Except Quattro	05.03 » 09.12				255613G	255613	GC
(8P)  Sportback Quattro (+) (SS) Except S3	03 » 09.12	545612G	545612	JF	255613G	255613	GC





























MODELE MODEL	ANNEE / YEAR						
		AVANT / FRONT			ARRIÈRE / REAR		
		GAZ / GAS	HYD	TYPE	GAZ / GAS	HYD	TYPE
<b>AUDI A3 09.12 &gt;</b>							
<b>AUDI A3</b>							
(8V)   Sportback Tube Jambe de Force: Ø Externe = 50mm. Strut outer Tube: External Ø (OD) = 50mm. Except  ,  , Quattro, S.Line, S3 Except 	(4) 10.12 »	545809G	545809	JF	255911G	255911	GC
(8V)   Sportback Tube Jambe de Force: Ø Externe = 55mm. Strut outer Tube: External Ø (OD) = 55mm. Except  Except  , Quattro, S.Line, S3 Except 	(4) 10.12 »	545800G	545800	JF	255911G	255911	GC
(8V)   Sportback Tube Jambe de Force: Ø Externe = 50mm. Strut outer Tube: External Ø (OD) = 50mm. Suspension Arrière  Except  , Quattro S.Line, S3 Except 	(4) 10.12 »	545809G	545809	JF	255924G	255924	GC
(8V)   Sportback Tube Jambe de Force: Ø Externe = 55mm. Strut outer Tube: External Ø (OD) = 55mm. Suspension Arrière  Except  , Quattro, S.Line, S3 Except 	(4) 10.12 »	545800G	545800	JF	255924G	255924	GC



























MODELE MODEL	ANNEE / YEAR						
		AVANT / FRONT			ARRIÈRE / REAR		
		GAZ / GAS	HYD	TYPE	GAZ / GAS	HYD	TYPE
<b>AUDI A4 Berline / Saloon / Break/Estate / Avant: 94 &gt; 01.99</b>							
<b>AUDI A4</b>							
(8D,B5)   Avant  (  ) → 8D_X_199999 Except (SS), Quattro Except 	94 » 01.99	(5) 345276G	(5) 345276	SR	355277G	355277	SR
(8D,B5)   Avant (SS) (  ) → 8D_X_199999 Except Quattro Except 	94 » 01.99	(5) 345372G	(5) 345372	SR	355277G	355277	SR
(8D,B5)   Avant Quattro: (  ) → 8D_X_199999 Except (SS), S4,  Except 	94 » 01.99	(5) 345276G	(5) 345276	SR			
(8D,B5)   Avant Quattro (SS) (  ) → 8D_X_199999 Quattro S4 (  ) → 8D_X_199999 Except 	94 » 01.99	(5) 345372G	(5) 345372	SR			
<b>AUDI A4 Berline / Saloon: 02.99 &gt; 10.00 Except Quattro</b>							
<b>AUDI A4</b>							
(8D,B5)   (  ) 8D_X_200000 → 8D-1-030000, Except (SS), Quattro,  Except 	02.99 » 10.00	(5) 345276G	(5) 345276	SR	(5) 355499G	(5) 355499	(5) SR
(8D,B5)   (  ) 8D_1_030001 → Except (SS), Quattro,  Except 	02.99 » 10.00	(5) 345667G	(5) 345667	SR	(5) 355499G	(5) 355499	(5) SR





























MODELE MODEL	ANNEE / YEAR						
		AVANT / FRONT			ARRIÈRE / REAR		
		GAZ / GAS	HYD	TYPE	GAZ / GAS	HYD	TYPE
<b>AUDI A4</b>							
(8D,B5)  SS  8D_X_200000 → 8D-1-030000 Except Quattro,  Except 	02.99 » 10.00	(5) 345276G	(5) 345276	SR	(5) 355499G	(5) 355499	SR
(8D,B5)  SS  8D_1_030001 → Except Quattro  Except 	02.99 » 10.00	(5) 345667G	(5) 345667	SR	(5) 355499G	(5) 355499	SR
<b>AUDI A4 Berline / Saloon Quattro : 02.99 &gt; 10.00</b>							
<b>AUDI A4</b>							
(8D,B5)  Quattro  8D_X_200000 → 8D_1_030000, Except SS, S4,  Except 	02.99 » 10.00	(5) 345276G	(5) 345276	SR			
(8D,B5)  Quattro  8D_1_030001 → Except SS, S4,  Except 	02.99 » 10.00	(5) 345667G	(5) 345667	SR			
(8D,B5)  Quattro SS  8D_X_200000 → 8D_1_030000 Except S4,  Except 	02.99 » 10.00	(5) 345372G	(5) 345372	SR			
(8D,B5)  Quattro SS  8D_1_030001 → Except S4,  Except 	02.99 » 10.00	(5) 345667G	(5) 345667	SR			























MODELE MODEL	ANNEE / YEAR						
		AVANT / FRONT			ARRIÈRE / REAR		
		GAZ / GAS	HYD	TYPE	GAZ / GAS	HYD	TYPE
<b>AUDI A4 Berline / Saloon: 11.00 &gt; 11.07</b>							
<b>AUDI A4</b>							
(8E,B6,B7)  (Quattro inclus.) Except (SS), S4, RS4 Except  	11.00 » 11.07	(5) 345644G	(5) 345644	SR	(5) 155647G	(5) 155647	SC
(8E,B6,B7)  (SS) (Quattro inclus.) Except S4, RS4 Except  	11.00 » 11.07	(5) 345645G	(5) 345645	SR	(5) 155648G	(5) 155648	SC
(8E,B6,B7)  Quattro inclus  Except 	11.00 » 11.07	(5) 345646G	(5) 345646	SR	155649G	155649	SC
<b>AUDI A4 Berline / Saloon: 12.07 &gt;</b>							
<b>AUDI A4</b>							
(8K,B8)  Except (SS) Except Quattro, S.Line, S4, RS4, 	12.07 »	545782G	545782	JF	255783G	255783	GC
<b>AUDI A4 Cabriolet: 02 &gt;</b>							
<b>AUDI A4</b>							
(8H)  (SS) Except 	02 »	(5) 345645G	(5) 345645	SR	(5) 155647G	(5) 155647	SC
<b>AUDI A4 Break/Estate 02.99 &gt; 09.01, Except Quattro</b>							
<b>AUDI A4</b>							
(8D,B5)  Avant  (  8D_X_200000 → 8D-1-030000, Except (SS), Quattro,  Except 	02.99 » 09.01	(5) 345276G	(5) 345276	SR	(5) 355499G	(5) 355499	SR
(8D,B5)  Avant  (  8D_1_030001 → Except (SS), Quattro,  Except 	02.99 » 09.01	(5) 345667G	(5) 345667	SR	(5) 355499G	(5) 355499	SR























MODELE MODEL	ANNEE / YEAR						
		AVANT / FRONT			ARRIÈRE / REAR		
		GAZ / GAS	HYD	TYPE	GAZ / GAS	HYD	TYPE
<b>AUDI A4</b>							
(8D,B5)  Avant (SS)  8D_X_200000 → 8D-1-030000 Except Quattro,  Except 	02.99 » 09.01	(5) 345276G	(5) 345276	SR	(5) 355499G	(5) 355499	SR
(8D,B5)  Avant (SS)  8D_1_030001 → Except Quattro,  Except 	02.99 » 09.01	(5) 345667G	(5) 345667	SR	(5) 355499G	(5) 355499	SR
<b>AUDI A4 Break/Estate Quattro 02.99 &gt; 09.01</b>							
<b>AUDI 4</b>							
(8D,B5)  Avant Quattro  8D_X_200000 → 8D_1_030000 Except (SS), S4,  Except 	02.99 » 09.01	(5) 345276G	(5) 345276	SR			
 Avant Quattro  8D_1_030001 → Except (SS), S4,  Except 	02.99 » 09.01	(5) 345667G	(5) 345667	SR			
(8D,B5)  Avant Quattro (SS)  8D_X_200000 → 8D_1_030000 Except S4,  Except 	02.99 » 09.01	(5) 345372G	(5) 345372	SR			
(8D,B5)  Avant Quattro (SS)  8D_1_030001 → Except S4,  Except 	02.99 » 09.01	(5) 345667G	(5) 345667	SR			















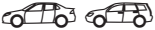



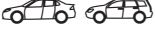













MODELE MODEL	ANNEE / YEAR						
		AVANT / FRONT			ARRIÈRE / REAR		
		GAZ / GAS	HYD	TYPE	GAZ / GAS	HYD	TYPE
<b>AUDI A4 Break/Estate 10.01 &gt; 04.08, Except Allroad</b>							
<b>AUDI A4</b>							
(8E,B6,B7)  Avant  (Quattro inclus.) Except (SS), S4, RS4 Except  Except 	10.01 » 04.08	(5) 345644G	(5) 345644	SR	(5) 155647G	(5) 155647	SC
(8E,B6,B7)  Avant (SS) (Quattro inclus.) Except S4, RS4 Except  Except 	10.01 » 04.08	(5) 345645G	(5) 345645	SR	(5) 155648G	(5) 155648	SC
(8E,B6,B7)  Avant  (Quattro inclus.) Except 	10.01 » 04.08	(5) 345646G	(5) 345646	SR	155649G	155649	SC
<b>AUDI A4 Break/Estate 05.08 &gt;, Except Allroad</b>							
<b>AUDI A4</b>							
(8K, B8)  Avant Except (SS), Quattro, S.Line, S4, RS4, 	05.08 »	(5) 545782G	(5) 545782	JF	(5) 255783G	(5) 255783	GC
<b>AUDI A5</b>							
<b>AUDI A5</b>							
(8T3)  Except (SS), Quattro, S Line, S5, RS5	07 »	545782G	545782	JF	255783G	255783	GC
(8F7)  Except (SS), Quattro, S Line, S5	08 »	545782G	545782	JF	255783G	255783	GC
(8TA)  Sport-back Except Quattro, S Line, S5, RS5	09 »				255783G	255783	GC
<b>AUDI A6 94 &gt; 06.97</b>							
<b>AUDI A6</b>							
(4A,C4)   Avant  Except (SS), Quattro, S6	94 » 06.97	444740G	444740	FU	(1) 354787G	(1) 354787	SR































MODELE MODEL	ANNEE / YEAR						
		AVANT / FRONT			ARRIÈRE / REAR		
		GAZ / GAS	HYD	TYPE	GAZ / GAS	HYD	TYPE
<b>AUDI A6</b>							
(4A,C4)   Avant (+) (SS) Except Quattro, S6	94 » 06.97	444740G	444740	FU	<sup>(1)</sup> 354910G	<sup>(1)</sup> 354910	SR
(4A,C4)   Avant Quattro Except (SS), S6	94 » 06.97	444740G	444740	FU	<sup>(1)</sup> 355353G	<sup>(1)</sup> 355353	SR
(4A,C4)   Avant Quattro (SS) Except S6	94 » 06.97	444740G	444740	FU			
<b>AUDI A6 07.97 &gt; 04.00</b>							
<b>AUDI A6</b>							
(4B,C5)   Avant  (SS) 4B..X.. → N° 070000 Except (SS), Quattro, 2.7 Turbo V6 Except 	07.97 » 12.98	345276G	345276	SR	<sup>(1)</sup> 155373G	<sup>(1)</sup> 155373	SC
(4B,C5)   Avant  (SS) 4B..X.. : N° 070001 → (SS) 4B..Y.. (+) (SS) Except Quattro, 2.7 Turbo V6 Except 	01.99 » 04.00	345372G	345372	SR	<sup>(1)</sup> 155373G	<sup>(1)</sup> 155373	SC
(4B,C5)   Avant (SS) 4B..X.., 4B..Y.. (+) (SS) 2.7 Turbo V6 Except Quattro	07.97 » 04.00	345372G	345372	SR	<sup>(1)</sup> 155373G	<sup>(1)</sup> 155373	SC
(4B,C5)   Avant (SS) 4B..X.., 4B..Y.. Quattro Except 2.7 V6, (SS) S6, (V8) Except 	07.97 » 12.98	345276G	345276	SR			









MODELE MODEL	ANNEE / YEAR						
		AVANT / FRONT			ARRIÈRE / REAR		
		GAZ / GAS	HYD	TYPE	GAZ / GAS	HYD	TYPE
<b>AUDI A6</b>							
(4B,C5)  Avant (  ) 4B..X.., 4B..Y.. Quattro Except 2.7 V6, (  ) S6 (V8) Except 	01.99 » 04.00	345372G	345372	SR			
(4B,C5)  Avant (  ) 4B..X.., 4B..Y.. Quattro 2.7 V6 Except (  ) S6 (V8)	07.97 » 04.00	345372G	345372	SR			
(4B,C5)  Avant (  ) 4B..X.., 4B..Y.. Quattro (  ) Except S6 (V8)	07.97 » 04.00	345372G	345372	SR			
<b>AUDI A6 Berline / Saloon 05.00 &gt; 04.04</b>							
<b>AUDI A6</b>							
(4B,C5)   (  ) 4B..1.. Except (  ) Quattro  Except 	05.00 » 04.04	345667G	345667	SR	<sup>(1)</sup> 155373G	<sup>(1)</sup> 155373	SC
(4B,C5)  (  ) 4B..1.. (  ) Except Quattro  Except 	05.00 » 04.04	345667G	345667	SR	<sup>(1)</sup> 155373G	<sup>(1)</sup> 155373	SC
(4B,C5)  (  ) 4B..1.. Quattro Except S6 (V8)  Except 	05.00 » 04.04	345667G	345667	SR			
(4B,C5)  (  ) 4B..1.. 	05.00 » 04.04	345680G	345680	SR			















MODELE MODEL	ANNEE / YEAR						
		AVANT / FRONT			ARRIÈRE / REAR		
		GAZ / GAS	HYD	TYPE	GAZ / GAS	HYD	TYPE
<b>AUDI A6 Berline / Saloon 05.04 &gt;</b>							
<b>AUDI A6</b>							
(4F,C6)   (Quattro inclus.) Except (S), S6, RS6,  Except 	05.04 » 03.11	345731G	345731	SR	(1) 255733G	(1) 255733	GC
(4F,C6)  (S) (Quattro inclus.) Except S6, RS6,  Except 	05.04 » 03.11	345732G	345732	SR	(1) 255734G	(1) 255734	GC
<b>AUDI A6 Brake / Estate 05.00 &gt;</b>							
<b>AUDI A6</b>							
(4B,C5)  Avant   4B..1.. Except (S), Quattro,  , Allroad Except 	05.00 » 03.05	345667G	345667	SR	(1) 155373G	(1) 155373	SC
(4B,C5)  Avant  4B..1.. Quattro Except  Except 	05.00 » 03.05	345667G	345667	SR			
(4B,C5)  Avant  4B..1.. 	05.00 » 03.05	345680G	345680	SR			
(4F,C6)  Avant  (Quattro inclus.) Except (S), S6, RS6,  Except 	05.04 » 08.11	345731G	345731	SR	255733G	255733	GC
(4F,C6)  Avant (+) (S) (Quattro inclus.) Except S6, RS6,  Except 	05.04 » 08.11	345732G	345732	SR	255734G	255734	GC















MODELE MODEL	ANNEE / YEAR						
		AVANT / FRONT			ARRIÈRE / REAR		
		GAZ / GAS	HYD	TYPE	GAZ / GAS	HYD	TYPE
<b>AUDI ALLROAD &gt; CABRIOLET</b>							
<b>AUDI CABRIOLET</b>							
(8G,B4)  Base/Basis = Audi 80 Except A4	91 »	445107G	445107	FU			
<b>AUDI COUPE &gt; V8</b>							
<b>AUDI COUPE</b>							
(81,85)  Except Quattro	80 » 09.88	444869G	444869	FU	354620G	354620	SR
(89,8B)  Except Quattro, S2	10.88 »	444869G	444869	FU	354800G	354800	SR
(89,8B) Quattro	84 » 09.88	444869G	444869	FU	455140G	455140	FU
(89,8B) Quattro Except S2	10.88 » 07.91	444869G	444869	FU	455348G	455348	FU
(89,8B) Quattro Except S2	08.91 »	445107G	445107	FU	455348G	455348	FU
<b>AUDI V8</b>							
V8	88 » 94	444740G	444740	FU	354927G	354927	SR





## AUSTIN

<b>MAESTRO</b>							
 	84 » 90				154009G	154009	SC
 	90 » 94				114000G	114000	SC
<b>METRO</b>							
 	80 »	144870G	144870	SC			
<b>MINI</b>							
  850 - Cooper - Cooper "S"	59 » 69	101495G	101495	SC		151495	SC
  850 - 1000 (Mayfair) - 1100 - 1275 GT - 1300	60 »	101495G	101495	SC		151495	SC
  Innocenti 90, 120, De Tomaso Except 3 Cyl.	61 »	101495G	101495	SC		151495	SC







MODELE MODEL	ANNEE / YEAR						
		AVANT / FRONT			ARRIÈRE / REAR		
		GAZ / GAS	HYD	TYPE	GAZ / GAS	HYD	TYPE
<b>MINI</b>							
 Clubman - Countryman	62 »	101495G	101495	SC		154688	SC
<b>AUTOBIANCHI</b>							
<b>264 , 320</b>							
	57 »		161350	SC		171361	SC
<b>A111</b>							
	64 »		141806	SC		111807	SC
<b>A112</b>							
 (  ) 47201 →	69 » 88		544659	JF	554851G	554851	JF
<b>ADRIA</b>							
ADRIA			121572	SC		131573	SC
<b>BIANCHINA</b>							
Panoramica 120 B , 120F	57 »		161350	SC		171361	SC
<b>GIARDINIERA</b>							
120F	57 »		161350	SC		171361	SC
<b>LUTECE</b>							
LUTECE	57 »		161350	SC		171361	SC
<b>PRIMULA</b>							
Primula 65 C  S	64 »		141806	SC		111807	SC
<b>Y10</b>							
	85 » 12.92				114970G	114970	SC
	01.93 » 96				115257G	115257	SC
	85 » 12.92				114916G	114916	SC
<b>BEDFORD</b>							
<b>ASTRA</b>							
Max	85 »	444640G	444640	FU	114050G	114050	SC
	82 » 91	444640G	444640	FU	134652G	134652	SC
	91 » 98	445156G	445156	FU	134652G	134652	SC
<b>CF</b>							
14 - 18 - 22 - 25 - 35	69 » 75	264243G	264243	GC	214244G	214244	GC
220 - 250 - 280	76 » 82	264243G	264243	GC	214244G	214244	GC
340	76 »	264243G	264243	GC	214244G	214244	GC
350	76 »	264243G	264243	GC			











MODELE MODEL	ANNEE / YEAR						
		AVANT / FRONT			ARRIÈRE / REAR		
		GAZ / GAS	HYD	TYPE	GAZ / GAS	HYD	TYPE
<b>CF</b>							
230 - 250 - 280 AV/F: †	83 »	264243G	264243	GC	214880G	214880	GC
230 - 250 - 280 AV/F: †	83 »	244065G	244065	GC	214880G	214880	GC
18 - 22 - 25 CWT AV/F: †	84 »	264243G	264243	GC	204587G	204587	GC
18 - 22 - 25 CWT AV/F: †	83 »	244065G	244065	GC	204587G	204587	GC
35 CWT AV/F: †	83 »	264243G	264243	GC	214244G	214244	GC
35 CWT AV/F: †	83 »	244065G	244065	GC	214244G	214244	GC
97170, 97370 AV/F: †		264243G	264243	GC	204587G	204587	GC
97170, 97370 AV/F: †		244065G	244065	GC	204587G	204587	GC
97760, 97K60 AV/F: †		264243G	264243	GC	214244G	214244	GC
97760, 97K60 AV/F: †		244065G	244065	GC	214244G	214244	GC
<b>KB</b>							
	80 »	144850G	144850	SC	214880G	214880	GC
<b>MIDI</b>							
	85 »		144083	SC		214070	GC
	85 »					214070	GC









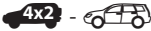

## BMW

<b>1 - E81</b>							
 Except (SS) <b>M-Tech</b>	06 » 11.11	545755G L 545756G R	545755 L 545756 R	JF	275757G	275757	GC
<b>1 - E87</b>							
 Except (SS) <b>M-Tech</b>	03 » 11.10	545755G L 545756G R	545755 L 545756 R	JF	275757G	275757	GC
<b>1 - E82</b>							
 Except (SS) <b>M-Tech</b>	07 » 09.13	545755G L 545756G R	545755 L 545756 R	JF	275757G	275757	GC
<b>1 - E88</b>							
 Except (SS) <b>M-Tech</b>	08 » 11.10	545755G L 545756G R	545755 L 545756 R	JF	275757G	275757	GC
<b>3 - E21</b>							
Tube Jambe de force: Ø externe = 46 mm Strut Outer Tube : external Ø (OD) = 46 mm 315	75 » 84	444468G	444468	FU	354469G	354469	SR

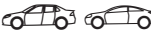

MODELE MODEL	ANNEE / YEAR						
		AVANT / FRONT			ARRIÈRE / REAR		
		GAZ / GAS	HYD	TYPE	GAZ / GAS	HYD	TYPE
<b>3 - E21</b>							
Tube Jambe de force: Ø externe = 46 mm Strut Outer Tube : external Ø (OD) = 46 mm 316 - 318 - 318 A - 318i - 320 - 320A - 320i - 320/6	75 » 08.82	444468G	444468	FU	354469G	354469	SR
<b>3- E21</b>							
Tube Jambe de force: Ø externe = 52 mm Strut Outer Tube : external Ø (OD) = 52mm 320/6 - 323i - 3 (SS)	77 » 08.82	444812G	444812	FU	354469G	354469	SR
<b>3 - E30</b>							
 316, 316i, 318i, 318iS, 320i, 324d Except (SS) , <b>M-Tech</b> Tube Jambe de Force : Ø externe = 46 mm Strut Tube: external Ø (OD) = 46 mm	09.82 » 08.90	444924G	444924	FU	<sup>(1)</sup> 154925G	<sup>(1)</sup> 154925	SC
 Tube Jambe de Force : Ø externe = 52 mm Strut Tube : external Ø (OD) = 52 mm 316 Sport, 316i Sport, 318i Sport, 318iS Sport 320i Sport, 320iS Sport, 323i, 323i Sport, 324d Sport, 324td, 324td Sport, 325e, 325e Sport, 325i, 325i Sport Except  <b>M-Tech</b>	09.82 » 08.90	444926G	444926	FU	<sup>(1)</sup> 154925G	<sup>(1)</sup> 154925	SC
 325iX Except <b>M-Tech</b>	85 » 91				<sup>(1)</sup> 154925G	<sup>(1)</sup> 154925	SC
 318i - 318i Sport - 320i - 320i Sport - 325i - 325i Sport Except <b>M-Tech</b>	86 » 04.93	444926G	444926	FU	<sup>(1)</sup> 154925G	<sup>(1)</sup> 154925	SC
 316i, 318i, Except (SS) <b>M-Tech</b>	03.89 » 09.89	444924G	444924	FU	<sup>(1)</sup> 154925G	<sup>(1)</sup> 154925	SC
 316i, 318i, Except <b>M-Tech</b> (SS)	10.89 » 03.95	444926G	444926	FU	<sup>(1)</sup> 154925G	<sup>(1)</sup> 154925	SC

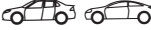
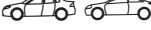

MODELE MODEL	ANNEE / YEAR						
		AVANT / FRONT			ARRIÈRE / REAR		
		GAZ / GAS	HYD	TYPE	GAZ / GAS	HYD	TYPE
<b>3 - E30</b>							
 Except <b>M-Tech</b> 318iS - 318i Sport - 320 - 320 Sport - 320i - 320iS - 320i Sport - 324td - 324td Sport - 325i - 325iS - 325i Sport	87 » 03.95	444926G	444926	FU	(1) 154925G	(1) 154925	SC
<b>X1</b>							
(E84) 	09 » 06.15				275835G		GC
<b>Z1</b>							
 Roadster	89 » 92	444926G	444926	FU	154925G	154925	SC
<b>Z4</b>							
	09 »	545832G 545833G		JF	275834G		GC
<b>BMW 3 SERIES : E36 Compact: 91 &gt; 99</b>							
<b>3 - E36</b>							
Compact 316i - 318iS - 318ti - 318tds Except <b>M-Tech</b>	94 » 05.01	(2) 545248G L 545249G R	(2) 545248 L 545249 R	JF	255254G	255254	GC
<b>BMW 3 SERIES : E36 Berline / Saloon &amp; Coupé</b>							
<b>BMW</b>							
 316i - 318i - 318iS Except <b>M-Tech</b>	09.90 » 05.92	(2) 545246G L 545247G R	(2) 545246 L 545247 R	JF	155186G	155186	SC
 316 - 316i - 318i - 318iS - 318tds Except <b>M-Tech</b>	06.92 » 02.98	(2) 545248G L 545249G R	(2) 545248 L 545249 R	JF	155186G	155186	SC
 320i - 324d - 324td - 325i - 325td Except <b>M-Tech</b>	09.90 » 05.92	(2) 545240G L 545251G R	(2) 545240 L 545251 R	JF	255258G	255258	GC
 320i - 324d - 324td - 325i - 325td - 325tds Except <b>M-Tech</b>	06.92 » 02.95	(2) 545252G L 545253G R	(2) 545252 L 545253 R	JF	255258G	255258	GC
 320i - 323i - 325i - 325td - 325tds - 328i Except <b>M-Tech</b>	03.95 » 02.98	(2) 545248G L 545249G R	(2) 545248 L 545249 R	JF	255258G	255258	GC
 316 - 316i - 318i - 318iS - 318tds Except <b>M-Tech</b>	06.92 » 02.99	(2) 545248G L 545249G R	(2) 545248 L 545249 R	JF	155186G	155186	SC







MODELE MODEL	ANNEE / YEAR						
		AVANT / FRONT			ARRIÈRE / REAR		
		GAZ / GAS	HYD	TYPE	GAZ / GAS	HYD	TYPE
<b>BMW</b>							
 320i - 323i - 325i - 325td - 325tds - 328i Except <b>M-Tech</b>	03.95 » 02.99	(2) 545248G L 545249G R	(2) 545248 L 545249 R	JF	255258G	255258	GC
<b>BMW 3 SERIES : E36 Cabriolet</b>							
<b>BMW</b>							
 318i Except <b>M-Tech</b>	05.93 » 01.95	(2) 545252G L 545253G R	(2) 545252 L 545253 R	JF	255258G	255258	GC
 318i Except <b>M-Tech</b>	02.95 » 03.00	(2) 545248G L 545249G R	(2) 545248 L 545249 R	JF	255258G	255258	GC
 320i - 323i - 325i - 328i Except <b>M-Tech</b>	05.93 » 03.00	(2) 545252G L 545253G R	(2) 545252 L 545253 R	JF	255258G	255258	GC
<b>BMW 3 SERIES : E36 Break/Estate</b>							
<b>BMW</b>							
 316i - 318i - 318tds - 320i - 323i - 325i - 325tds - 328i Except <b>M-Tech</b>	04.95 » 06.99	(2) 545248G L 545249G R	(2) 545248 L 545249 R	JF			
<b>BMW 3 SERIES : E46 Compact</b>							
<b>3 - E46</b>							
 COMPACT (+) (SS) 316ti - 318ti - 318td	06.01 »	545402G L 545403G R	545402 L 545403 R	JF	155620G	155620	SC
 COMPACT (+) (SS) inclus 320td - 325ti	06.01 »	545628G L 545629G R	545628 L 545629 R	JF	155620G	155620	SC
<b>BMW 3 SERIES : E46 Berline / Saloon 03.98 &gt; 03.01 ou / or 08.01</b>							
<b>BMW</b>							
  316i - 318i - 320i - 320d - 323i - 325i - 328i Except (SS), M-Sport Pack II Except 	03.98 » 08.01	545490G L 545401G R	545490 L 545401 R	JF	155404G	155404	SC
  (SS)  316i - 318i - 320i - 320d - 323i - 325i - 328i Except M-Sport Pack II	03.98 » 08.01	545402G L 545403G R	545402 L 545403 R	JF	155620G	155620	SC





MODELE MODEL	ANNEE / YEAR						
		AVANT / FRONT			ARRIÈRE / REAR		
		GAZ / GAS	HYD	TYPE	GAZ / GAS	HYD	TYPE
<b>BMW</b>							
  330i - 330d Except (SS) M-Sport Pack II Except 	03.98 » 03.01	545490G L 545401G R	545490 L 545401 R	JF	155620G	155620	SC
  (SS)  330i - 330d Except M-Sport Pack II	03.98 » 08.01	545402G L 545403G R	545402 L 545403 R	JF	155620G	155620	SC
  M-Sport Pack II 316i - 318i - 318d - 320i - 320d - 325i -330i - 330d	03.98 » 02.05	545628G L 545629G R	545628 L 545629 R	JF	155630G	155630	SC
<b>BMW 3 SERIES : E46 Berline / Saloon 04.01 ou / or 09.01 &gt; 02.05</b>							
<b>BMW</b>							
  316i - 318i - 318d - 320i - 320d - 325i Except (SS) M-Sport Pack II Except 	09.01 » 02.05	545402G L 545403G R	545402 L 545403 R	JF	155404G	155404	SC
  (SS)  316i - 318i - 318d Except M-Sport Pack II	09.01 » 02.05	545402G L 545403G R	545402 L 545403 R	JF	155620G	155620	SC
  (SS)  320i - 320d - 325i Except M-Sport Pack II	09.01 » 02.05	545628G L 545629G R	545628 L 545629 R	JF	155620G	155620	SC
  (+) (SS) Susp. Mauvaises Routes/Rough Roads 330i - 330d Except M-Sport Pack II	04.01 » 02.05	545628G L 545629G R	545628 L 545629 R	JF	155620G	155620	SC
  M-Sport Pack II 316i - 318i - 318d - 320i - 320d - 325i -330i - 330d	03.98 » 02.05	545628G L 545629G R	545628 L 545629 R	JF	155630G	155630	SC
<b>BMW 3 SERIES : E46 Coupé: 03.99 &gt; 03.01 ou / or 08.01</b>							
<b>BMW</b>							
  (+) (SS) 316Ci - 318Ci Except M-Sport Pack II, M3	03.99 » 08.06	545402G L 545403G R	545402 L 545403 R	JF	155620G	155620	SC



MODELE MODEL	ANNEE / YEAR						
		AVANT / FRONT			ARRIÈRE / REAR		
		GAZ / GAS	HYD	TYPE	GAZ / GAS	HYD	TYPE
<b>BMW</b>							
  (+) (SS) 320Ci - 323Ci - 325Ci - 328Ci Except M-Sport Pack II, M3	03.99 » 08.01	545402G L 545403G R	545402 L 545403 R	JF	155620G	155620	SC
  330Ci Except (SS), M-Sport Pack II, M3	03.99 » 03.01	545402G L 545403G R	545402 L 545403 R	JF	155620G	155620	SC
  (+) (SS) 330Ci Except M-Sport Pack II, M3	03.99 » 08.01	545402G L 545403G R	545402 L 545403 R	JF	155620G	155620	SC
  (+) (SS) 320Ci - 320Cd - 325Ci Except M-Sport Pack II, M3	09.01 » 08.06	545628G L 545629G R	545628 L 545629 R	JF	155620G	155620	SC
  330Ci - 330Cd Except (SS), M-Sport Pack II, M3	04.01 » 08.06	545628G L 545629G R	545628 L 545629 R	JF	155620G	155620	SC
  (+) (SS) 330Ci - 330Cd, Except M-Sport Pack II, M3	09.01 » 08.06	545628G L 545629G R	545628 L 545629 R	JF	155620G	155620	SC
  M-Sport Pack II 316Ci - 318Ci - 320Ci - 325Ci - 330Ci Except M3	11.00 » 08.06	545628G L 545629G R	545628 L 545629 R	JF	155630G	155630	SC
<b>BMW 3 SERIES : E46 Cabriolet</b>							
<b>BMW</b>							
  318Ci - 320Ci - 320Cd - 323Ci - 325Ci - 330Ci Except (SS) M-Sport Pack II, M3 Except 	04.00 » 02.07	545490G L 545401G R	545490 L 545401 R	JF	155620G	155620	SC
  (+) (SS)  318Ci - 320Ci - 320Cd - 323Ci - 325Ci Except M-Sport Pack II, M3	04.00 » 02.07	545402G L 545403G R	545402 L 545403 R	JF	155620G	155620	SC
  (+) (SS)  330Ci - 330Cd Except M-Sport Pack II, M3	04.00 » 02.07	545402G L 545403G R	545402 L 545403 R	JF	155630G	155630	SC

















MODELE MODEL	ANNEE / YEAR						
		AVANT / FRONT			ARRIÈRE / REAR		
		GAZ / GAS	HYD	TYPE	GAZ / GAS	HYD	TYPE
<b>BMW</b>							
  M-Sport Pack II 318Ci - 320Ci - 325Ci - 330Ci Except M3	04.00 » 02.07	545628G L 545629G R	545628 L 545629 R	JF	155630G	155630	SC
<b>BMW 3 SERIES : E46 Break/Estate / Touring</b>							
<b>BMW</b>							
  316i - 318i - 320i - 320d - 325i - 328i - 330i - 330d Except (SS), M-Sport Pack II Except 	07.99 » 08.05	545490G L 545401G R	545490 L 545401 R	JF	155620G	155620	SC
  (+) (SS)  316i - 318i - 318d - 320i - 320d - 325i - 328i - 330i - 330d Except M-Sport Pack II	07.99 » 08.05	545402G L 545403G R	545402 L 545403 R	JF	155630G	155630	SC
  M-Sport Pack II 318i - 320i - 320d - 325i - 328i - 330i - 330d	07.99 » 08.05	545628G L 545629G R	545628 L 545629 R	JF	155630G	155630	SC
<b>BMW 3SERIES : E90</b>							
<b>3 - E90</b>							
 Except (SS) <b>M-Tech</b> Except 	03.05 » 10.11	545755G L 545756G R	545755 L 545756 R	JF	275757G	275757	GC
<b>3 - E92</b>							
 Except (SS) <b>M-Tech</b> Except 	09.06 » 09.12	545755G L 545756G R	545755 L 545756 R	JF	275757G	275757	GC
<b>3 - E93</b>							
 Except (SS) <b>M-Tech</b> Except 	03.07 » 09.12	545755G L 545756G R	545755 L 545756 R	JF	275757G	275757	GC
<b>3 - E91</b>							
 /Touring Except (SS) <b>M-Tech</b> Except 	09.05 » 09.12	545755G L 545756G R	545755 L 545756 R	JF	275757G	275757	GC
<b>5 - E12</b>							
518  → 4 632 973	74 » 07.76	444760G <sup>(3)</sup>	444760 <sup>(3)</sup>	FU	354448G	354448	SR
520  → 4 717 725	72 » 07.76	444760G <sup>(3)</sup>	444760 <sup>(3)</sup>	FU	354448G	354448	SR















MODELE MODEL	ANNEE / YEAR						
		AVANT / FRONT			ARRIÈRE / REAR		
		GAZ / GAS	HYD	TYPE	GAZ / GAS	HYD	TYPE
<b>5 - E12</b>							
520A  → 4 413 736	72 » 07.76	444760G <sup>(3)</sup>	444760 <sup>(3)</sup>	FU	354448G	354448	SR
520i  → 4 454 062	72 » 07.76	444760G <sup>(3)</sup>	444760 <sup>(3)</sup>	FU	354448G	354448	SR
518  4 632 974 →	08.76 » 07.81	444760G <sup>(3)</sup>	444760 <sup>(3)</sup>	FU	354771G	354771	SR
518i	08.76 » 07.81	444760G <sup>(3)</sup>	444760 <sup>(3)</sup>	FU	354771G	354771	SR
520  4 717 726 →	08.76 » 07.81	444760G <sup>(3)</sup>	444760 <sup>(3)</sup>	FU	354771G	354771	SR
520A  4 413 737 →	08.76 » 07.81	444760G <sup>(3)</sup>	444760 <sup>(3)</sup>	FU	354771G	354771	SR
520i  4 454 063 →	08.76 » 07.81	444760G <sup>(3)</sup>	444760 <sup>(3)</sup>	FU	354771G	354771	SR
520/6	08.76 » 07.81	444760G <sup>(3)</sup>	444760 <sup>(3)</sup>	FU	354771G	354771	SR
525  → 4 829 406	73 » 07.76	444760G <sup>(3)</sup>	444760 <sup>(3)</sup>	FU	354448G	354448	SR
525A  → 4 516 704	73 » 07.76	444760G <sup>(3)</sup>	444760 <sup>(3)</sup>	FU	354448G	354448	SR
528  → 4 757 067	73 » 07.76	444760G <sup>(3)</sup>	444760 <sup>(3)</sup>	FU	354448G	354448	SR
528A  → 4 551 948	73 » 07.76	444760G <sup>(3)</sup>	444760 <sup>(3)</sup>	FU	354448G	354448	SR
530i  → 5 012 010	73 » 07.76	444760G <sup>(3)</sup>	444760 <sup>(3)</sup>	FU	354448G	354448	SR
530iA  → 5 031 674	73 » 07.76	444760G <sup>(3)</sup>	444760 <sup>(3)</sup>	FU	354448G	354448	SR
525 - 525i  4 829 407 →	08.76 » 07.81	444760G <sup>(3)</sup>	444760 <sup>(3)</sup>	FU	354771G	354771	SR
525A  4 516 705 →	08.76 » 07.81	444760G <sup>(3)</sup>	444760 <sup>(3)</sup>	FU	354771G	354771	SR
528  4 757 068 →	08.76 » 07.81	444760G <sup>(3)</sup>	444760 <sup>(3)</sup>	FU	354771G	354771	SR
528A  4 551 949 →	08.76 » 07.81	444760G <sup>(3)</sup>	444760 <sup>(3)</sup>	FU	354771G	354771	SR
528i - 528iA	08.76 » 07.81	444760G <sup>(3)</sup>	444760 <sup>(3)</sup>	FU	354771G	354771	SR
530i  5 012 011 →	08.76 » 07.81	444760G <sup>(3)</sup>	444760 <sup>(3)</sup>	FU	354771G	354771	SR













MODELE MODEL	ANNEE / YEAR						
		AVANT / FRONT			ARRIÈRE / REAR		
		GAZ / GAS	HYD	TYPE	GAZ / GAS	HYD	TYPE
<b>5 - E12</b>							
530iA  5 031 675 →	08.76 » 07.81	(3) 444760G	(3) 444760	FU	354771G	354771	SR
<b>BMW 5 SERIES : E28</b>							
<b>5 - E28</b>							
518 - 518i Except <b>M-Tech</b>	08.81 » 88	444807G	444807	FU	354808G	354808	SR
520i Except <b>M-Tech</b>	08.81 » 88	444807G	444807	FU	354808G	354808	SR
<b>5- E28</b>							
524d - 524td Except <b>M-Tech</b>	83 » 88	444807G	444807	FU	354808G	354808	SR
525e - 525i Except <b>M-Tech</b>	08.81 » 88	444807G	444807	FU	354808G	354808	SR
528e - 528i Except <b>M-Tech</b>	08.81 » 88	444807G	444807	FU	354808G	354808	SR
<b>BMW 5 SERIES : E34 Berline / Saloon: 88 &gt; 09.92</b>							
<b>5 - E34</b>							
  <sup>(4)</sup> 518i - 520i Except  <b>M-Tech</b>	88 » 07.90	<sup>(5)</sup> 445109G	<sup>(5)</sup> 445109	FU	<sup>(1)</sup> 355213G	<sup>(1)</sup> 355213	SR
  <sup>(4)</sup> 518i - 520i Except  <b>M-Tech</b>	08.90 » 11.95	<sup>(5)</sup> 445211G	<sup>(5)</sup> 445211	FU	<sup>(1)</sup> 355213G	<sup>(1)</sup> 355213	SR
<b>5- E34</b>							
  <sup>(4)</sup> 518i - 520i  524td - 525i - 530i - 535i Except <b>M-Tech</b>	88 » 07.90	<sup>(5)</sup> 445100G	<sup>(5)</sup> 445100	FU	<sup>(1)</sup> 355213G	<sup>(1)</sup> 355213	SR
  <sup>(4)</sup> 518i - 520i  524td - 525i - 525tds, 530i - 535i - 540i Except <b>M-Tech</b>	08.90 » 09.92	<sup>(5)</sup> 445212G	<sup>(5)</sup> 445212	FU	<sup>(1)</sup> 355213G	<sup>(1)</sup> 355213	SR



















MODELE MODEL	ANNEE / YEAR						
		AVANT / FRONT			ARRIÈRE / REAR		
		GAZ / GAS	HYD	TYPE	GAZ / GAS	HYD	TYPE
<b>BMW 5 SERIES : E34 Berline / Saloon: 10.92 &gt; 11.95</b>							
<b>5- E34</b>							
  518i - 520i (SS) 524td - 525i - 525td - 525tds Except <b>M-Tech</b>	(4) 10.92 » 11.95	(5) 445211G	(5) 445211	FU	(1) 355213G	(1) 355213	SR
  530i - 535i - 540i Except <b>M-Tech</b>	(4) 10.92 » 11.95	(5) 445212G	(5) 445212	FU	(1) 355213G	(1) 355213	SR
<b>BMW 5 SERIES : E34 Break/Estate / Touring</b>							
<b>5- E34</b>							
  518g - 518i - 520i - 525td Except (SS) Except <b>M-Tech</b>	(4) 91 » 02.97	(5) 445211G	(5) 445211	FU	(1) 355213G	(1) 355213	SR
  520i - 525 td 525i - 525tds (SS) Except <b>M-Tech</b>	(4) 91 » 02.97	(5) 445212G	(5) 445212	FU	(1) 355213G	(1) 355213	SR
  530i - 535i - 540i Except <b>M-Tech</b>	(4) 91 » 02.97	(5) 445212G	(5) 445212	FU	(1) 355213G	(1) 355213	SR
<b>BMW 6 SERIES</b>							
<b>6 - E24</b>							
630CS - 630CSi - 633CSi Except <b>M-Tech</b>	76 » 82	(3) 444760G	(3) 444760	FU	354771G	354771	SR
628CSi - 635CSi Except <b>M-Tech</b> (SS) → 8170000	78 » 05.82	(3) 444760G	(3) 444760	FU	354771G	354771	SR
628CSi - 635CSi Except <b>M-Tech</b> (SS) 8170001 →	06.82 » 90	(3) 444760G	(3) 444760	FU	(1) 354808G	(1) 354808	SR
<b>BMW 7 SERIES , 8 SERIES</b>							
<b>7 - E23</b>							
728 - 728i - 730 - 733i (SS) → 3035000	77 » 08.79	(3) 444760G	(3) 444760	FU			
728i - 732i - 733i - 735i (SS) 3035001 →	09.79 » 09.81	(3) 444760G	(3) 444760	FU			
725i - 728i - 732i - 735i	10.81 » 86	(3) 444760G	(3) 444760	FU			











MODELE MODEL	ANNEE / YEAR						
		AVANT / FRONT			ARRIÈRE / REAR		
		GAZ / GAS	HYD	TYPE	GAZ / GAS	HYD	TYPE
<b>7 - E23</b>							
745i	79 » 08.86	444760G <sup>(3)</sup>	444760 <sup>(3)</sup>	FU			
<b>BMW 700</b>							
<b>700</b>							
L, C, LS, LSC, CS 	54 » 63		341417	SR		151418	GC
<b>BMW 1502 --&gt; 2202</b>							
<b>1502</b>							
1502	75 » 77		441841	FU		151685	SC
<b>1600</b>							
1600.2 - 1600.2 Ti (Jubilé)	66 » 77		441841	FU		151685	SC
1600 Ti - 1600 Touring - 1602	66 » 78		441841	FU		151685	SC
<b>1800</b>							
1800 - 1800.1 - 1800Ti  1272611 →	66 » 73		441797	FU		251075	GC
1800 <b>A</b>  996251 →	66 » 73		441797	FU		251075	GC
1800 Touring - 1802	66 » 75		441841	FU		151685	SC
<b>2000</b>							
2000 - 2000Ti	66 » 73		441797	FU		251075	GC
2000 CA 2000 CS 	66 » 72		441797	FU		251075	GC
2000 Tilux	69 » 72		441797	FU		251075	GC
2000 Touring (Tii inclus.) - 2002	66 » 75		441841	FU		151685	SC
<b>2202</b>							
2202 Ti - 2202 Tii Touring	68 » 75		441841	FU		151685	SC
<b>BMW 2500 --&gt; 3300</b>							
<b>2500</b>							
Normal 	69 » 08.73	444760G	444760 <sup>(3)</sup>	FU		351086 <sup>(1)</sup>	SR
(E3)  → 2072399	09.73 » 08.75	444760G	444760 <sup>(3)</sup>	FU		351086 <sup>(1)</sup>	SR
(E3)  2072400 →	09.75 »	444760G	444760 <sup>(3)</sup>	FU	354448G	354448	SR
<b>2500 &amp; 2800 &amp; 3.0 S</b>							
Nivomat 	72 » 79	444760G	444760 <sup>(3)</sup>	FU			
<b>2500 A</b>							
(E3)  → 2453395	09.73 » 08.75	444760G	444760 <sup>(3)</sup>	FU		351086 <sup>(1)</sup>	SR







MODELE MODEL	ANNEE / YEAR						
		AVANT / FRONT			ARRIÈRE / REAR		
		GAZ / GAS	HYD	TYPE	GAZ / GAS	HYD	TYPE
<b>2500 A</b>							
(E3)  2453396 →	09.75 »	444760G	444760 <sup>(3)</sup>	FU	354448G	354448	SR
<b>2.8 i, 2.8 L</b>							
(E3)  → 3032934	09.73 » 08.75	444760G	444760 <sup>(3)</sup>	FU		351086 <sup>(1)</sup>	SR
<b>2.8 LA</b>							
(E3)  → 3041377	09.73 » 08.75	444760G	444760 <sup>(3)</sup>	FU		351086 <sup>(1)</sup>	SR
(E3)  3041378 →	09.75 »	444760G	444760 <sup>(3)</sup>	FU	354448G	354448	SR
<b>3.0 L</b>							
(E3)  → 3052296	09.73 » 08.75	444760G	444760 <sup>(3)</sup>	FU		351086 <sup>(1)</sup>	SR
(E3)  3052297 →	09.75 »	444760G	444760 <sup>(3)</sup>	FU	354448G	354448	SR
<b>3.0 LA</b>							
(E3)  → 3061614	09.73 » 08.75	444760G	444760 <sup>(3)</sup>	FU		351086 <sup>(1)</sup>	SR
(E3)  3061615 →	09.75 »	444760G	444760 <sup>(3)</sup>	FU	354448G	354448	SR
<b>3.0 S</b>							
(E3)  → 3025744	09.73 » 08.75	444760G	444760 <sup>(3)</sup>	FU		351086 <sup>(1)</sup>	SR
(E3)  3025745 →	09.75 »	444760G	444760 <sup>(3)</sup>	FU	354448G	354448	SR
<b>3.0 SA</b>							
(E3)  → 2113970	09.73 » 08.75	444760G	444760 <sup>(3)</sup>	FU		351086 <sup>(1)</sup>	SR
(E3)  2113971 →	09.75 »	444760G	444760 <sup>(3)</sup>	FU	354448G	354448	SR
<b>3.0 Si</b>							
(E3)  → 3225208	09.73 » 08.75	444760G	444760 <sup>(3)</sup>	FU		351086 <sup>(1)</sup>	SR
(E3)  3225209 →	09.75 »	444760G	444760 <sup>(3)</sup>	FU	354448G	354448	SR
<b>3.0 SiA</b>							
(E3)  → 3230469	09.73 » 08.75	444760G	444760 <sup>(3)</sup>	FU		351086 <sup>(1)</sup>	SR







MODELE MODEL	ANNEE / YEAR						
		AVANT / FRONT			ARRIÈRE / REAR		
		GAZ / GAS	HYD	TYPE	GAZ / GAS	HYD	TYPE
<b>3.0 SiA</b>							
(E3)  3230470 →	09.75 »	444760G	444760 <sup>(3)</sup>	FU	354448G	354448	SR
<b>3.3 L - 3.3 Li</b>							
(E3)  → 3082410	09.73 » 08.75	444760G	444760 <sup>(3)</sup>	FU		351086 <sup>(1)</sup>	SR
(E3),  3082411 →	09.75 »	444760G	444760 <sup>(3)</sup>	FU	354448G	354448	SR
<b>3.3 LA</b>							
(E3)  → 3090588	09.73 » 08.75	444760G	444760 <sup>(3)</sup>	FU		351086 <sup>(1)</sup>	SR
(E3)  3090589 →	09.75 »	444760G	444760 <sup>(3)</sup>	FU	354448G	354448	SR
<b>2.8 i - 2.8 L</b>							
(E3)  3032935 →	09.75 »	444760G	444760 <sup>(3)</sup>	FU	354448G	354448	SR
<b>2.5 CS</b>							
(E9)	74 »	444760G	444760 <sup>(3)</sup>	FU		254151	GC
<b>2800</b>							
(E9)  CS inclus	68 »	444760G	444760 <sup>(3)</sup>	FU		254151	GC
<b>3.0 CS &amp; CSi</b>							
(E9)	71 »	444760G	444760 <sup>(3)</sup>	FU		254151	GC

## CHEVROLET EUROPE





<b>AVEO</b>							
(T200,T250) 	05 » 02.11	545847G L 545848G R	545847 L 545848 R	JF	155849G	155849	SC
<b>CRUZE</b>							
(J300)  Except 2.0T OPC/VXR	09 »	545864G L 545865G R	545864 L 545865 R	JF	155866G	155866	SC
(J305)  Except 2.0T OPC/VXR	11 »	545864G L 545865G R	545864 L 545865 R	JF	155866G	155866	SC
<b>KALOS</b>							
(KLAS) Daewoo 	02 » 12.04	545864G L 545865G R	545864 L 545865 R	JF	155849G	155849	SC
(T200,T250) 	01.05 »	545847G L 545848G R	545847 L 545848 R	JF	155849G	155849	SC





MODELE MODEL	ANNEE / YEAR						
		AVANT / FRONT			ARRIÈRE / REAR		
		GAZ / GAS	HYD	TYPE	GAZ / GAS	HYD	TYPE
<b>LACETTI - OPTRA</b>							
1.4 16V - 1.6 - 1.9	03.05 »	545016G L 545017G R	545016 L 545017 R	JF	555018G L 555019G R	555018 L 555019 R	JF

## CHRYSLER















### CHRYSLER Espagne / SPAIN

<b>150</b>							
GLS , Confort - S , GT	77 »	144345G	144345	SC	154346G	154346	SC
<b>180</b>							
2 litres Diesel	75 »		441973	FU		251974	GC
<b>900 - 1000 - 1000 E</b>							
900 - 1000 - 1000 E	66 »		141156	SC		171150	SC
<b>1200</b>							
1200	69 »		141721	SC		151722	SC
<b>DODGE DART &amp; GT 3700</b>							
DODGE DART, GT 3700	65 »		141425	SC		111426	SC
<b>HORIZON</b>							
	80 »	144548G	144548	SC	154346G	154346	SC
<b>SAMBA</b>							
 Except Samba Rallye	82 »	544819G	544819	JF	354580G	354580	SR
<b>SOLARA</b>							
	81 »	144345G	144345	SC	154346G	154346	SC
<b>CHRYSLER U.K</b>							
<b>ALPINE</b>							
1.3, 1.4	76 » 80	144345G	144345	SC	154346G	154346	SC
<b>AVENGER</b>							
1300, 1600	76 » 81	444685G	444685	FU	154686G	154686	SC
<b>HUNTER</b>							
1.5, 1.7	77 » 80		441998	FU		151999	SC
<b>SUNBEAM</b>							
0.9, 1.3, 1.6	77 » 82	444685G	444685	FU	154686G	154686	SC
<b>CHRYSLER U.S.A</b>							
<b>VOYAGER 1</b>							
 GRAND VOYAGER, CARAVAN inclus	83 » 12.85				215298G	215298	GC
 GRAND VOYAGER, CARAVAN	01.86 » 01.95	545297G <sup>(2)</sup>	545297 <sup>(2)</sup>	JF	215298G	215298	GC































MODELE MODEL	ANNEE / YEAR						
		AVANT / FRONT			ARRIÈRE / REAR		
		GAZ / GAS	HYD	TYPE	GAZ / GAS	HYD	TYPE
<b>VOYAGER 2</b>							
 GRAND VOYAGER, CARAVAN inclus	02.95 » 02.01				215375G <sup>(1)</sup>	215375 <sup>(1)</sup>	GC















## CITROËN

<b>CITROËN 2 CV - DYANE - MEHARI</b>							
<b>2 CV</b>							
 2 CV 4, 2 CV 6	65 » 08.74				211501G	211501	GC
 AK 250, AZU 250	65 » 08.74				211501G	211501	GC
 AK 250, AZU 250	09.74 »	201545G	201545	GC	211501G	211501	GC
 AZU 250 GA	72 »	201545G	201545	GC	211501G	211501	GC
 AK 350	63 » 68	201545G	201545	GC	201545G	201545	GC
F.A.F	78 »	204478G	204478	GC	204478G	204478	GC
<b>2CV</b>							
 2 CV 4, 2 CV 6	09.74 »	201545G	201545	GC	211501G	211501	GC
 AKS 400	70 » 06.76	201545G	201545	GC	201545G	201545	GC
 AKS 400	07.76 »	204478G	204478	GC	204478G	204478	GC
<b>DYANE</b>							
 Dyane 4 - Dyane 6	67 » 08.74				211501G	211501	GC
 Dyane 4 - Dyane 6	09.74 »	201545G	201545	GC	211501G	211501	GC
<b>ACADIANE</b>							
	78 »	204478G	204478	GC	214636G	214636	GC
<b>DYANE MEHARI - 3 CV</b>							
DYANE MEHARI Piste - 3 CV Azam 6	65 »	201545G	201545	GC	211501G	211501	GC
<b>MEHARI</b>							
	67 » 08.74				211501G	211501	GC
	09.74 »	201545G	201545	GC	211501G	211501	GC
	78 »	204478G	204478	GC	204478G	204478	GC















MODELE MODEL	ANNEE / YEAR						
		AVANT / FRONT			ARRIÈRE / REAR		
		GAZ / GAS	HYD	TYPE	GAZ / GAS	HYD	TYPE
<b>CITROEN AMI</b>							
<b>Ami 6</b>							
	61 » 69	201545G	201545	GC	201545G	201545	GC
	64 » 69	201545G	201545	GC	204478G	204478	GC
<b>Ami 8</b>							
Berline/Saloon 	69 »	201545G	201545	GC	204478G	204478	GC
<b>Ami 8 Super</b>							
Berline/Saloon 	12.72 »	204478G	204478	GC	204478G	204478	GC
<b>CITROËN AX</b>							
<b>AX</b>							
 Except TRS, GT, GTi - AX 	86 »	445159G <sup>(1)</sup>	445159 <sup>(1)</sup>	FU	114972G	114972	SC
 TRS - GT	86 »	445159G <sup>(1)</sup>	445159 <sup>(1)</sup>	FU	214015G	214015	GC
<b>CITROËN BERLINGO I (4x2): 96 &gt; 03.08</b>							
<b>Berlingo</b>							
 <sup>(2)</sup>  Van/Tôle 	96 » 03.08	545280G L 545291G R	545280 L 545291 R	JF	215292G	215292	GC
 <sup>(2)</sup>  Van/Tôle 	96 » 03.08	545293G L 545294G R	545293 L 545294 R	JF	215292G	215292	GC
<b>CITROËN BERLINGO I FIRST (4x2): 04.08 &gt; EXCEPT BERLINGO II</b>							
<b>Berlingo 1 FIRST</b>							
 <sup>(2)</sup>  Van/Tôle 	04.08 »	545280G L 545291G R	545280 L 545291 R	JF	215292G	215292	GC
 <sup>(2)</sup>  Van/Tôle 	04.08 »	545293G L 545294G R	545293 L 545294 R	JF	215292G	215292	GC
<b>CITROËN BERLINGO II (4x2): 04.08 &gt; EXCEPT BERLINGO I FIRST</b>							
<b>Berlingo 2</b>							
 Van/Tôle 	04.08 »	545810G L 545821G R	545810 L 545821 R	JF	215872G	215872	GC
  	04.08 »	545810G L 545821G R	545810 L 545821 R	JF	215871G	215871	GC
<b>CITROËN C1</b>							
<b>C1</b>							
 	05 » 01.12	545696G L 545697G R	545696 L 545697 R	JF	155698G	155698	SC



















MODELE MODEL	ANNEE / YEAR						
		AVANT / FRONT			ARRIÈRE / REAR		
		GAZ / GAS	HYD	TYPE	GAZ / GAS	HYD	TYPE
<b>C1 II</b>							
	03.14 »				155698G	155698	SC
<b>CITROËN C2</b>							
<b>C2</b>							
(J)  VTR, VTS inclus Except 	03 »	545580G L 545591G R	545580 L 545591 R	JF	115592G	115592	SC
(J) 	03 »	545719G L 545710G R	545719 L 545710 R	JF			
<b>CITROËN C3 Phase 1, Except Classic, Picasso</b>							
<b>C3 Phase 1</b>							
(F) 1.1i, 1.4i, 1.4HDi, 1.6i, 1.6HDi. Except 1.6i 110 <b>A</b> , 1.6HDi 110 Except VTR, X-TR, Pluriel, Picasso Except  Except 	02 » 09.09	545580G L 545591G R	545580 L 545591 R	JF	115592G	115592	SC
(F) 1.6i 110 <b>A</b> → N°OPR 10800, 1.6HDi 110 → N°OPR 10800 Except Pluriel, Picasso Except 	02 » 09.09				115592G	115592	SC
(F) 1.6i 110 <b>A</b> N°OPR 10801 → 1.6HDi 110 : N°OPR 10801 → Except Pluriel, Picasso Except 	02 » 09.09	545580G L 545591G R	545580 L 545591 R	JF	115592G	115592	SC
(F)  (+)   Entreprise inclus	03 » 10.09	545719G L 545710G R	545719 L 545710 R	JF	115592G	115592	SC
(H) PLURIEL 	03 »	545719G L 545710G R	545719 L 545710 R	JF	115592G	115592	SC
<b>CITROËN C3 Classic Phase 1, Except C3 Phase 2, Picasso</b>							
<b>C3</b>							
CLASSIC 1.1i, 1.4HDi Except Phase 2	10.09 »	545580G L 545591G R	545580 L 545591 R	JF	115592G	115592	SC

































MODELE MODEL	ANNEE / YEAR						
		AVANT / FRONT			ARRIÈRE / REAR		
		GAZ / GAS	HYD	TYPE	GAZ / GAS	HYD	TYPE
<b>CITROËN C3 Phase 2, Except Picasso</b>							
<b>C3 Phase 2</b>							
 Except Classic phase 1 Ø Intérieur pivot/Hub internal Ø = 47 mm ou/or Ø Intérieur pivot/Hub internal Ø = 51 mm	10.09 »	(3) 545784G L 545785G R ou/or 545703G L 545704G R	(3) 545784 L 545785 R ou/or 545703 L 545704 R	JF	115792G	115792	SC
<b>CITROËN C3 PICASSO</b>							
<b>C3 PICASSO</b>							
 Except XTR	08 » 09.12	545774G L 545775G R	545774 L 545775 R	JF	215776G	215776	GC
<b>CITROËN C4</b>							
<b>C4 (LC)</b>							
(LC)  Except Picasso Except 	04 » 08.10	545594G L 545595G R	545594 L 545595 R	JF	255596G	255596	GC
(LC)  Except Picasso	04 » 08.10	545508G L 545509G R	545508 L 545509 R	JF	255615G	255615	GC
<b>C4 (LA)</b>							
(LA)  Except VTS, WRC, Picasso Except 	04 » 08.10	545594G L 545595G R	545594 L 545595 R	JF	255596G	255596	GC
<b>C4 (B7)</b>							
(B7)  Except THP	09.10 »	545837G L 545838G R	545837 L 545838 R	JF	255839G	255839	GC
<b>C4 CACTUS</b>							
	14 »	545953G L 545954G R	545953 L 545954 R	JF	115955G	115955	SC
<b>CITROËN C4 PICASSO</b>							
<b>C4 PICASSO</b>							
(UD)  5 Places/Seats	07 » 02.13	545810G L 545821G R	545810 L 545821 R	JF	(4) 215860G	(4) 215860	GC



MODELE MODEL	ANNEE / YEAR						
		AVANT / FRONT			ARRIÈRE / REAR		
		GAZ / GAS	HYD	TYPE	GAZ / GAS	HYD	TYPE
<b>C4 PICASSO</b>							
(UA)  7 Places/Seats GRAND PICASSO	06 » 08.13	545810G L 545821G R	545810 L 545821 R	JF	<sup>(4)</sup> 215871G	<sup>(4)</sup> 215871	GC
<b>C4 PICASSO II</b>							
(B78)  5 Places/Seats	03.13 »				<sup>(4)</sup> 755049G	<sup>(4)</sup> 755049	PLL
(B78)  7 Places/Seats GRAND PICASSO	09.13 »				<sup>(4)</sup> 755040G	<sup>(4)</sup> 755040	PLL
<b>CITROËN C5</b>							
<b>C5</b>							
(RD, TD)  Suspension Métallique Except Suspension Hydractive	08 »	345679G	345679	SR	355670G	355670	SR
<b>CITROËN C8</b>							
<b>C8</b>							
(EA, EB) 	02 »	545676G L 545677G R	545676 L 545677 R	JF	215678G	215678	GC
<b>CITROËN C15</b>							
<b>C 15 E</b>							
 <sup>(2)</sup> Essence/Petrol   → N PR 4195	84 » 07.87	544819G	544819	JF	355111G	355111	SR
 <sup>(2)</sup> Essence/Petrol   N PR 4196 →	08.87 »	544941G	544941	JF	355111G	355111	SR
 <sup>(2)</sup> Essence/Petrol 	87 »	545155G	545155	JF	355111G	355111	SR
<b>C 15 D</b>							
 <sup>(2)</sup> Diesel 	85 »	544941G	544941	JF	355111G	355111	SR































MODELE MODEL	ANNEE / YEAR						
		AVANT / FRONT			ARRIÈRE / REAR		
		GAZ / GAS	HYD	TYPE	GAZ / GAS	HYD	TYPE
<b>C 15 D</b>							
 (2) Diesel 	85 »	545155G	545155	JF	355111G	355111	SR
<b>CITROËN C25 --&gt; C35</b>							
<b>C 25</b>							
(280, 290)   Except 	81 » 12.85	544960G	544960	JF	214809G	214809	GC
(280, 290)  	81 » 12.85	544960G	544960	JF	214963G	214963	GC
(280, 290) (2)   Except  	01.86 » 94	544040G	544040	JF	214809G (5)	214809 (5)	GC
(280, 290) (2)   Except 	01.86 » 94	544961G	544961	JF	714968G (5)	714968 (5)	PLL
(280, 290) (2)   Except 	01.86 » 94	544040G	544040	JF	214963G (5)	214963 (5)	GC
(280, 290) (2)   	01.86 » 94	544961G	544961	JF			
<b>C 32 &amp; C 35</b>							
(280, 290)  	73 »	204364G	204364	GC	214365G	214365	GC
<b>CITROËN C-ELYSEE</b>							
<b>C-ELYSEE</b>							
 Ø Intérieur Pivot/Hup internal Ø = 47 mm	12 »	545912G L 545913G R	545912 L 545913 R	JF	115916G	115916	SC
<b>CITROËN DS3</b>							
<b>DS3</b>							
  Except  , 1.6 THP 203, Racing	09 » 05.14	545784G L (3) 545785G R ou/or 545703G L 545704G R	545784 L (3) 545785 R ou/or 545703 L 545704 R	JF	215819G	215819	GC
<b>CITROËN DS4</b>							
<b>DS4</b>							
 Except R, Racing, 	10 »	545837G L 545838G R	545837 L 545838 R	JF	255839G	255839	GC















MODELE MODEL	ANNEE / YEAR						
		AVANT / FRONT			ARRIÈRE / REAR		
		GAZ / GAS	HYD	TYPE	GAZ / GAS	HYD	TYPE
<b>DS5</b>							
 Expect <b>SPORT</b>	11 » 04.15				254831G	254831	GC
<b>CITROËN EVASION, SYNERGIE</b>							
<b>EVASION &amp; SYNERGIE</b>							
(22, U6)  (  → 7609)	94 » 08.97	545284G	545284	JF	<sup>(6)</sup> 215245G	<sup>(6)</sup> 215245	GC
(22, U6)  (  7610 →)	09.97 »	545284G	545284	JF	<sup>(6)</sup> 215468G	<sup>(6)</sup> 215468	GC
<b>CITROËN H</b>							
<b>TYPE H</b>							
 4 Amortisseurs AV/4 Front shocks 2 courts/short: int	» 69	101511G	101511	SC	211513G	211513	GC
 4 Amortisseurs AV/4 Front shocks 2 longs/long: ext	» 69	101512G	101512	SC	211513G	211513	GC
<b>TYPE HY &amp; HZ</b>							
 1000 → 1600	70 »	201896G	201896	GC	211897G	211897	GC
<b>180 K</b>							
	70 »				211981G	211981	GC
<b>CITROËN JUMPER &amp; RELAY</b>							
<b>JUMPER &amp; RELAY</b>							
(230, 240)   (2.7t)  (3.1t, 3.3t)	<sup>(2)</sup> 94 » 05.06	545263G	545263	JF	<sup>(5)</sup> 215243G	<sup>(5)</sup> 215243	GC
(230, 240)   (35=3.5t)	<sup>(2)</sup> 94 » 05.06	545505G	545505	JF	<sup>(5)</sup> 715244G	<sup>(5)</sup> 715244	PLL
(230, 240)  	<sup>(2)</sup> 94 » 05.06	545263G	545263	JF	<sup>(5)</sup> 215243G	<sup>(5)</sup> 215243	GC
30, 33, 35   Except 	<sup>(2)</sup> 06.06 » 05.11	545828G	545828	JF	<sup>(5) (7)</sup> 715861G	<sup>(5) (7)</sup> 715861	PLL















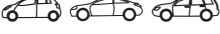

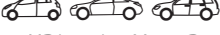
MODELE MODEL	ANNEE / YEAR						
		AVANT / FRONT			ARRIÈRE / REAR		
		GAZ / GAS	HYD	TYPE	GAZ / GAS	HYD	TYPE
<b>JUMPER &amp; RELAY</b>							
30, 33, 35  Except 	(2) 06.06 » 05.11	545828G	545828	JF	<sup>(5) (7)</sup> 715872G	<sup>(5) (7)</sup> 715872	PLL
30, 33, 35  Except 	(2) 06.06 » 05.11	545828G	545828	JF	<sup>(5) (7)</sup> 715873G	<sup>(5) (7)</sup> 715873	PLL
30, 33, 35   Except 	(2) 06.06 » 05.11	545830G	545830	JF	<sup>(5) (7)</sup> 715861G 715872G 715873G	<sup>(5) (7)</sup> 715861 715872 715873	PLL
<b>CITROËN JUMPY &amp; DISPATCH</b>							
<b>JUMPY &amp; DISPATCH</b>							
 :  → 7609	95 » 07.97	545289G	545289	JF	215296G	215296	GC
 :  7610 → 9792	08.97 » 12.03	545289G	545289	JF	215475G	215475	GC
  9793 →	01.04 » 06.06				215475G	215475	GC
 Chassi Cabine Except  Except 	07.06 »	545804G L 545805G R	545804 L 545805 R	JF	215840G	215840	GC
 (+)  	07.06 »	545804G L 545805G R	545804 L 545805 R	JF	215851G	215851	GC
 ATLANTE Except  Except 	07.06 »	545804G L 545805G R	545804 L 545805 R	JF	215840G	215840	GC
 ATLANTE 	07.06 »	545804G L 545805G R	545804 L 545805 R	JF	215851G	215851	GC
<b>CITROËN LN - LNA</b>							
<b>LN</b>							
3 CV, 602 cc	76 » 04.77	444193G <sup>(10)</sup>	444193 <sup>(10)</sup>	FU		354883 <sup>(9)</sup>	SR
3 CV16, 602 cc	05.77 » 10.78	444193G <sup>(10)</sup>	444193 <sup>(10)</sup>	FU	354711G <sup>(9)</sup>	354711 <sup>(9)</sup>	SR
<b>LNA</b>							
4, 5 CV, 652 cc, 1124 cc	11.78 » 86	544819G	544819	JF	354711G <sup>(9)</sup>	354711 <sup>(9)</sup>	SR
<b>CITROËN NEMO</b>							
<b>NEMO</b>							
	07 »	545603G L 545604G R	545603 L 545604 R	JF	115752G	115752	SC
<b>NEMO COMBI</b>							
	08 »	545603G L 545604G R	545603 L 545604 R	JF	115752G	115752	SC





MODELE MODEL	ANNEE / YEAR						
		AVANT / FRONT			ARRIÈRE / REAR		
		GAZ / GAS	HYD	TYPE	GAZ / GAS	HYD	TYPE
<b>CITROËN SAXO 1 &amp; 2</b>							
<b>SAXO</b>							
 954 cc, 1124 cc Except Entreprise	96 »	445159G	445159	FU	215162G	215162	SC
 954 cc, 1124 cc Entreprise/Commerciale	96 »	445159G	445159	FU	215162G	215162	GC
 1360 cc, 1587 cc Except 1.4i VTS, 1.6i, 1.6i 16V/VTR/VTS	96 »	445159G	445159	FU	215162G	215162	GC
 1527 cc 1.5D Entreprise inclus	96 »	445159G	445159	FU	215162G	215162	GC
 1.4i VTS, 1.6i, 16V,VTR, VTS inclus	96 »	445159G	445159	FU	215162G	215162	GC
<b>CITROËN TRACTION</b>							
<b>TRACTION</b>							
AV - 11 CV	35 » 56	101151G	101151	SC	111152G	111152	SC
AV - 15 CV	39 » 56	101153G	101153	SC	111152G	111152	SC
<b>CITROËN VISA</b>							
<b>VISA</b>							
4, 5 CV 	78 » 84	544819G	544819	JF	354627G <sup>(9)</sup>	354627 <sup>(9)</sup>	SR
Challenger, Chrono, GT	82 » 91	544819G	544819	JF	354580G <sup>(9)</sup>	354580 <sup>(9)</sup>	SR
GTi	85 » 91	544948G L 544949G R	544948 L 544949 R	JF	354580G <sup>(9)</sup>	354580 <sup>(9)</sup>	SR
<b>VISA II</b>							
 Except Challenger, Chrono, Diesel, GT, GTi	84 » 91	544819G	544819	JF	354627G <sup>(9)</sup>	354627 <sup>(9)</sup>	SR
Diesel, 17 D, 17 RD	84 » 91	544941G	544941	JF	354627G <sup>(9)</sup>	354627 <sup>(9)</sup>	SR
<b>CITROËN XSARA I EXCEPT PICASSO</b>							
<b>XSARA 1</b>							
 1.4, 1.5D, 1.6 Except Picasso	97 » 08.00	545280G L 545291G R	545280 L 545291 R	JF	114942G	114942	SC
 1.8 Except D, VTS, Picasso	97 » 08.00	545280G L 545291G R	545280 L 545291 R	JF	214940G	214940	GC







MODELE MODEL	ANNEE / YEAR						
		AVANT / FRONT			ARRIÈRE / REAR		
		GAZ / GAS	HYD	TYPE	GAZ / GAS	HYD	TYPE
<b>XSARA 1</b>							
 1.8D, 1.8 VTS Except Picasso	97 » 08.00	545293G L 545294G R	545293 L 545294 R	JF	214940G	214940	GC
 1.9 D Except Picasso 1.9 TD, Except VTS, Picasso	97 » 08.00	545280G L 545291G R	545280 L 545291 R	JF	214940G	214940	GC
 1.9 TD VTS Except Picasso 2.0 VTS Inclus, 2.0 Hdi VTS Inclus Except Picasso	97 » 08.00	545293G L 545294G R	545293 L 545294 R	JF	214940G	214940	GC
<b>CITROËN XSARA II, EXCEPT PICASSO</b>							
<b>XSARA 2</b>							
 1.4i Except Picasso Except 	09.00 »	545506G L 545507G R	545506 L 545507 R	JF	214940G	214940	GC
 1.4Hdi, 1.6i 16V, 1.9 D, 2.0i 16V, 2.0 HDi VTS inclus Except 	09.00 »	545280G L 545291G R	545280 L 545291 R	JF	214940G	214940	GC
  Except Picasso	09.00 »				214940G	214940	GC
<b>CITROËN XSARA PICASSO</b>							
<b>XSARA PICASSO</b>							
(N68) 	98 » 06	545542G L 545543G R	545542 L 545543 R	JF	215544G	215544	GC
<b>CITROËN ZX Berline/Saloon Essence / Petrol</b>							
<b>ZX</b>							
 <sup>(11)</sup> Essence/Petrol 1124 cc, 1360 cc → N° OPR 5683	91 » 03.92	<sup>(12)</sup> 545163G L 545164G R	<sup>(12)</sup> 545163 L 545164 R	JF	114942G	114942	SC
 <sup>(11)</sup> Essence/Petrol 1580 cc, 1761 cc → N° OPR 5683	91 » 03.92	<sup>(12)</sup> 545163G L 545164G R	<sup>(12)</sup> 545163 L 545164 R	JF	114942G	114942	SC
 <sup>(11)</sup> Essence/Petrol 1905 cc, 1998 cc Except 16V → N° OPR 5683	91 » 03.92	545174G L 545175 R	545174 L 545175 R	JF	214940G	214940	GC





MODELE MODEL	ANNEE / YEAR						
		AVANT / FRONT			ARRIÈRE / REAR		
		GAZ / GAS	HYD	TYPE	GAZ / GAS	HYD	TYPE

**ZX**

 (11) Esence/Petrol 1124 cc, 1360 cc N° OPR 5684 →	04.92 » 98	(12) 545163G L 545164G R	(12) 545163 L 545164 R	JF	114942G	114942	SC
 (11) Esence/Petrol 1580 cc, 1761 cc N° OPR 5684 →	04.92 » 98	545163G L 545164G R	545163 L 545164 R	JF	114942G	114942	SC
 (11) Esence/Petrol 1905 cc - 1998 cc Except 16V N° OPR 5684 →	04.92 » 98	545163G L 545164G R	545163 L 545164 R	JF	214940G	214940	GC
 (11) Esence/Petrol 1998 cc 16V	92 » 98	545293G L 545294G R	545293 L 545294 R	JF	214940G	214940	GC

**CITROËN ZX Berline/Saloon Diesel**

**ZX Berline/Saloon Diesel**

 (11) Diesel 1905 cc → N° PR 5683	91 » 03.92	(12) 545163G L 545164G R	(12) 545163 L 545164 R	JF	214940G	214940	GC
 (11) 1769 cc, 1905 cc Diesel, ABS, Turbo Diesel N° PR 5684 →	04.92 » 98	545163G L 545164G R	545163 L 545164 R	JF	214940G	214940	GC

**CITROËN ZX Break / Estate**

**ZX**

 92 » 98	545163G L 545164G R	545163 L 545164 R	JF	214940G	214940	GC
---	------------------------	----------------------	----	---------	--------	----

**COURNIL**

**COURNIL**













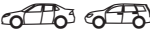











 Tracteur Tous Terrains	101508G	101508	SC	101508G	101508	SC
--	---------	--------	----	---------	--------	----

**DACIA**

















**1100**

(Base/Basis) (R8, R10) 1132, 1133	67 »	141114G	141114	SC	151743G	151743	SC
--------------------------------------	------	---------	--------	----	---------	--------	----





MODELE MODEL	ANNEE / YEAR						
		AVANT / FRONT			ARRIÈRE / REAR		
		GAZ / GAS	HYD	TYPE	GAZ / GAS	HYD	TYPE
<b>1300</b>							
(R12)  1210 - 1310 - 1410	70 »	364188G	364188	SR	174185G	174185	SC
<b>R 18</b>							
	78 »	364501G	364501	SR	174502G	174502	SC
<b>DOKKER</b>							
 Except  Stepway	12 »	545889G	545889	JF	215880G	215880	GC
<b>DOKKER VAN</b>							
	12 »	545889G	545889	JF			
<b>DUSTER</b>							
 Except 	10 »	545813G	545813	JF	155814G	155814	SC
 Except 	10 »	545813G	545813	JF	555815G	555815	JF
<b>LODGY</b>							
 MCV 5/7 Places/Seats	12 »	545887G	545887	JF	215888G	215888	GC
<b>LOGAN 1</b>							
	04 » 10.12	545668G	545668	JF	155669G	155669	SC
 (Hatchback)	08 » 10.12	545668G	545668	JF	155669G	155669	SC
 MCV 5/7 Places/Seats	07 » 06.13	545668G	545668	JF	155773G	155773	SC
	07 »	545668G	545668	JF	155773G	155773	SC
	07 »	545668G	545668	JF	155773G	155773	SC
<b>LOGAN 2</b>							
 (-)  Except garde au sol augmentée	11.12 »	545892G	545892	JF	155893G	155893	SC
 (+)  Except garde au sol augmentée	11.12 »	545891G	545891	JF	155893G	155893	SC
 (-)  (+) Garde au sol augmentée	11.12 »	545878G	545878	JF	155893G	155893	SC
 (+)  (+) Garde au sol augmentée	11.12 »	545908G	545908	JF	155893G	155893	SC









MODELE MODEL	ANNEE / YEAR						
		AVANT / FRONT			ARRIÈRE / REAR		
		GAZ / GAS	HYD	TYPE	GAZ / GAS	HYD	TYPE
<b>LOGAN 2</b>							
 MCV Except garde au sol augmentée	07.13 »	545891G	545891	JF	155893G	155893	SC
 MCV,Cross (+) Garde au sol augmentée	07.13 »	545878G	545878	JF	155669G	155669	SC
<b>SOLENZA</b>							
	02 »	544884G	544884	JF	154922G	154922	SC
<b>SANDERO 1</b>							
 Except Stepway	07 » 08.12	545668G	545668	JF	155669G	155669	SC
<b>SANDERO 1 STEPWAY</b>							
	07 » 08.12	545906G	545906	JF	155907G	155907	SC
<b>SANDERO 2</b>							
 (-)  Except garde au sol augmentée	11.12 »	545892G	545892	JF	155893G	155893	SC
 (+)  Except garde au sol augmentée	11.12 »	545891G	545891	JF	155893G	155893	SC
 (-)  (+) Garde au sol augmentée	11.12 »	545878G	545878	JF	155893G	155893	SC
 (+)  (+) Garde au sol augmentée	11.12 »	545908G	545908	JF	155893G	155893	SC
<b>SANDERO 2 STEPWAY</b>							
	09.12 »	545873G	545873	JF	155874G	155874	SC















## DAEWOO

<b>ARANOS &amp; CIELO &amp; ESPERO</b>							
	92 »	444640G	444640	FU	155149G	155149	SC
<b>KALOS</b>							
(KLAS) 	03 » 12.04	545847G L 545848G R	545847 L 545848 R	JF	155849G	155849	SC
<b>KORANDO</b>							
	99	245112G	245112	GC	255554G	255554	GC











MODELE MODEL	ANNEE / YEAR						
		AVANT / FRONT			ARRIÈRE / REAR		
		GAZ / GAS	HYD	TYPE	GAZ / GAS	HYD	TYPE
<b>LACETTI</b>							
1.4 16V - 1.6 - 1.8	02.04 »	545016G L 545017G R	545016 L 545017 R	JF	555018G L 555019G R	555018 L 555019 R	JF
<b>LANOS &amp; SENS</b>							
	97 »	444640G	444640	FU	155149G	155149	SC
<b>MUSSO</b>							
	93 »	745658G	745658	PLL	255659G	255659	GC
<b>NEXIA</b>							
	94 »	444640G	444640	FU	155149G	155149	SC
<b>NUBIRA 2</b>							
1.6 16V, 2.0 16V	06.99 » 06.03	548681G L 548682G R	548681 L 548682 R	JF	558683G L 558684G R	558683 L 558684 R	JF
<b>RACER</b>							
	94 »	444640G	444640	FU	155149G	155149	SC
<b>REXTON</b>							
(GAB)  2,9 TD, 3,2 V6	04.02 » 05.04	345981G	345981	SR	255983G	255983	GC

## DAF









<b>31</b>							
	61 »		441967	FU		131526	SC
<b>33</b>							
 (  ) → 196372	» 08.67		441967	FU		131526	SC
 (  ) 196373 →	09.67 » 74		441905	FU		131526	SC
<b>44</b>							
 (  ) → 550595	66 » 01.70		441969	FU		151976	SC
 (  ) 550596 →	02.70 » 76		441969	FU		151976	SC
<b>46</b>							
	72 » 76		441971	FU		174393	SC
<b>55</b>							
 (  ) → 545677	68 » 01.70		441971	FU		151976	SC
Marathon inclus  (  ) 545678 →	02.70 » 76		441971	FU		151976	SC











MODELE MODEL	ANNEE / YEAR						
		AVANT / FRONT			ARRIÈRE / REAR		
		GAZ / GAS	HYD	TYPE	GAZ / GAS	HYD	TYPE
<b>66</b>							
	72 » 76		441971	FU		174393	SC
<b>200</b>							
	87 »		105137	SC		215138	GC
	87 »		145146	SC		215138	GC
<b>400</b>							
  	87 »		205151	GC		215152	GC
<b>600</b>							
 31001 →	61 » 63		441967	FU		131526	SC
<b>750</b>							
S, L	63 » 67		441967	FU		131526	SC
<b>1300</b>							
Marathon inclus	72 » 76		441971	FU		174393	SC
<b>DAFFODIL</b>							
DAFFODIL	61 »		441967	FU		131526	SC

## DAIHATSU

<b>CHARMANT</b>							
 A 10, A 20, A 30, A 40	74 » 82		444317	FU		154334	SC
 A 10, A 20, A 30, A 40	74 » 82		444317	FU			
 A 35 (1300), A 55 (1500)	81 » 08.83		444845	FU	154130G	154130	SC
 A 45 (1600)	81 » 08.83		444404	FU	154130G	154130	SC
 A 35 (1300), A60 (1600)	09.83 » 88		444404	FU	154130G	154130	SC
<b>FEROZA &amp; SPORTRACK</b>							
 F300Series Except F310	88 »					145148G	145148
							SC
<b>FOURTRACK &amp; ROCKY &amp; TAFT &amp; WILDACT</b>							
 F10, F20, F50, F60	74 » 84	104534G	104534	SC	114786G	114786	SC
 F25, F55, F65	79 » 84	104534G	104534	SC	234600G	234600	GC
 F70, F75, F80, F85	84 » 04.93	145148G	145148	SC	145148G	145148	SC





MODELE MODEL	ANNEE / YEAR						
		AVANT / FRONT			ARRIÈRE / REAR		
		GAZ / GAS	HYD	TYPE	GAZ / GAS	HYD	TYPE
<b>FOURTRACK &amp; ROCKY &amp; TAFT &amp; WILDACT</b>							
  F77, F87	(1) 84 » 04.93	145148G	145148	SC	234600G	234600	GC
 F73, F78, F98	05.93 »	145208G	145208	SC			
<b>WIDE CAB</b>							
 S70, S75, S76	83 »				104534G	104534	SC



## DAIMLER

<b>2.5 L</b>							
V8	62 » 70		241344	GC		271345	GC
<b>DOUBLE SIX</b>							
4 Amortisseurs AR/4 Rear Shocks	72 » 02.93		141822	SC		311823	SR
<b>SOVEREIGN</b>							
4 Amortisseurs AR/4 Rear Shocks	66 » 68		241756	GC		311757	SR
4 Amortisseurs AR/4 Rear Shocks	69 » 09.86		141822	SC		311823	SR

## DKW

<b>DKW</b>							
 1000, 1000 S, 1000 SP	58 » 06.63		101641	SC		111104	SC
 1000, 1000 S, 1000 SP	07.63 »		101641	SC			
F 102	63 » 66		141587	SC		151588	SC



## EBRO

<b>JEEP BRAVO</b>							
 C J3, C J6			104534	SC		105128	SC
<b>JEEP Commando</b>							
 S, VJ			105128	SC		214880	GC
<b>THAMES TRADER</b>							
						871718	PL













## FACEL VEGA

<b>EXCELLENCE</b>							
	50 » 60		141319	SC		131319	SC
<b>FACEL 3 &amp; FACELLIA</b>							
	60 » 62		141498	SC		131499	SC

























MODELE MODEL	ANNEE / YEAR						
		AVANT / FRONT			ARRIÈRE / REAR		
		GAZ / GAS	HYD	TYPE	GAZ / GAS	HYD	TYPE
<b>F.V.2 , F.V.3</b>							
	» 05.59					131319	SC
<b>HK 500 &amp; PRESIDENCE</b>							
	50 » 60		141319	SC		131319	SC

















## FIAT

FIAT 124 --> 128							
<b>124</b>							
 (F, D) → 466320	66 » 08.68		141628	SC		151629	SC
 (F, D) → 066058	67 » 08.68		141628	SC		151629	SC
 Spider (F, D) → 1759186	67 » 08.68		141628	SC		151629	SC
 (F, D) 466321 →	09.68 » 76		141628	SC		151801	SC
 (F, D) 066059 →	09.68 » 76		141628	SC		151801	SC
 Spider (F, D) 1759187 →	09.68 » 76		141628	SC		151801	SC
S, T, Special, Special T	68 » 76		141628	SC		151801	SC
Sport 1400 - 1600  ,  Spider	68 » 76		141628	SC		151801	SC
D Pamplona	68 » 77		141628	SC		151801	SC
FAMILIARE 	66 » 75		141628	SC		111867	SC
<b>125</b>							
 Spécial S	67 » 72	141601G	141601	SC		151602	SC
<b>126</b>							
 Except 126 Bis	72 »	161350G	161350	SC		171361	SC
<b>127</b>							
 900, 1050, C, L, CL Except Diesel	71 » 84	544825G	544825	JF	554851G	554851	JF
 900, 1050 Special Super Except Diesel	71 » 84	544825G	544825	JF	554851G	554851	JF















MODELE MODEL	ANNEE / YEAR						
		AVANT / FRONT			ARRIÈRE / REAR		
		GAZ / GAS	HYD	TYPE	GAZ / GAS	HYD	TYPE
<b>127</b>							
 Sport 1100, 1300, 127 Rustica Except Diesel	78 » 84	544825G	544825	JF	554851G	554851	JF
 Diesel	82 » 84	544042G	544042	JF			
 PANORAMA	79 » 84	544825G	544825	JF			
<b>128</b>							
  	69 » 81	544813G	544813	JF	554852G	554852	JF
<b>FIAT 131</b>							
<b>131</b>							
 Mirafiori	74 » 02.78		544810	JF		151801	SC
 Mirafiori Familiare	74 » 02.78		544810	JF		114829	SC
 Essence/Petrol, Supermirafiori	03.78 » 02.81		544821	JF		151801	SC
   <b>SPORT</b>	03.78 » 84		544821	JF		151801	SC
 Diesel	78 » 02.81		544811	JF		151801	SC
 Essence/Petrol, Supermirafiori Familiare	03.78 » 02.81		544821	JF		114829	SC
 - Diesel - Panorama	78 » 02.81		544811	JF		114829	SC
 III Series	03.81 » 84					151801	SC
 III Series, Panorama	03.81 » 84					114829	SC
<b>FIAT 132 --&gt; 242</b>							
<b>132</b>							
	72 » 85		141601	SC		154110	SC
<b>133</b>							
	74 » 79		121572	SC		131573	SC
<b>147</b>							
Berline/Saloon :  → 359244	76 »	544042G	544042	JF	554851G	554851	JF
Berline/Saloon :  359245 →	76 »	544042G	544042	JF			











MODELE MODEL	ANNEE / YEAR						
		AVANT / FRONT			ARRIÈRE / REAR		
		GAZ / GAS	HYD	TYPE	GAZ / GAS	HYD	TYPE
<b>238</b>							
 			201800	GC		211911	GC
<b>242</b>							
 	74 »		204364	GC		214365	GC
<b>FIAT 500 --&gt; 1600</b>							
<b>500</b>							
 Gardiniera inclus	57 » 77		161350	SC		171361	SC
 Except Abarth	07 »	545744G L 545745G R	545744 L 545745 R	JF	115746G	115746	SC
<b>500 L</b>							
 Except Living, Trekking, Abarth	12 »	545945G L 545946G R	545945 L 545946 R	JF	155947G	155947	SC
<b>500 C</b>							
 Except Abarth	09 »	545744G L 545945G R	545744 L 545945 R	JF	115746G	115746	SC
<b>600</b>							
600, 600 D  → 1422965	55 » 63		161350	SC		171386	SC
600, 600 D  1422966 →	64 » 71		161544	SC		171386	SC
600 D Multipla, 600 T Micro Car 	56 » 65		141388	SC		171386	SC
600 T (200 B)	66 » 70		141388	SC		171703	SC
<b>850</b>							
 Spider	64 » 73		121572	SC		131573	SC
 Familiare	68 »		141388	SC		171703	SC
850 T (200 BF)	66 » 77		141388	SS		171703	SC
<b>900</b>							
900 E - 900 T	66 »		141388	SC		171703	SC
<b>1100</b>							
1100 R 	66 » 69		141388	SC		151762	SC
1100 R  Familiare	66 » 69		141388	SC		111366	SC
<b>1200</b>							
1200TS Farina , Spider	66 » 69		141388	SC		111366	SC





























MODELE MODEL	ANNEE / YEAR						
		AVANT / FRONT			ARRIÈRE / REAR		
		GAZ / GAS	HYD	TYPE	GAZ / GAS	HYD	TYPE
<b>1300 - 1500</b>							
 (  ) → 299000	61 » 63		141496	SC		111496	SC
 (  ) 299001 →	64 » 68		141496	SC		151762	SC
 Familiare	61 » 68		141496	SC		111496	SC
<b>1500</b>							
Ghia 	64 » 65		141496	SC		111496	SC
1500 GT  Ghia	67 »		141496	SC		111496	SC
<b>1500S - 1600 S</b>							
1500S Farina inclus, 1600 S	60 » 67		141388	SC		111366	SC
<b>FIAT ARGENTA</b>							
<b>ARGENTA</b>							
	81 » 86		141601	SC		151801	SC
<b>FIAT BRAVA &amp; BRAVO I Phase 1</b>							
<b>BRAVA &amp; BRAVO</b>							
(182) 1.4 (  ) → 4085697	95 » 01.96	544058G	544058	JF	114059G	114059	SC
(182) 1.4 (  ) 4085698 →	02.96 » 10,98	545311G	545311	JF	114059G	114059	SC
(182) 1.6	95 » 10.98	545311G	545311	JF	215160G	215160	GC
(182) 1.8	95 » 10.98	545376G	545376	JF	215160G	215160	GC
(182) 1.9 D	95 » 10.98	545311G	545311	JF	215160G	215160	GC
(182) 1.9 TD	95 » 10.98	545376G	545376	JF	215160G	215160	GC
<b>FIAT BRAVA , BRAVO I Phase 2</b>							
<b>BRAVA &amp; BRAVO</b>							
(182) Essence/Petrol, 80 (1242cc)	11.98 » 02	545311G	545311	JF	114059G	114059	SC
(182) Essence/Petrol, 100 (1581cc)	11.98 » 02	545311G	545311	JF	215160G	215160	GC













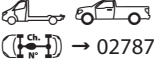
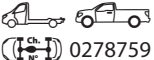
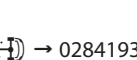

MODELE MODEL	ANNEE / YEAR						
		AVANT / FRONT			ARRIÈRE / REAR		
		GAZ / GAS	HYD	TYPE	GAZ / GAS	HYD	TYPE
<b>BRAVA &amp; BRAVO</b>							
(182) Essence/Petrol, 115 (1747cc)	11.98 » 02	545376G	545376	JF	215160G	215160	GC
(182) Essence/Petrol, 155 (1998cc)	11.98 » 02	545376G	545376	JF	215160G	215160	GC
(182) Diesel, TD 75 (1910cc)	11.98 » 02	545311G	545311	JF	215160G	215160	GC
(182) Diesel, TD 100 (1910cc)	11.98 » 02	545376G	545376	JF	215160G	215160	GC
(182) Diesel, JTD 105 (1910cc)	11.98 » 02	545376G	545376	JF	215160G	215160	GC
<b>FIAT BRAVO II</b>							
<b>BRAVO II</b>							
(198)  Except 1,9D Multijet 16V 150, 2,0 (165) Except 	03.07 »	545624G	545624	JF	155625G	155625	SC
<b>FIAT CINQUECENTO</b>							
<b>CINQUECENTO</b>							
(170) 	92 »	545215G	545215	JF	115170G	115170	SC
<b>FIAT COUPE</b>							
<b>COUPE</b>							
(175, FA) 1.8 Special Plus inclus, 2.0 Turbo inclus	93 »				215160G	215160	GC
<b>FIAT CROMA</b>							
<b>CROMA 1</b>							
(154) 	85 » 09.86	545141G	545141	JF	555142G <sup>(1)</sup>	555142 <sup>(1)</sup>	JF
(154) 	10.86 » 97	545141G	545141	JF	555143G <sup>(1)</sup>	555143 <sup>(1)</sup>	JF
<b>CROMA 2</b>							
(194) 1.8, 1.9 JTD, 2.2, 2.4 JTD Except (SS)	05 »	545609G L 545600G R	545609 L 545600 R	JF	115685G <sup>(1)</sup>	115685 <sup>(1)</sup>	SC
<b>FIAT DAILY 4x2</b>							
<b>DAILY</b>							
 28	78 » 05.89	204051G <sup>(2)</sup>	204051 <sup>(2)</sup>	GC	214052G <sup>(2)</sup>	214052 <sup>(2)</sup>	GC























MODELE MODEL	ANNEE / YEAR						
		AVANT / FRONT			ARRIÈRE / REAR		
		GAZ / GAS	HYD	TYPE	GAZ / GAS	HYD	TYPE
<b>DAILY</b>							
 30.8:  → 304675	78 »	204051G <sup>(2)</sup>	204051 <sup>(2)</sup>	GC	214052G <sup>(2)</sup>	214052 <sup>(2)</sup>	GC
 35.8, 35.9, 35.10, 40.8, 40.10, 45.10, 49.10	78 » 05.89	204051G <sup>(2)</sup>	204051 <sup>(2)</sup>	GC	214052G <sup>(2)</sup>	214052 <sup>(2)</sup>	GC
 30.8:  304676 →	78 » 05.89	204908G <sup>(2)</sup>	204908 <sup>(2)</sup>	GC	214052G <sup>(2)</sup>	214052 <sup>(2)</sup>	GC
 30.8, 30.9	06.89 » 04.99	204908G <sup>(2)</sup>	204908 <sup>(2)</sup>	G	214023G <sup>(2)</sup>	214023 <sup>(2)</sup>	GC
 30.10, 35.8, 40.8, 40.10, 40.12	06.89 » 04.99	204969G <sup>(2)</sup> 204908G	204969 <sup>(2)</sup> 204908	GC	214023G <sup>(2)</sup>	214023 <sup>(2)</sup>	GC
 35.10, 45.10, 45.12, 49.10, 49.12	06.89 » 04.99	204969G <sup>(2)</sup> 204908G	204969 <sup>(2)</sup> 204908	GC	214994G <sup>(2)</sup>	214994 <sup>(2)</sup>	GC
 40NC35	06.89 » 04.99	204051G <sup>(2)</sup>	204051 <sup>(2)</sup>	GC	214052G <sup>(2)</sup>	214052 <sup>(2)</sup>	GC
<b>FIAT DOBLO</b>							
<b>DOBLO</b>							
(119, 223)   Except 	00 » 09.05	545550G	545550	JF	215561G	215561	GC
(119, 223)   Except 	10.05 » 12.09	545550G	545550	JF	215748G	215748	GC
<b>DOBLO 2</b>							
  Except Maxi, 	01.10 »	545801G L 545802G R	545801 L 545802 R	JF	215803G	215803	GC
<b>FIAT DOGAN</b>							
<b>DOGAN</b>							
(Egypt, Turkey) 		548222G	548222	JF			
<b>FIAT DUCATO</b>							
<b>DUCATO</b>							
(280) 	81 » 05.84	544960G	544960	JF	214809G	214809	GC
(280)   → 0284193 Except  	06.84 » 05.86	544960G	544960	JF	214809G	214809	GC



















MODELE MODEL	ANNEE / YEAR						
		AVANT / FRONT			ARRIÈRE / REAR		
		GAZ / GAS	HYD	TYPE	GAZ / GAS	HYD	TYPE
<b>DUCATO</b>							
 → 0278758	06.84 » 85	544960G	544960	JF	214809G	214809	GC
 0278759  → 0284193	85 » 05.86	544960G	544960	JF	214963G	214963	GC
 0284194 → Except  Express, Maxi	06.86 » 12.93	544040G	544040	JF	214809G	214809	GC
(280, 290) Express 10, 13, 15	06.86 » 12.93	544040G	544040	JF	214809G <sup>(4)</sup> 214963G	214809 <sup>(4)</sup> 214963	GC
(280, 290) Maxi DUCATO 1800Kg	06.86 » 12.93	544961G	544961	JF	714968G <sup>(4)</sup>	714968 <sup>(4)</sup>	PLL
(280, 290)  0284194 → Except  1800kg	06.86 » 12.93	544040G	544040	JF	214963G	214963	GC
(280, 290)  0284194 →  1800kg	06.86 » 12.93	544961G	544961	JF	<sup>(4)</sup>	<sup>(4)</sup>	
(230, 240)  1000kg (10 = 2.7t, 11 = 2.9t)  1400kg (14 = 3.1t, 15 = 3.3t)	01.94 » 05.06	545263G	545263	JF	215243G	215243	GC
(230,240) Maxi  1800kg (18=3.5t)	01.94 » 05.06	545505G	545505	JF	715244G	715244	PLL
(230 , 240)  Panorama	01.94 » 05.06		214963	JF	215243G	215243	GC
(250) 29L , 35C , 35S  Panorama Except  1800kg 	06.06 » 05.11	545828G	545828	JF	715861G 715862G 715863G	715861 715862 715863	PLL
(250) 29L , 35C , 35S  Panorama  Maxi  1800kg Except 	06.06 » 05.11	545830G	545830	JF	715861G 715862G 715863G	715861 715862 715863	PLL











MODELE MODEL	ANNEE / YEAR						
		AVANT / FRONT			ARRIÈRE / REAR		
		GAZ / GAS	HYD	TYPE	GAZ / GAS	HYD	TYPE
<b>FIAT FIORINO</b>							
<b>FIORINO</b>							
(127)  → 7017071 Made in EUR	77 » 06.82	544825G	544825	JF	554851G	554851	JF
(147)  7017072 → Made in EUR	07.82 » 84	544825G	544825	JF	554043G	554043	JF
 	07.93 »	548443G	548443	JF	558444G	558444	JF
(147)   Made in BR	82 » 87	544042G	544042	JF			
(146)   Made in BR	87 » 00	548442G	548442	JF	558444G	558444	JF
	08 »	545603G L 545604G R	545603 L 545604 R	JF	115752G	115752	SC
<b>FIORINO COMBI</b>							
	08 »	545603G L 545604G R	545603 L 545604 R	JF			
<b>FIORINO QUBO</b>							
 Panorama	08 »	545603G L 545604G R	545603 L 545604 R	JF	115752G	115752	SC
<b>FIAT GRANDE PUNTO</b>							
<b>GRANDE PUNTO</b>							
(199)  Except  Abarth	05 »	545603G L 545604G R	545603 L 545604 R	JF	155605G	155605	SC
<b>FIAT IDEA</b>							
<b>IDEA</b>							
(135)  	03 »	545599G	545599	JF	115590G	115590	SC
<b>FIAT LINEA</b>							
<b>LINEA</b>							
(323) 	07 »	545603G L 545604G R	545603 L 545604 R	JF			
<b>FIAT MAREA</b>							
<b>MAREA</b>							
(185)   Except 2.0, 2.4 (TD, JTD)	96 »	545377G	545377	JF	115378G	115378	SC















MODELE MODEL	ANNEE / YEAR						
		AVANT / FRONT			ARRIÈRE / REAR		
		GAZ / GAS	HYD	TYPE	GAZ / GAS	HYD	TYPE
<b>MAREA</b>							
(185)  2.0, 2.4 (TD, JTD)	96 »				115378G	115378	SC
(185)  Except 2.0, 2.4 (TD, JTD)	96 »	545377G	545377	JF	215318G	215318	GC
(185)  2.0, 2.4 (TD, JTD)	96 »				215318G	215318	GC
<b>FIAT MARENGO</b>							
<b>MARENGO</b>							
Base/Basis = TEMPRA Except 	90 »	545216G	545216	JF	215318G	215318	GC
<b>FIAT MULTIPLA</b>							
<b>MULTIPLA</b>							
(186)  Except Bi - Power	98 » 12.10	545405G	545405	JF	215406G	215406	GC
<b>FIAT PALIO</b>							
<b>PALIO</b>							
 Hatchback Type 1X	97 » 01	545541G <sup>(7)</sup>	545541 <sup>(7)</sup>	JF	255579G	255579	GC
 Hatchback Type 2H	01 »	545626G	545626	JF	255579G	255579	GC
 Types 1Y, PY	97 » 01	545541G <sup>(7)</sup>	545541 <sup>(7)</sup>	JF	215160G	215160	GC
 Type 2G, 2K	01 »	545626G	545626	JF	215160G	215160	GC
<b>FIAT PANDA</b>							
<b>PANDA 1</b>							
(141)  4x2	80 » 12.85	544915G <sup>(8)</sup>	544915 <sup>(8)</sup>	JF	114916G	114916	SC
(141)  4x2	01.86 » 08.03	544915G <sup>(8)</sup>	544915 <sup>(8)</sup>	JF	114970G	114970	SC
(141)  4x4	87 » 08.04	544943G <sup>(8)</sup>	544943 <sup>(8)</sup>	JF	114916G	114916	SC



























MODELE MODEL	ANNEE / YEAR						
		AVANT / FRONT			ARRIÈRE / REAR		
		GAZ / GAS	HYD	TYPE	GAZ / GAS	HYD	TYPE
<b>PANDA2</b>							
(169)  Except 1.4 16V  100 HP	09.03 » 02.12	545691G L 545692G R	545691 L 545692 R	JF	115693G	115693	SC
(169)  Climbing, Cross	09.04 » 10.12				215749G	215749	GC
(163) 	03.04 »	545691G L 545692G R	545691 L 545692 R	JF			
<b>PANDA 3</b>							
(312) 	03.12 »				115845G	115845	SC
<b>FIAT PUNTO</b>							
<b>PUNTO I</b>							
(176)  Except GT, SpoRTing (85,90), Diesel (D, TD)	93 » 09.99	545193G	545193	JF	115191G	115191	SC
(176)  Except GT , SpoRTing (85,90) , Diesel (D,TD)	94 » 01	545193G	545193	JF	115191G	115191	SC
(176)  1.2 SpoRTing 85, 1.6 SpoRTing 90, 1.4i GT Turbo, 1.7D, 1.7TD	93 » 09.99	545312G	545312	JF	115191G	115191	SC
(176)  1.2 SpoRTing 85, 1.6 SpoRTing 90, 1.4i GT Turbo, 1.7D, 1.7TD	94 » 01	545312G	545312	JF	115191G	115191	SC
<b>PUNTO II</b>							
(188)  Cult inclus 1.2 8V 60, 1.2 16V 80 Except SpoRTing	10.99 » 02.12	545497G	545497	JF	115498G	115498	SC
(188)  Cult inclus 1.3 JTD 70, 1.4 16V Except (SS)	03 » 02.12	545497G	545497	JF	115498G	115498	SC

























MODELE MODEL	ANNEE / YEAR						
		AVANT / FRONT			ARRIÈRE / REAR		
		GAZ / GAS	HYD	TYPE	GAZ / GAS	HYD	TYPE
<b>PUNTO II</b>							
 Cult inclus 1.9 D 60, 1.9 JTD 80, 1.9 JTD 85 Except (SS)	10.99 » 12.11	545528G	545528	JF	115498G	115498	SC
(188)  Cult inclus 1.2 16V 80 SpoRTing, 1.7 16V 130 HGT	10.99 » 12.11	545407G	545407	JF	115408G	115408	SC
(188)  Cult inclus 1.4 16V, 1.9 JTD (SS) HGT	03 » 12.11	545407G	545407	JF	115408G	115408	SC
<b>PUNTO III</b>							
(199)  Except (SS)	01.12 »	545603G L 545604G R	545603 L 545604 R	JF	155605G	155605	SC
<b>PUNTO EVO</b>							
(199)  Except Abarth, 	08 »	545603G L 545604G R	545603 L 545604 R	JF	155605G	155605	SC
<b>FIAT QUBO</b>							
<b>FIAT</b>							
 Panorama	08 »	545603G L 545604G R	545603 L 545604 R	JF	115752G	115752	SC
<b>FIAT REGATA</b>							
<b>REGATA</b>							
(138)  Except 	83 » 90	544964G	544964	JF	554769G	554769	JF
(138) 	84 » 90	544964G	544964	JF			
<b>FIAT RITMO &amp; STRADA</b>							
<b>RITMO I</b>							
(138)  Except 125 TC	78 » 09.82	544828G	544828	JF	554769G	554769	JF
(138) 125 TC	81 » 09.82				554769G	554769	JF





MODELE MODEL	ANNEE / YEAR						
		AVANT / FRONT			ARRIÈRE / REAR		
		GAZ / GAS	HYD	TYPE	GAZ / GAS	HYD	TYPE
<b>RITMO II</b>							
(138)  Except 125 TC, 130 TC	10.82 » 88	544964G	544964	JF	554769G	554769	JF
(138) 125 TC, 130 TC (Abarth)	10.82 » 88				554769G	554769	JF
<b>FIAT SCUDO</b>							
<b>SCUDO I</b>							
(220)   → 7609	95 » 07.97	545289G	545289	JF	<sup>(9)</sup> 215296G	<sup>(9)</sup> 215296	GC
(220)   7610 → 9792	08.97 » 09.03	545289G	545289	JF	<sup>(9)</sup> 215475G	<sup>(9)</sup> 215475	GC
(220) 1867   9793 → 10408	10.03 » 05.04				<sup>(9)</sup> 215475G	<sup>(9)</sup> 215475	GC
(220) 1867   10409 →	06.04 » 12.06	545289G	545289	JF	<sup>(9)</sup> 215475G	<sup>(9)</sup> 215475	GC
(220) 2000   9793 →	10.03 » 12.06				<sup>(9)</sup> 215475G	<sup>(9)</sup> 215475	GC
<b>SCUDO II</b>							
(270)  Except  Except 	01.07 » 06.11	545804G L 545805G R	545804 L 545805 R	JF	215840G	215840	GC
(270)   	01.07 » 06.11	545804G L 545805G R	545804 L 545805 R	JF	215851G	215851	GC
(270)  Except  Except 	01.07 »	545804G L 545805G R	545804 L 545805 R	JF	215840G	215840	GC
(270)   	01.07 »	545804G L 545805G R	545804 L 545805 R	JF	215851G	215851	GC



MODELE MODEL	ANNEE / YEAR						
		AVANT / FRONT			ARRIÈRE / REAR		
		GAZ / GAS	HYD	TYPE	GAZ / GAS	HYD	TYPE
<b>FIAT SEDICI</b>							
<b>SEDICI</b>							
  	06 »				155781G	155781	SC
<b>FIAT SEICENTO</b>							
<b>SEICENTO</b>							
(187)  Except Electra	98 »	545215G	545215	JF	115170G	115170	SC
<b>FIAT SIENA</b>							
<b>SIENA</b>							
(178) Type 2A 	96 » 01	545541G	545541	JF	255579G	255579	GC
(178) Type 2L 	01 » 12.11	545626G	545626	JF	255579G	255579	GC
<b>FIAT STILO</b>							
<b>STILO</b>							
(192)   Except 1.9 JTD 125, 135, 140, 150, 2.4 20V	01 » 06	545624G	545624	JF	155625G	155625	SC
(192)  1.9 JTD 125, 135, 140, 150, 2.4 20V	01 » 06				155625G	155625	SC
(192)   Except 1.9 JTD 125, 135, 140, 150 Except Up Road	03 » 06	545624G	545624	JF	115656G	115656	SC
(192)  1.9 JTD 125, 135, 140, 150, Except Up Road	03 » 06				115656G	115656	SC
<b>FIAT TALENTO</b>							
<b>TALENTO</b>							
(290) <sup>(3)</sup>   Except   	85 »	544040G	544040	JF	214809G <sup>(5)</sup>	214809 <sup>(5)</sup>	GC
(290) <sup>(3)</sup>   Except 	85 »	544961G	544961	JF	714968G <sup>(5)</sup>	714968 <sup>(5)</sup>	GC









MODELE MODEL	ANNEE / YEAR						
		AVANT / FRONT			ARRIÈRE / REAR		
		GAZ / GAS	HYD	TYPE	GAZ / GAS	HYD	TYPE
<b>TALENTO</b>							
(290) 	85 »	544040G	544040	JF	214963G <sup>(5)</sup>	214963 <sup>(5)</sup>	GC
<b>TALENTO 2</b>							
  Panorama	16 »				215597G	215597	GC
 	16 »				215597G	215597	GC
<b>FIAT TEMPRA (4x2)</b>							
<b>TEMPRA</b>							
(159)   1.4, 1.6	90 »	544058G	544058	JF	114059G	114059	SC
(159)   1.9 D	90 »	544058G	544058	JF	215160G	215160	GC
(159)   1.9 TD - 2.0i	90 »	545216G	545216	JF	215160G	215160	GC
(159)   1.4, 1.6, 1.9D Except 	90 »	544058G	544058	JF	215318G	215318	GC
(159)   1.8i, 1.9 TD, 2.0i Except 	90 »	545216G	545216	JF	215318G	215318	GC
<b>FIAT TIPO</b>							
<b>TIPO</b>							
(160) 1.1, 1.4, 1.6	88 »	544058G	544058	JF	114059G	114059	SC
(160) 1.7 D, 1.9 D	88 »	544058G	544058	JF	215160G	215160	GC
(160) 1.8i, 1.8 16V - 1.9TD, 2.0i, 2.0 16V	88 »	545216G	545216	JF	215160G	215160	GC
<b>FIAT ULYSSE</b>							
<b>ULYSSE 1</b>							
(220)   → 7609	94 » 08.97	545284G	545284	JF	215245G <sup>(10)</sup>	215245 <sup>(10)</sup>	GC













FIAT













FORD

MODELE MODEL	ANNEE / YEAR						
		AVANT / FRONT			ARRIÈRE / REAR		
		GAZ / GAS	HYD	TYPE	GAZ / GAS	HYD	TYPE
<b>ULYSSE 1</b>							
(220)  (1.7) 7610 →	09.97 » 08.02	545284G	545284	JF	<sup>(10)</sup> 215468G	<sup>(10)</sup> 215468	GC
<b>ULYSSE 2</b>							
(179) 	09.02 »	545676G L 545677G R	545676 L 545677 R	JF	215678G	215678	GC
<b>FIAT UNO</b>							
<b>UNO</b>							
(146)  Except Uno Turbo	83 »	544954G	544954	JF	154955G	154955	SC
<b>UNO MILLE (Made in Brazil)</b>							
	04 »	548443G	548443	JF	558444G	558444	JF

## FORD

<b>FORD EUROPE CAPRI</b>							
<b>CAPRI</b>							
 1300 → 2300	68 » 07.72		441848	FU		151863	SC
 1300 → 2600	08.72 » 02.74		444197	FU		151863	SC
Ghia, S 	76 » 78		444197	FU		151863	SC
<b>CAPRI II</b>							
 1300 → 3000	03.74 » 03.78		444197	FU		151863	SC
<b>CAPRI III</b>							
 Except 2.8, 3.0	04.78 » 88		444197	FU		151863	SC
<b>FORD EUROPE C-MAX</b>							
<b>C-MAX 1</b>							
 <sup>(1)</sup>	03 » 08.10	545671G L 545672G R	545671 L 545672 R	JF	155673G	155673	SC
<b>C-MAX 2</b>							
 <sup>(1)</sup>	09.10 »	545879G L 545870G R	545879 L 545870 R	JF	255790G	255790	GC
<b>GRAND C-MAX 2</b>							
 <sup>(1)</sup>	09.10 »	545879G L 545870G R	545879 L 545870 R	JF	255790G	255790	GC























MODELE MODEL	ANNEE / YEAR						
		AVANT / FRONT			ARRIÈRE / REAR		
		GAZ / GAS	HYD	TYPE	GAZ / GAS	HYD	TYPE
<b>FORD EUROPE CONSUL</b>							
<b>CONSUL</b>							
	71 » 75		204192	GC		151070	SC
<b>FORD EUROPE CORSAIR</b>							
<b>CORSAIR</b>							
	63 » 06.67		441772	FU		151742	SC
	07.67 » 72		441821	FU		151742	SC
<b>FORD EUROPE CORTINA</b>							
<b>CORTINA</b>							
MK I  1200, 1500 Except GT	62 » 08.66		441772 <sup>(2)</sup>	FU		151742	SC
MK I  1200, 1500	62 » 08.66		441772 <sup>(2)</sup>	FU			
MK II  1300, 1500	09.66 » 08.67		441770 <sup>(2)</sup>	FU		151742	SC
MK II  1300, 1500	09.66 » 08.67		441770 <sup>(2)</sup>	FU			
MK II  1300, 1600	09.67 » 08.70		441821 <sup>(2)</sup>	FU		151742	SC
MK II  1300, 1600	09.67 » 08.70		441821 <sup>(2)</sup>	FU			
MK III, MK IV 1300	09.70 » 82		101993	SC		111994	SC
MK III, MK IV 1600, 2000, 2300	09.70 » 82		204192	GC		111994	SC
<b>FORD EUROPE COUGAR</b>							
<b>COUGAR</b>							
(EC) 2.0, 2.5 V6	98 »	545517G	545517	JF	555518G	555518	JF
<b>FORD EUROPE COURRIER</b>							
<b>COURRIER</b>							
(Base/Basis = Fiesta III Ph 1) 	91 » 12.93	544008G	544008	JF	115222G	115222	SC























MODELE MODEL	ANNEE / YEAR						
		AVANT / FRONT			ARRIÈRE / REAR		
		GAZ / GAS	HYD	TYPE	GAZ / GAS	HYD	TYPE
<b>COURRIER</b>							
Base/Basis = Fiesta III Ph 1 	91 » 12.93	544008G	544008	JF	613216G	613216	RC
Conduite en charge/Load compensating							
Types F3, F5 	01.94 » 12.94	545219G	545219	JF	115222G	115222	SC
(Base/Basis = Fiesta III Ph 2)							
Types F3, F5 (Base/Basis = Fiesta III Ph 2) 	01.94 » 12.94	545219G	545219	JF	613216G	613216	RC
Conduite en charge/Load compensating							
Types F3, F5 	01.95 » 12.96	545219G	545219	JF	115222G	115222	SC
(Base/Basis = Fiesta III Ph 2 Classic)							
Types F3, F5 	01.95 » 12.96	545219G	545219	JF	613216G	613216	RC
(Base/Basis = Fiesta III Ph 2 Classic) Conduite en charge/Load compensating							
Types J3, J5 (Base/Basis = Fiesta IV) Essence/Petrol	10.95 »	545328G	545328	JF	115222G	115222	SC
Types J3, J5 (Base/Basis = Fiesta IV) Essence/Petrol Conduite en charge/Load compensating	10.95 »	545328G	545328	JF	613216G	613216	RC
Types J3, J5 (Base/Basis = Fiesta V) Diesel	10.95 »	545329G	545329	JF	115222G	115222	SC
Types J3, J5 (Base/Basis = Fiesta V) Diesel Conduite en charge/Load compensating	10.95 »	545329G	545329	JF	613216G	613216	RC
<b>FORD EUROPE ESCORT MK I, MK II</b>							
<b>ESCORT I</b>							
	68 » 09.73		441789	FU		111780	SC
Brake Estate, Van inclus Except Lotus Twin Cam, RS 1600, 2000, Mexico							















MODELE MODEL	ANNEE / YEAR						
		AVANT / FRONT			ARRIÈRE / REAR		
		GAZ / GAS	HYD	TYPE	GAZ / GAS	HYD	TYPE
<b>ESCORT I</b>							
Lotus Twin Cam - RS 1600, 2000, Mexico	68 » 09.73					111780	SC
<b>ESCORT I &amp; II</b>							
  Except RS (1800, 2000, Mexico)	10.73 » 07.80		444343	FU		154344	SC
 RS 1800	10.73 » 07.80		444197	FU		154344	SC
 RS 2000	10.73 » 74		444197	FU			
 RS 2000	75 » 07.80					154344	SC
 RS Mexico	10.73 » 07.80		444197	FU		154344	SC
 	10.73 » 07.80		444197	FU		111780	SC
<b>ESCORT II</b>							
	10.73 » 12.74		444343	FU		111780	SC
	01.75 » 80		444343	FU		111919	SC
<b>FORD EUROPE ESCORT MK III</b>							
<b>ESCORT III</b>							
  Diesel inclus Except XR3, XR3i	08.80 » 05.83	544860G	<sup>(4)</sup> 544860	JF	554871G	554871	JF
  Diesel inclus	08.80 » 05.83	544860G	<sup>(4)</sup> 544860	JF	554871G	554871	JF
 Express 35, 55	80 » 05.83				114802G	114802	SC
<b>FORD EUROPE ESCORT MK IV : Types AAF, ABF, ALF, ANF, AVF</b>							
<b>ESCORT IV</b>							
AAF, ABF, ALF, ANF, AVF   Essence/Petrol Except <b>A</b> , XR3i, 1.6i, RS	06.83 » 07.90	544944G	<sup>(4)</sup> 544944	JF	554871G	554871	JF
AAF, ABF, ALF, ANF, AVF   Essence/Petrol <b>A</b>	06.83 » 04.84	544944G	<sup>(4)</sup> 544944	JF	554871G	554871	JF

























MODELE MODEL	ANNEE / YEAR						
		AVANT / FRONT			ARRIÈRE / REAR		
		GAZ / GAS	HYD	TYPE	GAZ / GAS	HYD	TYPE
<b>ESCORT IV</b>							
AAF, ABF, ALF, ANF, AVF   Esence/Petrol <b>A</b>	05.84 » 12.85	(4) 544907G	(4) 544907	JF	554871G	554871	JF
AAF, ABF, ALF, ANF, AVF   Esence/Petrol <b>A</b>	01.86 » 07.90	(4) 544944G	(4) 544944	JF	554871G	554871	JF
AAF, ABF, ALF, ANF, AVF   Diesel 	06.83 » 12.85	(4) 544944G	(4) 544944	JF	554871G	554871	JF
AAF, ABF, ALF, ANF, AVF   Diesel 	01.86 » 07.90	(4) 544907G	(4) 544907	JF	554871G	554871	JF
AAF, ABF, ALF, ANF, AVF   Except XR3i	86 » 07.90	(4) 544944G	(4) 544944	JF	554871G	554871	JF
AAF, ABF, ALF, ANF, AVF  Express 35, 55	06.83 » 07.90	(4) 544907G	(4) 544907	JF	114802G	114802	SC
<b>FORD EUROPE ESCORT MK V : Types AAL, ABL, AFL, ALL, ANL, AVL</b>							
<b>ESCORT MK V</b>							
AAL, ABL, AFL, ALL, ANL, AVL  1.1, 1.3	08.90 » 12.94	(4) 544001G	(4) 544001	JF	314005G	314005	SR
AAL, ABL, AFL, ALL, ANL, AVL  1.4 Except 1.4i	08.90 » 10.90	(4) 544001G	(4) 544001	JF	314005G	314005	SR
AAL, ABL, AFL, ALL, ANL, AVL  1.8 Diesel Except TD	08.90 » 10.90	(4) 544001G	(4) 544001	JF	314005G	314005	SR
AAL, ABL, AFL, ALL, ANL, AVL  1.4 Except 1.4i	11.90 » 12.94	(4) 544002G	(4) 544002	JF	314005G	314005	SR
AAL, ABL, AFL, ALL, ANL, AVL  1.6 Except 1.6i, 16V	08.90 » 12.94	(4) 544002G	(4) 544002	JF	314005G	314005	SR
AAL, ABL, AFL, ALL, ANL, AVL  1.8i, Except 16V, Sport	92 » 12.94	(4) 544002G	(4) 544002	JF	314005G	314005	SR



























MODELE MODEL	ANNEE / YEAR						
		AVANT / FRONT			ARRIÈRE / REAR		
		GAZ / GAS	HYD	TYPE	GAZ / GAS	HYD	TYPE
<b>ESCORT MK V</b>							
AAL, ABL, AFL, ALL, ANL, AVL  1.8 Diesel	11.90 » 12.94	<sup>(4)</sup> 544002G	<sup>(4)</sup> 544002	JF	314005G	314005	SR
AAL, ABL, AFL, ALL, ANL, AVL  1.8 TD	08.90 » 12.94	<sup>(4)</sup> 544002G	<sup>(4)</sup> 544002	JF	314005G	314005	SR
AAL, ABL, AFL, ALL, ANL, AVL  1.4i, 1.6i, 1.6 16V	08.90 » 12.94	<sup>(4)</sup> 544002G	<sup>(4)</sup> 544002	JF	315187G	315187	SR
AAL, ABL, AFL, ALL, ANL, AVL  1.8i 16V, 1.8 Sport	92 » 12.94	<sup>(4)</sup> 544002G	<sup>(4)</sup> 544002	JF	315187G	315187	SR
AAL, ABL, AFL, ALL, ANL, AVL   RS 2000	91 » 12.94	<sup>(4)</sup> 545265G	<sup>(4)</sup> 545265	JF	315266G	315266	SR
AAL, ABL, AFL, ALL, ANL, AVL  RS Turbo  Except Cosworth	91 » 12.94	<sup>(4)</sup> 545265G	<sup>(4)</sup> 545265	JF			
AAL, ABL, AFL, ALL, ANL, AVL   XR3i, 16V inclus	08.90 » 12.94	<sup>(4)</sup> 544002G	<sup>(4)</sup> 544002	JF	315187G	315187	SR
AAL, ABL, AFL, ALL, ANL, AVL  Clipper 1.1, 1.3	08.90 » 12.94	<sup>(4)</sup> 544001G	<sup>(4)</sup> 544001	JF	114007G	114007	SC
AAL, ABL, AFL, ALL, ANL, AVL  Clipper 1.4 Except 1.4i	08.90 » 10.90	<sup>(4)</sup> 544001G	<sup>(4)</sup> 544001	JF	114007G	114007	SC
AAL, ABL, AFL, ALL, ANL, AVL  Clipper 1.8 Diesel Except Turbo Diesel	08.90 » 10.90	<sup>(4)</sup> 544001G	<sup>(4)</sup> 544001	JF	114007G	114007	SC
AAL, ABL, AFL, ALL, ANL, AVL  Clipper 1.4, Except 1.4i	11.90 » 12.94	<sup>(4)</sup> 544002G	<sup>(4)</sup> 544002	JF	114007G	114007	SC
AAL, ABL, AFL, ALL, ANL, AVL  Clipper 1.4i	08.90 » 12.94	<sup>(4)</sup> 544002G	<sup>(4)</sup> 544002	JF	114007G	114007	SC
AAL, ABL, AFL, ALL, ANL, AVL  Clipper 1.6i 16V inclus	08.90 » 12.94	<sup>(4)</sup> 544002G	<sup>(4)</sup> 544002	JF	114007G	114007	SC











MODELE MODEL	ANNEE / YEAR						
		AVANT / FRONT			ARRIÈRE / REAR		
		GAZ / GAS	HYD	TYPE	GAZ / GAS	HYD	TYPE
<b>ESCORT MK V</b>							
AAL, ABL, AFL, ALL, ANL, AVL  Clipper 1.8i, 1.8 16V	92 » 12.94	(4) 544002G	(4) 544002	JF	114007G	114007	SC
AAL, ABL, AFL, ALL, ANL, AVL  1.8D Except TD	11.90 » 12.94	(4) 544002G	(4) 544002	JF	114007G	114007	SC
AAL, ABL, AFL, ALL, ANL, AVL  Clipper 1.8 TD	08.90 » 12.94	(4) 544002G	(4) 544002	JF	114007G	114007	SC
AAL, ABL, AFL, ALL, ANL, AVL  Express/Livraison/Kombi 500kg	(5) 08.90 » 12.94	(4) 544001G	(4) 544001	JF	115264G	115264	SC
AAL, ABL, AFL, ALL, ANL, AVL  Express/Livraison/Kombi 700kg	(5) 08.90 » 12.94	(4) 544002G	(4) 544002	JF	115264G	115264	SC
<b>FORD EUROPE ESCORT MK VI (4x2) : Types AAL, ABL, AFL, ALL, ANL, AVL</b>							
<b>ESCORT VI</b>							
AAL, ABL, AFL, ALL, ANL, AVL   1.3, 1.4, 1,6 8V	01.95 » 08.95	(4) 545323G	(4) 545323	JF	355326G	355326	SR
AAL, ABL, AFL, ALL, ANL, AVL    1.3, 1.4, 1,6 8V	09.95 »	(4) 545323G	(4) 545323	JF	355470G	355470	SR
AAL, ABL, AFL, ALL, ANL, AVL   1.4	01.95 » 04.95	(4) 545323G	(4) 545323	JF	355326G	355326	SR
AAL, ABL, AFL, ALL, ANL, AVL   1.4	05.95 » 08.95	(4) 545323G	(4) 545323	JF	355325G	355325	SR
AAL, ABL, AFL, ALL, ANL, AVL   1.6 16V, 1.8 16V Except XR3i	01.95 » 08.95	(4) 545324G	(4) 545324	JF	355470G	355470	SR
AAL, ABL, AFL, ALL, ANL, AVL   1.6 16V, 1.8 16V Except XR3i	09.95 »	(4) 545324G	(4) 545324	JF	355325G	355325	SR
AAL, ABL, AFL, ALL, ANL, AVL   1.6 XR3i, 1.8 XR3i	09.95 »	(4) 545324G	(4) 545324	JF	355481G	355481	SR

















MODELE MODEL	ANNEE / YEAR						
		AVANT / FRONT			ARRIÈRE / REAR		
		GAZ / GAS	HYD	TYPE	GAZ / GAS	HYD	TYPE
<b>ESCORT VI</b>							
AAL, ABL, AFL, ALL, ANL, AVL   1.8D, 1.8TD	01.95 » 08.95	<sup>(4)</sup> 545324G	<sup>(4)</sup> 545324	JF	355470G	355470	SR
AAL, ABL, AFL, ALL, ANL, AVL   1.8D, 1.8TD	09.95 »	<sup>(4)</sup> 545324G	<sup>(4)</sup> 545324	JF	355325G	355325	SR
AAL, ABL, AFL, ALL, ANL, AVL   	01.95 » 08.95	<sup>(4)</sup> 545324G	<sup>(4)</sup> 545324	JF	355470G	355470	SR
AAL, ABL, AFL, ALL, ANL, AVL   	09.95 »	<sup>(4)</sup> 545324G	<sup>(4)</sup> 545324	JF	355325G	355325	SR
AAL, ABL, AFL, ALL, ANL, AVL  Clipper  1.3, 1.4, 1.6 8V	01.95 » 08.95	<sup>(4)</sup> 545323G	<sup>(4)</sup> 545323	JF	<sup>(6)</sup> 114007G	<sup>(6)</sup> 114007	SC
AAL, ABL, AFL, ALL, ANL, AVL  Clipper  1.3, 1.4, 1.6 8V	09.95 »	<sup>(4)</sup> 545323G	<sup>(4)</sup> 545323	JF	<sup>(6)</sup> 115327G	<sup>(6)</sup> 115327	SC
AAL, ABL, AFL, ALL, ANL, AVL  Clipper  1.6 16V, 1.8 16V, 1.8D, 1.8TD	01.95 » 08.95	<sup>(4)</sup> 545324G	<sup>(4)</sup> 545324	JF	<sup>(6)</sup> 114007G	<sup>(6)</sup> 114007	SC
AAL, ABL, AFL, ALL, ANL, AVL  Clipper  1.6 16V, 1.8 16V, 1.8D, 1.8TD	09.95 »	<sup>(4)</sup> 545324G	<sup>(4)</sup> 545324	JF	<sup>(6)</sup> 115327G	<sup>(6)</sup> 115327	SC
AAL, ABL, AFL, ALL, ANL, AVL <sup>(5)</sup>  Express/Livraison 500kg 700kg	01.95 »	<sup>(4)</sup> 545324G	<sup>(4)</sup> 545324	JF	115264G	115264	SC
<b>FORD EUROPE FIESTA MK I</b>							
<b>FIESTA MK I</b>							
 Except XR 2	76 » 08.83	544451G	544451	JF	554452G	554452	JF
XR 2	81 » 08.83	544881G	544881	JF	554452G	554452	JF
	76 » 08.83	544451G	544451	JF	554452G	554452	JF
<b>FORD EUROPE FIESTA MK II</b>							
<b>FIESTA MK II</b>							
 Except XR 2	09.83 » 03.89	544947G	544947	JF	554452G	554452	JF
XR 2	09.83 » 89	544977G	544977	JF	554452G	554452	JF























MODELE MODEL	ANNEE / YEAR						
		AVANT / FRONT			ARRIÈRE / REAR		
		GAZ / GAS	HYD	TYPE	GAZ / GAS	HYD	TYPE
<b>FIESTA MK II</b>							
	09.83 » 03.89	544947G	544947	JF	554452G	554452	JF
<b>FORD EUROPE FIESTA MK III Phase 1</b>							
<b>FIESTA MK III Ph 1</b>							
1.0, 1.1, 1.3, 1.4 Except <b>A</b> 1.6, 1.8 Diesel (-) 	04.89 » 12.93	544044G <sup>(7)</sup>	544044 <sup>(7)</sup>	JF	314045G	314045	SR
1.1S, 1.3SX, 1.4 <b>A</b> 1.4 S, 1.6 S, 1.8 Si, 1.8 TD Calypso, Family, Flight Ghia (+) 	04.89 » 12.93	544008G	544008 <sup>(7)</sup>	JF	314045G	314045	SR
XR2i, RS 1800	04.89 » 12.93	544008G	544008 <sup>(7)</sup>	JF	314045G	314045	SR
Turbo, Essence/Petrol	90 » 12.93	545169G	545169 <sup>(7)</sup>	JF	314099G	314099	SR
 Except Courier (voir/see FORD COURRIER)	04.89 » 12.93	544044G	544044 <sup>(7)</sup>	JF	314045G	314045	SR
<b>FORD EUROPE FIESTA MK III Phase 2</b>							
<b>FIESTA III Ph 2</b>							
(FA, FB, FV, GF) Classic 09.95 > 12.96 inclus 1.1, 1.3, 1.4  Except SX, Si, Futura (-) 	01.94 » 12.96	545217G <sup>(7)</sup>	545217 <sup>(7)</sup>	JF	315210G	315210	SR
(FA, FB, FV, GF) Classic 09.95 > 12.96 inclus 1.1, 1.3, 1.4 SX, Si, Futura (+) 	01.94 » 12.96	545219G <sup>(3) (7)</sup>	545219 <sup>(3) (7)</sup>	JF	315210G	315210	SR
(FA, FB, FV, GF) Classic 09.95 > 12.96 inclus 1.6 Ghia	01.94 » 12.96	545219G <sup>(3) (7)</sup>	545219 <sup>(3) (7)</sup>	JF	315210G	315210	SR
(FA, FB, FV, GF) Classic 09.95 > 12.96 inclus 1.6 LX, Si, Futura	01.94 » 12.96	545219G <sup>(7)</sup>	545219 <sup>(7)</sup>	JF	315221G	315221	SR
(FA, FB, FV, GF) Classic 09.95 > 12.96 inclus 1.8 XR2i, 1.8 RS	01.94 » 12.96	545219G <sup>(7)</sup>	545219 <sup>(7)</sup>	JF	315221G	315221	SR

























MODELE MODEL	ANNEE / YEAR						
		AVANT / FRONT			ARRIÈRE / REAR		
		GAZ / GAS	HYD	TYPE	GAZ / GAS	HYD	TYPE
<b>FIESTA III Ph 2</b>							
(FA, FB, FV, GF) Classic 09.95 > 12.96 inclus 1.8 D (1.8 Diesel) Except Turbo Diesel	01.94 » 12.96	(7) 545217G	(7) 545217	JF	315210G	315210	SR
(FA, FB, FV, GF) Classic 09.95 > 12.96 inclus 1.8 TD (1.8 Turbo Diesel)	01.94 » 12.96	(7) 545219G	(7) 545219	JF	315221G	315221	SR
(FA, FB, FV, GF) Classic 09.95 > 12.96 inclus  Except Courier (Voir/see FORD COURRIER)	01.94 » 12.96	(7) 545217G	(7) 545217	JF	315210G	315210	SR
<b>FORD EUROPE FIESTA MK IV: Types JA, JB, JV 09.95 &gt; 02.02</b>							
<b>FIESTA IV</b>							
(JA, JB, JV)   Essence/Petrol Except Courier	09.95 » 09.98	(7) 545328G	(7) 545328	JF	355320G	355320	SR
(JA, JB, JV)   Essence/Petrol Except Courier	10.98 » 02.02	(7) 545328G	(7) 545328	JF	355479G	355479	SR
(JA, JB, JV)   Diesel Except Courier	09.95 » 09.98	(7) 545329G	(7) 545329	JF	355320G	355320	SR
(JA, JB, JV)   Diesel Except Courier	10.98 » 02.02	(7) 545329G	(7) 545329	JF	355479G	355479	SR
<b>FORD EUROPE FIESTA MK V: Type JD, JH</b>							
<b>FIESTA V</b>							
(JD, JH)  Except RS, ST (2.0)	03.02 » 09.08	545641G L 545642G R	545641 L 545642 R	JF	155643G	155643	SC
<b>FORD EUROPE FIESTA MK VI</b>							
<b>FIESTA MK VI</b>							
 Except ST	10.08 »	545705G L 545706G R	545705 L 545706 R	JF	155707G	155707	SC
	01.09 »	545705G L 545706G R	545705 L 545706 R	JF	155707G	155707	SC

















MODELE MODEL	ANNEE / YEAR						
		AVANT / FRONT			ARRIÈRE / REAR		
		GAZ / GAS	HYD	TYPE	GAZ / GAS	HYD	TYPE
<b>FORD EUROPE FIGO</b>							
<b>FIESTA FIGO</b>							
	10 »	545641G L 545642G R	545641 L 545642 R	JF	155643G	155643	SC
<b>FORD EUROPE FOCUS I</b>							
<b>FOCUS I</b>							
(DAW, DBW, DFW)   Except C-MAX, RS	<sup>(1)</sup> 98 » 09.04	545409G L 545400G R	545409 L 545400 R	JF	155511G	155511	SC
(DNW)  Clipper 	<sup>(1)</sup> 98 » 09.04	545409G L 545400G R	545409 L 545400 R	JF	115512G	115512	SC
<b>FORD EUROPE FOCUS II Except C-MAX</b>							
<b>FOCUS II</b>							
   Except C-MAX, <sup>(S)</sup> 2.5T 20V	<sup>(1)</sup> 10.04 » 02.11	545671G L 545672G R	545671 L 545672 R	JF	155673G	155673	SC
	<sup>(1)</sup> 10.04 » 02.11	545671G L 545672G R	545671 L 545672 R	JF	115684G <sup>(6)</sup>	115684 <sup>(6)</sup>	SC
<b>FORD EUROPE FOCUS III Except C-MAX</b>							
<b>FOCUS III</b>							
 Except ST	<sup>(1)</sup> 03.11 »	545879G L 545870G R	545879 L 545870 R	JF	255790G	255790	GC
	<sup>(1)</sup> 03.11 »	545879G L 545870G R	545879 L 545870 R	JF	255790G	255790	GC
	<sup>(1)</sup> 03.11 »	545879G L 545870G R	545879 L 545870 R	JF	115850G <sup>(6)</sup>	115850 <sup>(6)</sup>	SC
<b>FORD EUROPE FUSION</b>							
<b>FUSION</b>							
(JU) 	02 »	545650G L 545661G R	545650 L 545661 R	JF	155662G	155662	SC
<b>FORD EUROPE GALAXY</b>							
<b>GALAXY 1</b>							
(WGR) 	95 » 03.06	545336G	545336	JF	115337G <sup>(6)</sup>	115337 <sup>(6)</sup>	SC
<b>GALAXY 2</b>							
(WA6) 	04.06 » 03.15	545737G L 545738G R	545737 L 545738 R	JF	255741G <sup>(6)</sup>	255741 <sup>(6)</sup>	GC
<b>FORD EUROPE GRANADA</b>							
<b>GRANADA</b>							
(GG, GN, GU) 	71 » 84		204192	GC		151070	SC



MODELE MODEL	ANNEE / YEAR						
		AVANT / FRONT			ARRIÈRE / REAR		
		GAZ / GAS	HYD	TYPE	GAZ / GAS	HYD	TYPE
<b>FORD EUROPE KA</b>							
<b>KA 1</b>							
 (RB)	96 » 09.98	545338G	545338	JF	355339G	355339	SR
 (RB)	10.98 » 03.00	545338G	545338	JF	355545G	355545	SR
 (RB)	04.00 » 04.03	545338G	545338	JF	355546G	355546	SR
 (RB)	05.03 » 01.08	545753G L 545754G R	545753 L 545754 R	JF	355546G	355546	SR
<b>SPORT KA</b>							
 SPORT KA	02 » 04.03	545338G	545338	JF	355546G	355546	SR
<b>STREET KA</b>							
STREET KA	02 » 04.03				355546G	355546	SR
<b>SPORT KA &amp; STREET KA</b>							
 SPORT KA STREET KA	05.03 »	545753G L 545754G R	545753 L 545754 R	JF	355546G	355546	SR
<b>KA 2</b>							
	10.08 »	545744G L 545745G R	545744 L 545745 R	JF	115746G	115746	SC
<b>FORD EUROPE MAVERICK</b>							
<b>MAVERICK</b>							
(R20)  4x4  KB, KV, TV	93 » 06.96	245112G	245112	GC	214006G	214006	GC
(UDS, UNS)  2 Portes/Doors MFD	07.96 » 00	245112G	245112	GC	215113G	215113	GC
(UDS, UNS)  4 Portes/Doors MFD	07.96 » 00	245112G	245112	GC	215113G	215113	GC
<b>FORD EUROPE MONDEO I &amp; II</b>							
<b>MONDEO I</b>							
   (1) Except Si, (SS)	92 » 05.93				555225G	555225	JF
   (1) Except Si, (SS)	06.93 » 09.96	545223G	545223	JF	555225G	555225	JF
   (1) Si, (SS)	06.93 » 09.96	545223G	545223	JF			













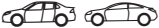











MODELE MODEL	ANNEE / YEAR						
		AVANT / FRONT			ARRIÈRE / REAR		
		GAZ / GAS	HYD	TYPE	GAZ / GAS	HYD	TYPE
<b>MONDEO I</b>							
 Clipper	(1) 92 » 05.93				(6) 215227G	(6) 215227	GC
 Clipper	(1) 06.93 » 09.96	545223G	545223	JF	(6) 215227G	(6) 215227	GC
<b>MONDEO II</b>							
(BAP, BFP)  Except (SS)	(1) 10.96 » 10.00	545335G	545335	JF	555225G	555225	JF
(BNP)  Clipper	(1) 10.96 » 10.00	545335G	545335	JF	(6) 215227G	(6) 215227	GC
<b>FORD EUROPE MONDEO III &amp; IV</b>							
<b>MONDEO III</b>							
(B4Y, B5Y)  Except (18), (SS) Except 	(1) 11.00 » 05.07	545558G	545558	JF	555559G	555559	JF
(B4Y, B5Y)  (18) Except (SS) Except 	(1) 11.00 » 05.07	545558G	545558	JF			
(BWY)  Clipper Except (SS) Except 	(1) 11.00 » 05.07	545558G	545558	JF			
<b>MONDEO IV</b>							
(BA7) 	(1) 06.07 » 10.14	545737G L 545738G R	545737 L 545738 R	JF	(6) 255741G	(6) 255741	GC
(BA7) 	(1) 06.07 » 10.14	545737G L 545738G R	545737 L 545738 R	JF	(6) 255741G	(6) 255741	GC
<b>FORD EUROPE ORION</b>							
<b>ORION</b>							
(AFD, AFF) Essence/Petrol  Except Orion i	83 » 07.90	544944G	544944	JF	554871G	554871	JF
(AFD, AFF) Diesel	83 » 12.85	544944G	544944	JF	554871G	554871	JF























MODELE MODEL	ANNEE / YEAR						
		AVANT / FRONT			ARRIÈRE / REAR		
		GAZ / GAS	HYD	TYPE	GAZ / GAS	HYD	TYPE
<b>ORION</b>							
(AFD, AFF) Diesel	01.86 » 07.90	544907G	544907	JF	554871G	554871	JF
(GAL) 1.3	08.90 » 95	544001G	544001	JF	314005G	314005	SR
(GAL) 1.4	08.90 » 10.90	544001G	544001	JF	314005G	314005	SR
(GAL) 1.8 Diesel	08.90 » 10.90	544001G	544001	JF	314005G	314005	SR
(GAL) 1.4	11.90 » 95	544002G	544002	JF	314005G	314005	SR
(GAL) 1.6	08.90 » 95	544002G	544002	JF	314005G	314005	SR
(GAL) 1.8 Diesel	11.90 » 95	544002G	544002	JF	314005G	314005	SR
(GAL) 1.8 Turbo Diesel	08.90 » 95	544002G	544002	JF	314005G	314005	SR
(GAL) 1.4i, 1.6i Except Ghia	08.90 » 95	544002G	544002	JF	314005G	314005	SR
(GAL) 1.8i Except Ghia	92 » 95	544002G	544002	JF	314005G	314005	SR
(GAL) 1.4i Ghia 1.6i Ghia	08.90 » 95	544002G	544002	JF	315187G	315187	SR
(GAL) 1.8i Ghia	92 » 95	544002G	544002	JF	315187G	315187	SR
<b>FORD EUROPE PUMA</b>							
<b>PUMA</b>							
(EC) 	97 » 09.98	545328G	545328	JF	355320G	355320	SR
(EC) 	10.98 »	545328G	545328	JF	355320G	355320	SR
<b>FORD EUROPE RANGER</b>							
<b>RANGER</b>							
2.5D	10.99 » 04.02	145022G	145022	SC	118668G	118668	SC
2.5TD	04.02 »	145022G	145022	SC	118668G	118668	SC





















MODELE MODEL	ANNEE / YEAR						
		AVANT / FRONT			ARRIÈRE / REAR		
		GAZ / GAS	HYD	TYPE	GAZ / GAS	HYD	TYPE
<b>FORD EUROPE SCORPIO &amp; GRANADA</b>							
<b>SCORPIO &amp; GRANADA</b>							
(GAE)  Except  24V	85 » 10.94	545102G	545102	JF	214953G	214953	GC
(GGE) 	92 » 10.94	545102G	545102	JF			
<b>FORD EUROPE SIERRA</b>							
<b>SIERRA</b>							
(GB)    Except XR4i	82 » 05.84	544890G	544890	JF	114801G	114801	SC
(GB)    Except RS Cosworth, XR4i	06.84 » 93	544061G	544061	JF	114801G	114801	SC
(BN)  	82 » 05.84	544890G	544890	JF	<sup>(6)</sup> 155132G	<sup>(6)</sup> 155132	SC
(BN)  	06.84 » 93	544061G	544061	JF	<sup>(6)</sup> 155132G	<sup>(6)</sup> 155132	SC
(BN)  	06.84 » 93				<sup>(6)</sup> 155132G	<sup>(6)</sup> 155132	SC
<b>FORD EUROPE S-MAX</b>							
<b>S-MAX</b>							
(WA6)  5,7 Places/Seats 	06 » 01.15	545737G L 545738G R	545737 L 545738 R	JF	<sup>(6)</sup> 255741G	<sup>(6)</sup> 255741	GC
<b>FORD EUROPE TAUNUS</b>							
<b>TAUNUS P4</b>							
12 M  	62 » 08.66		141518	SC		171159	SC
12 M 	62 » 08.66		141518	SC		151585	SC
<b>TAUNUS P6</b>							
12 M, 15M	09.66 » 08.70		441837	FU		171667	SC
<b>TAUNUS</b>							
17 M, 20 M, 26 M  703919 →	09.63 » 71		441788	FU		151149	SC
1300 (55 PS)	09.70 » 83		101993	SC		111994	SC
1600 (72 PS - 88 PS)	09.70 » 83		204192	GC		111994	SC

















MODELE MODEL	ANNEE / YEAR						
		AVANT / FRONT			ARRIÈRE / REAR		
		GAZ / GAS	HYD	TYPE	GAZ / GAS	HYD	TYPE
<b>TAUNUS</b>							
2000 (90 PS)	09.70 » 83		204192	GC		111994	SC
2300 (108 PS)	09.70 » 83		204192	GC		111994	SC
<b>FORD EUROPE TOURNEO CONNECT</b>							
<b>TOURNEO CONNECT</b>							
 (5)	02 » 06.13	545617G	545617	JF	115619G (6)	115619 (6)	SC
 (5)	02 » 06.13	545617G	545617	JF	115619G (6)	115619 (6)	SC
<b>FORD EUROPE TRANSIT MK I</b>							
<b>THAMES TRADER</b>							
30 cwt (3, 4, 5 tonnes)	56 » 65					871718	PL
<b>TRANSIT I</b>							
Types E1 → E 6  FT : 600, 900, 1000, 1100, 1300, 1500, 1750	65 » 08.70		101861	SC		211862	GC
FT : 75, 100, 115   2,69m/WB 106"	09.70 » 77		201043	GC		214537	GC
FT : 125, 130, 150, 175   3,00 m/WB 118"	09.70 » 77		201043	GC		211044	GC
FT : 75, 100, 125, 130, 150, 175   3,00 m/WB 118"	09.70 » 77		201043	GC		211044	GC
  2,69 m/WB 106"	09.70 » 77		201043	GC		214537	GC
  3,00 m/WB 118"	09.70 » 77		201043	GC		211044	GC
(V) 80, 100, 120   2,69 m/WB 106"	78 » 10.85		201043	GC		214537	GC
(V) 100, 120   2,69 m/WB 106"	78 » 10.85		201043	GC		211044	GC
(V) 100 L, 130, 150, 160, 175, 190   3,00 m/WB 118"	78 » 10.85		201043	GC		211044	GC







MODELE MODEL	ANNEE / YEAR						
		AVANT / FRONT			ARRIÈRE / REAR		
		GAZ / GAS	HYD	TYPE	GAZ / GAS	HYD	TYPE
<b>TRANSIT I</b>							
(V)   2,69 m/WB 106"	78 » 10.85		201043	GC		211044	GC
(V)   3,00 m/WB 118"	78 » 10.85		201043	GC		214537	GC
<b>FORD EUROPE TRANSIT MK II , MKIII</b>							
<b>TRANSIT II</b>							
(T) 80, 100, 115, 120  2,81m/WB 111"	11.85 » 07.91	544989G	544989	JF	714988G	714988	PLL
(T) 100 L, 130, 150, 160, 175, 190  3,02 m, 3,47 m/WB 119", 137"	11.85 » 07.91	744987G	744987	PLL	714988G	714988	PLL
<b>TRANSIT III</b>							
(E) 80, 100, 115, 115 L, 120  2,84 m/WB 112"	08.91 » 12.99	545229G	545229	JF	215220G	215220	GC
100 L, 120 L, 130, 150 L, 150 S, 190 L  3,57 m/WB 141"	08.91 » 12.99	545229G	545229	JF	215231G	215231	GC
(E) 150 S  2,84 m/WB 112"	08.91 » 12.99	545229G	545229	JF	215231G	215231	GC
(E) 190, 190EF  3,5 m/WB 141"	08.91 » 12.99	545229G	545229	JF	215220G	215220	GC
<b>FORD EUROPE TRANSIT MK IV, Except Connect</b>							
<b>TRANSIT IV</b>							
PROLPUSSION/RWD  	01.00 » 04.06	545708G	545708	JF	115811G	115811	SC
PROLPUSSION/RWD 	01.00 » 04.06	545708G	545708	JF	115812G	115812	SC
TRACTION/FWD  	01.00 » 04.06	545708G	545708	JF	115709G	115709	SC
TRACTION/FWD 	01.00 » 04.06	545708G	545708	JF	115700G	115700	SC









MODELE MODEL	ANNEE / YEAR						
		AVANT / FRONT			ARRIÈRE / REAR		
		GAZ / GAS	HYD	TYPE	GAZ / GAS	HYD	TYPE
<b>TRANSIT V</b>							
 PROLPULSION/RWD 300 L, 300 M, 330 L, 330 M, 350 E, 350 M Except 3.2	05.06 » 04.14	545920G	545920	JF	115811G	115811	SC
 PROLPULSION/RWD 300 S, 330 S, 430 E Except 3.2	05.06 » 04.14	545920G	545920	JF	115933G	115933	SC
 TRACTION/FWD Except 3.2	05.06 » 04.14	545920G	545920	JF	115933G	115933	SC
 TRACTION/FWD Except 3.2	05.06 » 04.14	545920G	545920	JF	115933G	115933	SC
 TRACTION/FWD Except 3.2	05.06 » 04.14	545929G	545929	JF	115931G	115931	SC
 TRACTION/FWD Except 350 E, 3.2	05.06 » 04.14	545929G	545929	JF	115931G	115931	SC
 TRACTION/FWD 350 E Except 3.2	05.06 » 04.14	545920G	545920	JF	115933G	115933	SC
 TRACTION/FWD Except 350 L Plancher Cabine/Floor Cabin, 3.2	05.06 » 04.14	545929G	545929	JF	115932G	115932	SC
 TRACTION/FWD 350 L Plancher Cabine/Floor Cabin, 3.2	05.06 » 04.14	545920G	545920	JF	115931G	115931	SC
<b>FORD EUROPE TRANSIT CONNECT</b>							
<b>TRANSIT CONNECT</b>							
 550 <sub>kg</sub> / 625 <sub>kg</sub>	02 » 06.13	545617G	545617	JF	115619G	115619	SC
 725 <sub>kg</sub> / 750 <sub>kg</sub> / 825 <sub>kg</sub>	02 » 06.13	545617G	545617	JF	115619G	115619	SC
<b>FORD EUROPE VEDETTE</b>							
<b>VEDETTE</b>							
	49 » 55		161141	SC		171142	SC



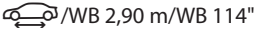

MODELE MODEL	ANNEE / YEAR						
		AVANT / FRONT			ARRIÈRE / REAR		
		GAZ / GAS	HYD	TYPE	GAZ / GAS	HYD	TYPE



## FREIGHT ROVER

SHERPA							
185, 215, 220, 230, 240, 250	74 » 06.82				215145G	215145	GC
 180, 215, 220, 240, 250	07.82 »				215145G	215145	GC
 255	07.82 »	145146G	145146	SC	215145G	215145	GC
SHERPA 200							
 200, 230, 250, 280	83 »	105137G	105137	SC	215138G	215138	GC
 255, 280	83 »	145146G	145146	SC			
SHERPA 300							
285, 310  /WB 2,90 , 3,20 m/WB 114" , 126"	83 »	205119G	205119	GC	215110G	215110	GC
350  /WB 2,90 m/WB 114"	83 »	205119G	205119	GC	215110G	215110	GC
350  /WB 3,20 , 3,60 m/WB 126" , 142"	83 »	205119G	205119	GC	715121G	715121	PLL





## HANOMAG HENSCHEL

F - SERIES							
F20, F25, F30, F35 Except  AR/Rear	67 » 72			201092	GC		
F20, F25, F30, F35  AR/Rear	73 »			201092	GC	114381	SC

## HILLMAN

AVENGER							
1250,1300,1500, 1600	70 » 75			444353	FU	154354	SC
1300, 1600	76 » 81			444685	FU	154686	SC
HUNTER							
 67 »				441998	FU	151999	SC
 70 »				441998	FU	111366	SC
IMP							
 63 »						151558	SC









MODELE MODEL	ANNEE / YEAR						
		AVANT / FRONT			ARRIÈRE / REAR		
		GAZ / GAS	HYD	TYPE	GAZ / GAS	HYD	TYPE
<b>MINX</b>							
V, VI Series 	63 » 67		141561	SC		171159	SC
	67 » 70		441998	FU		151999	SC
	67 » 70		441998	FU		111366	SC



## HINO

<b>CONTESSA</b>							
1300 			141751	SC		251752	GC



## HONDA

<b>HONDA ACCORD , VIGOR</b>							
<b>ACCORD &amp; VIGOR</b>							
SY, SZ 	09.81 » 05.83	544909G	544909	JF	554900G		JF
AC, AD 	06.83 » 05.83	544909G	544909	JF	554900G		JF
<b>HONDA CIVIC &amp; BALLADE</b>							
<b>CIVIC</b>							
120,013,001,500	72 » 75		444206	FU		454207	FU
<b>CIVIC &amp; BALLADE</b>							
 OS, SL, SR, SS, ST	79 » 83	544011G		JF	554012G		JF
 AG, AH, AJ, AK, AL, AM	84 » 09.87	544013G	544013	JF	354014G	354014	SR
 CRX, AE, AF, AS	84 » 09.87	544013G	544013	JF	354014G	354014	SR
 Van, VC, VE, WD	79 » 83	544011G		JF	104534G	104534	SC
<b>HONDA CONCERTO --&gt; Z</b>							
<b>INTEGRA</b>							
	85 » 89	544013G	544013	JF	354014G	354014	SR
<b>QUINT</b>							
AV, DA	85 » 89	544013G	544013	JF	354014G	354014	SR
<b>QUINTET</b>							
SU, TE, TL, TS, TU	80 » 85	544011G	544011	JF	554012G		JF













MODELE MODEL	ANNEE / YEAR						
		AVANT / FRONT			ARRIÈRE / REAR		
		GAZ / GAS	HYD	TYPE	GAZ / GAS	HYD	TYPE











## HUMBER

SCEPTRE							
MK I - MK II 	63 » 67		141561	SC		111366	SC
MK III 	67 » 76		441998	FU		151999	SC
MK III 	74 » 76		441998	FU		111366	SC

## HYUNDAI

ATOS & ATOS PRIME								
	97 »					115769G	115769	SC
ACCENT III								
(MC) 1,4 GL, 1,5 CRDi GLS, 1,6LS 	11.05 » 09.11	545898G L 545899G R	545898 L 545899 R	JF		155890RG	155890R	SC
(MC) 1,4 GL, 1,5 CRDi GLS, 1,6GLS 	11.05 » 09.11	545898G L 545899G R	545898 L 545899 R	JF		155890RG	155890R	SC
ACCENT IV								
(RB) 	11.10 »	545938G L 545939G R	545938 L 545939 R	JF		215919G	215919	SC
ELENTRA II								
	01.11 »	545991G L 545992G R	545991 L 545992 R	JF		115930G	115930	SC
EXCEL & PONY								
	77 » 84					114520G	114520	SC
(KMHL) 	85 » 08.89		444863	FU		114864G	114864	SC
(KMHU , KMHV) X2	09.89 » 07.94					114864G	114864	SC
GALLOPER								
	97 »	745476G	745476	PLL		715477G	715477	PLL
GETZ								
(TB) 	02 »					155760G	155760	SC
GRAND I 10								
	10.13 »	545996G L 545997G R	545996 L 545997 R	JF		155998G	155998	SC











MODELE MODEL	ANNEE / YEAR						
		AVANT / FRONT			ARRIÈRE / REAR		
		GAZ / GAS	HYD	TYPE	GAZ / GAS	HYD	TYPE
<b>H100</b>							
	07.93 » 10.04		245032	GC		204587	SC
<b>I 10</b>							
	01.04 » 02.11	545900G L 545011G R	545900 L 545011 R	JF	115905G	115905	SC
<b>I20</b>							
(PB, PBT) 1100 CC-U2, 1200 CC KAPPA 1400 CC GAMMA	03.12 »	545941G L 545942G R	545941 L 545942 R	JF	215919G	215919	SC
<b>IX35</b>							
(LM)  2.0, 2.0 CRDi Except (S)	10 »	545999G L 545990G R	545999 L 545990 R	JF	255901G	255901	SC GC
<b>S-COUPE</b>							
(S-COUPE) 	89 » 96				114864G	114864	SC
<b>SOLARIS IV</b>							
(RB) 	11.10 »	545938G L 545939G R	545938 L 545939 R	JF	215919G	215919	SC
<b>STELLAR</b>							
	83 » 86		204192	GC		111994	SC
	87 » 89					111994	SC
<b>TERRACAN</b>							
2.5 TD - 2.9 CRDI - 3.5 V6	01 » 08.04	745663G	745663	PLL	755664G	755664	PLL
2.9 CRDI	09.04 »	745663G	745663	PLL	755664G	755664	PLL
<b>VERNA II</b>							
 1,4 GL, 1,5 CRDi GLS, 1,6LS	11.05 »	545898G L 545899G R	545898 L 545899 R	JF	155890RG	155890R	SC
 1.4 GL, 1,5 CRDi GLs, 1,6 GLS	11.05 »	545898G L 545899G R	545898 L 545899 R	JF	155890RG	155890R	SC

## INNOCENTI

<b>90 - 120</b>							
L, SL Except 3 Cyl.	74 » 82		101495	SC		151495	SC
<b>A 40</b>							
MK II S, Spider S	62 » 67					171562	SC





MODELE MODEL	ANNEE / YEAR						
		AVANT / FRONT			ARRIÈRE / REAR		
		GAZ / GAS	HYD	TYPE	GAZ / GAS	HYD	TYPE
<b>MINI</b>							
 Except Mini De Tomaso, 3 Cyl.	60 »		101495	SC		151495	SC
Mini De Tomaso , Special Except 3 Cyl.	76 »		101495	SC		154655	SC
<b>ISUZU</b>							
<b>BELLET</b>							
D3, PR3, PR4	» 68		141537	SC		251078	GC
PR1, PR2, PR5, PR6, PR9	64 » 73		141537	SC			
<b>D.MAX</b>							
 2.5D, 3.0D	06.03 »	245012G	245012	GC	215013G	215013	GC
 2.5D , 3.0D (+) ressort/with spring	06.03 »	345014G	345014	SR	215015G	215015	GC
 2.5D, 3.0D (-) ressort/without spring	06.03 »	245012G	245012	GC	215013G	215013	GC
<b>ELF</b>							
(250) Series TL1, TL3	70 » 79	244861G	244861	GC			
(250) Series TL2	70 » 07.75	244861G	244861	GC			
(250) Series TL2 	08.75 » 79	244861G	244861	GC	104534G	104534	SC
(250) Series TL4, TL5, TL6 	70 » 79	244861G	244861	GC	211430G	211430	GC
<b>LIGHT ELF</b>							
KA 20, 40, 50	68 » 08.72	244861G	244861	GC	204587G	204587	GC
KA, KAD, KAG 40, 50	09.72 » 84	244861G	244861	GC			
<b>ELF FASTER</b>							
 Series KB, KBD 20, 30	72 » 81	144850G	144850	SC	204587G	204587	GC











MODELE MODEL	ANNEE / YEAR						
		AVANT / FRONT			ARRIÈRE / REAR		
		GAZ / GAS	HYD	TYPE	GAZ / GAS	HYD	TYPE
<b>ELF FASTER</b>							
 - Serie KBD 40	79 » 81	144850G	144850	SC			
<b>FASTER &amp; RODEO</b>							
KB 21, KB 26	80 » 86	148128G	148128	SC	114036G	114036	SC
<b>FLORIAN</b>							
(117)  PA1, PA2	67 » 68		141676	SC	251078G	251078	GC
(117)  PA2 - PA3 : 90, 95, 96	68 » 83		141676	SC			
<b>GEMINI</b>							
PF 50, PF 60, PFD 60, PT 60	74 » 84	144385G	144385	SC	154327G	154327	SC
<b>MIDI &amp; FARGO &amp; SETA</b>							
 WFR, 9800	80 »	144083G	144083	SC	214070G	214070	GC
 WFS, 9400	83 »				214070G	214070	GC
<b>PIAZZA</b>							
JR 120, JR 130	81 »	144385G	144385	SC			
<b>Pick up</b>							
 KB2, KBD2, KBG2	80 » 07.86	144850G	144850	SC			
 KB4, KBD4, KBG4	80 »	144850G	144850	SC			
 TFR	88 »	148128G	148128	SC	118129G	118129	SC
 TFR	88 »	148220G	148220	SC	118129G	118129	SC
<b>TROOPER &amp; BIG HORN</b>							
 UBS	81 » 10.86	144850G	144850	SC			
 UBS	01.92 »	745319G	745319	PLL	215322G	215322	GC





MODELE MODEL	ANNEE / YEAR						
		AVANT / FRONT			ARRIÈRE / REAR		
		GAZ / GAS	HYD	TYPE	GAZ / GAS	HYD	TYPE











## IVECO

IVECO DAILY (4x2)							
DAILY 4x2							
 28	78 » 05.89	204051G <sup>(1)</sup>	204051 <sup>(1)</sup>	GC	214052G <sup>(1)</sup>	214052 <sup>(1)</sup>	GC
 30.8:  → 304675	78 » 05.89	204051G <sup>(1)</sup>	204051 <sup>(1)</sup>	GC	214052G <sup>(1)</sup>	214052 <sup>(1)</sup>	GC
 35.8, 5.9, 35.10, 40.8, 40.10, 45.10, 49.10	78 » 05.89	204051G <sup>(1)</sup>	204051 <sup>(1)</sup>	GC	214052G <sup>(1)</sup>	214052 <sup>(1)</sup>	GC
 30.8:  304676 →	78 » 05.89	204908G <sup>(1)</sup>	204908 <sup>(1)</sup>	GC	214052G <sup>(1)</sup>	214052 <sup>(1)</sup>	GC
 30.8, 30.9	06.89 » 04.99	204908G <sup>(1)</sup>	204908 <sup>(1)</sup>	GC	214023G <sup>(1)</sup>	214023 <sup>(1)</sup>	GC
30.10, 35.8, 40.8, 40.10, 40.12	06.89 » 04.99	204969G <sup>(1)</sup>	204969 <sup>(1)</sup>	GC	214023G <sup>(1)</sup>	214023 <sup>(1)</sup>	GC
30.10, 5.8, 40.8, 40.10, 40.12	06.89 » 04.99	204908G <sup>(1)</sup>	204908 <sup>(1)</sup>	GC	214023G <sup>(1)</sup>	214023 <sup>(1)</sup>	GC
35.10, 45.10, 45.12, 49.10, 49.12	06.89 » 04.99	204969G <sup>(1)</sup> 204908G	204969 <sup>(1)</sup> 204908	GC	214994G	214994 <sup>(1)</sup>	GC
 40NC35	06.89 » 04.99	204051G <sup>(1)</sup>	204051 <sup>(1)</sup>	GC	214052G	214052 <sup>(1)</sup>	GC

## JAGUAR

E Type							
Except V12 4 Amortisseurs AR/4 Rear Shocks	61 » 75		201688	GC			
S Type							
3.4, 3.8 4 Amortisseurs AR/4 Rear Shocks	61 » 68		241756	GC		311757	SR
240 & 340							
2.4, 3.4, 3.8	60 » 69		241344	GC		271345	GC
MK II							
2.4, 3.4, 3.8	55 » 70		241344	GC		271345	GC
DAIMLER							
2.5	62 » 70		241344	GC		271345	GC
420							
420G - 420S 4 Amortisseurs AR/4 Rear Shocks	66 » 72		241756	GC		311757	SR





MODELE MODEL	ANNEE / YEAR						
		AVANT / FRONT			ARRIÈRE / REAR		
		GAZ / GAS	HYD	TYPE	GAZ / GAS	HYD	TYPE
<b>MK X</b>							
3.8 - 4.2 4 Amortisseurs AR/4 Rear Shocks	61 » 66		241756	GC		311757	SR
<b>DAIMLER SOVEREIGN</b>							
4 Amortisseurs AR/4 Rear Shocks	66 » 68		241756	GC		311757	SR
4 Amortisseurs AR/4 Rear Shocks	69 » 09.86		141822	SC		311823	SR
<b>XJ6</b>							
4 Amortisseurs AR/4 Rear Shocks	69 » 09.86		141822	SC		311823	SR
<b>XJ12</b>							
4 Amortisseurs AR/4 Rear Shocks	72 » 02.93		141822	SC		311823	SR
<b>DAIMLER DOUBLE SIX</b>							
4 Amortisseurs AR/4 Rear Shocks	72 » 02.93		141822	SC		311823	SR
<b>XJS - XJS.C</b>							
4 Amortisseurs AR/4 Rear Shocks	75 » 96		141822	SC		311823 <sup>(1)</sup>	SR
<b>JEEP</b>							
<b>CHEROKEE</b>							
 4x4	76 » 82	104770G		SC		114781	SC
<b>CHEROKEE &amp; WAGONEER</b>							
 4x4 XJ	83 » 90	244019G		GC		244019G	GC
 4x4 XJ : JB, JN	91 » 09.01	244019G		GC		214010	GC
<b>GRAND CHEROKEE &amp; GRAND WAGONEER</b>							
 4x4	83 » 91	104770G		SC		114781	SC
 4x4 Except 	92 » 93	244019G		GC			
<b>GRAND CHEROKEE</b>							
 4x4 ZJ : ZB, ZN Except 	94 » 98		744017	PLL		714018	PLL
<b>JENSEN</b>							
<b>INTERCEPTER</b>							
INTERCEPTER	69 » 76		241344	GC			
<b>HEALEY</b>							
HEALEY	73 » 76		101871	SC		151872	SC









KIA



LADA

MODELE MODEL	ANNEE / YEAR						
		AVANT / FRONT			ARRIÈRE / REAR		
		GAZ / GAS	HYD	TYPE	GAZ / GAS	HYD	TYPE











## KIA

<b>BESTA</b>							
	96 »	145127G	145127	SC	215321G	215321	GC
<b>CARNIVAL I &amp; II</b>							
CARNIVAL 1 (Up) CARNIVAL 2 (2.9 DTCi, CRDi)	99 » 05.06				255657G	255657	GC
<b>CERATO II / FORTE I</b>							
 1.6, 1.2	01.10 »	545917G L 545918G R	545917 L 545918 R	JF	215919G	215919	GC
<b>CERATO II</b>							
 1.6, 1.2	01.10 »	545917G L 545918G R	545917 L 545918 R	JF	215919G	215919	GC
<b>CERATO III / FORTE II</b>							
	08.12 »	545993G L 545994G R	545993 L 545994 R	JF	215995G	215995	GC
<b>PICANTO I</b>							
1.0, 1.1, 1.1 CRDi	01.04 » 04.11	545914G L 545915G R	545914 L 545915 R	JF	155854G	155854	SC
<b>PICANTO II</b>							
(TA) 1.0, 1.2	05.11 »	545926G L 545927G R	545926 L 545927 R	JF	155928G	155928	SC
<b>RIO II</b>							
 1.4, 1.6, 1.5D	03.05 » 07.11	545898G L 545899G R	545898 L 545899 R	JF	155890RG	155890R	SC
<b>RIO III</b>							
(UB) 	05.11 »	545938G L 545939G R	545938 L 545939 R	JF	115930G	115930	SC
<b>SPORTAGE</b>							
(SL)  2.0 CVVT, 2.0 CRDi Except (SS)	07.10 »	545999G L 545990G R	545999 L 545990 R	JF	255901G	255901	GC



## LADA

<b>110</b>							
2110 	95 »				354033G	354033	SR
<b>111</b>							
2111 	95 »				354033G	354033	SR

























MODELE MODEL	ANNEE / YEAR						
		AVANT / FRONT			ARRIÈRE / REAR		
		GAZ / GAS	HYD	TYPE	GAZ / GAS	HYD	TYPE
<b>112</b>							
2112 	95 »				354033G	354033	SR
<b>DIVA - FORMAN</b>							
2108, 2109, 2113, 2114, 2115	91 »	444032G	444032	FU	354033G	354033	SR
<b>KALINA</b>							
1119 	04 »				354033G	354033	SR
1118 	04 »				354033G	354033	SR
1117 	04 »				354033G	354033	SR
<b>KALINKA</b>							
2105, 2108, 2109	81 »		144259	SC		111867	SC
2104 	85 »		144259	SC		111867	SC
<b>LARGUS</b>							
BreaK/Estate MCV	12 »	545668G	545668	JF	155773G	155773	SC
<b>NATACHA &amp; RIVA &amp; SAGONA</b>							
2108, 2109, 2113, 2114, 2115	91 »	444032G <sup>(1)</sup>	444032 <sup>(1)</sup>	FU	354033G	354033	SR
<b>NIVA &amp; TAIGA</b>							
NIVA  TAIGA  2121, 2123	77 »	144592G	144592	SC	144593G	144593	SC
<b>SAMARA</b>							
2108, 2109, 2113, 2114, 2115	85 »	444032G <sup>(1)</sup>	444032 <sup>(1)</sup>	FU	354033G	354033	SR
<b>VAZ &amp; NOVA &amp; SHIGULI &amp; TOSCANA</b>							
  2101 → 2107	72 »	144592G	144592	SC		111867	SC

## LANCIA

<b>LANCIA A112</b>							
<b>A112</b>							
	80 »		544659	JF	554851G	554851	JF
<b>LANCIA BETA</b>							
<b>BETA I</b>							
 1300, 1400, 1600, 1800	72 » 75		444170 <sup>(1)</sup>	FU		454181 <sup>(1)</sup>	FU















MODELE MODEL	ANNEE / YEAR						
		AVANT / FRONT			ARRIÈRE / REAR		
		GAZ / GAS	HYD	TYPE	GAZ / GAS	HYD	TYPE
<b>BETA I</b>							
 1600, 1800	72 » 75		444733 <sup>(1)</sup>	FU		454477 <sup>(1)</sup>	FU
<b>BETA II &amp; III</b>							
 1300, 1600, 2000	75 » 84		444170 <sup>(1)</sup>	FU		454181 <sup>(1)</sup>	FU
 Spider 1300, 1600, 2000	75 » 84		444733 <sup>(1)</sup>	FU		454477 <sup>(1)</sup>	FU
<b>BETA</b>							
HPE Athena - 1600 - 2000	75 » 84		444733 <sup>(1)</sup>	FU		454181 <sup>(1)</sup>	FU
Monte-Carlo, Scorpion	76 » 84		444380 <sup>(1)</sup>	FU		454391 <sup>(1)</sup>	FU
<b>LANCIA DEDRA (4x2)</b>							
<b>DEDRA</b>							
(835)   1.6, Except Mpi	(2) 89 » 00	545216G	545216	JF	215160G	215160	GC
(835)   1.8, Except 132	(2) 89 » 00	545216G	545216	JF	215160G	215160	GC
(835)   1.9 TD	(2) 89 » 97	545216G	545216	JF	215160G	215160	GC
(835)   2.0	(2) 89 » 00	545216G	545216	JF	215160G	215160	GC
(835)   1.6 MPi 16 V	(2) 89 » 00				215160G	215160	GC
(835)   1.8 16V 132	(2) 89 » 00				215160G	215160	GC
(835)   1.9 TD	(2) 98 » 00				215160G	215160	GC
(835)   1.6, Except MPi	(2) 94 » 00	545216G	545216	JF	215598G	215598	GC
(835)   1.8, Except 132	(2) 94 » 00	545216G	545216	JF	215598G	215598	GC









MODELE MODEL	ANNEE / YEAR						
		AVANT / FRONT			ARRIÈRE / REAR		
		GAZ / GAS	HYD	TYPE	GAZ / GAS	HYD	TYPE
<b>DEDRA</b>							
(835)   1.9 TD	(2) 94 » 97	545216G	545216	JF	215598G	215598	GC
(835)   2.0	(2) 94 » 00	545216G	545216	JF	215598G	215598	GC
(835)   1.6 MPi 16 V	(2) 94 » 00				215598G	215598	GC
(835)   1.8 132 (16V)	(2) 94 » 00				215598G	215598	GC
(835)   1.9 TD	(2) 98 » 00				215598G	215598	GC
<b>LANCIA DELTA</b>							
<b>DELTA II</b>							
(836) 1.4, 1.6	(2) 09.93 » 00	545216G	545216	JF	114059G	114059	SC
(836) 1.8, 2.0 16V Except GT, HPE, Turbo HF	(2) 09.93 » 00	545216G	545216	JF	215160G	215160	GC
(836) 1.9 Turbo Diesel	(2) 09.93 » 00				215160G	215160	GC
(836) 2.0 16V: GT, HPE, Turbo HF	(2) 09.93 » 00				215160G	215160	GC
<b>DELTA III</b>							
(844) 	(2) 08 »	545624G	545624	JF	155625G	155625	SC
<b>LANCIA FLAVIA</b>							
<b>FLAVIA</b>							
  1300 C	63 » 72		141551	SC		111553	SC
  1500, 1800, 2000	62 » 05.67		141551	SC		111553	SC
  1500, 1800, 2000	06.67 » 75		101887	SC		111553	SC





MODELE MODEL	ANNEE / YEAR						
		AVANT / FRONT			ARRIÈRE / REAR		
		GAZ / GAS	HYD	TYPE	GAZ / GAS	HYD	TYPE
<b>LANCIA FLUVIA</b>							
<b>FULVIA</b>							
 Serie I	63 » 70		141551	SC		111553	SC
 Series II, III	71 » 75		141551	SC		114122	SC
<b>LANCIA MUSA</b>							
<b>MUSA</b>							
(350)  4x2	04 » 03.11	545599G	545599	JF	115590G	115590	SC
<b>LANCIA PHEDRA</b>							
<b>PHEDRA</b>							
(179) 	02 »	545676G L 545677G R	545676 L 545677 R	JF	215678G	215678	GC
<b>LANCIA THEMA Berline/Saloon , Break/Estate</b>							
<b>THEMA</b>							
(834)  Except Ferrari 8.32	(2) 84 » 10.86	545141G	545141	JF	(3) 555142G	(3) 555142	JF
(834)  Ferrari 8.32	(2) 11.86 » 95	545141G	545141	JF	(3) 555142G	(3) 555142	JF
<b>LANCIA TREVİ</b>							
<b>TREVİ</b>							
	80 » 84		444170 <sup>(1)</sup>	FU		454181 <sup>(1)</sup>	FU
<b>LANCIA Y10</b>							
<b>Y10</b>							
 4x2	85 » 12.92	544978G L 544979G R			114970G	114970	SC
 4x2	01.93 »	544978G L 544979G R			115257G	115257	SC
 4x4	85 » 12.92	544978G L 544979G R			114916G	114916	SC
<b>LANCIA Y YPSILON</b>							
<b>Y YPSILON I</b>							
(840) 	96 » 08.03	545285G	545285	JF	115286G	115286	SC



MODELE MODEL	ANNEE / YEAR						
		AVANT / FRONT			ARRIÈRE / REAR		
		GAZ / GAS	HYD	TYPE	GAZ / GAS	HYD	TYPE
<b>Y YPSILON II</b>							
(843)  Except Sport	09.03 » 04.11	545599G	545599	JF	115590G	115590	SC
<b>LANCIA ZETA</b>							
<b>ZETA</b>							
(220)   → 7609	94 » 08.97	545284G	545284	JF	215245G	215245	GC
(220)   7610 →	09.97 »	545284G	545284	JF	215468G	215468	GC





## LAND ROVER

<b>LAND ROVER 4x4</b>							
<b>DEFENDER I</b>							
90, 110, 130	83 » 09.02		860110	PL		834047 <sup>(1)</sup>	PL
<b>DEFENDER II</b>							
90, 110	10.02 » 12.06		860110	PL		834047 <sup>(1)</sup>	PL
<b>DISCOVERY I</b>							
LJ  → MA135957	89 » 05.94		860110	PL		830121	PL
LJ  MA135958 →	06.94 » 98		860110	PL			
<b>LAND ROVER</b>							
86 W.B. Conduite Tout Terrain/Off Road Driving	53 » 56		201478 704442	GC PLL		211430 814441	GC PL
88 W.B. Series I, II, III Conduite Tout Terrain/Off Road Driving	56 » 83		201478	GC		211430	GC
88 W.B. - Series I, II, III Conduite Tout Terrain/Off Road Driving	56 » 83		704442	PLL		814441	PL
107 W.B. Conduite Tout Terrain/Off Road Driving	53 » 58		201478 704442	GC PLL		211430 814441	GC PL
109 W.B. Series I Conduite Tout Terrain/Off Road Driving	53 » 58		201478 704442	PLL		211430 814441	GC PL
107 W.B. (Station Wagon) Conduite Tout Terrain/Off Road Driving	53 » 58		201478 704442	GC PLL		201478 704442	GC PLL
109 W.B. Series II, III	58 » 84		201478	GC		231479	GC
119 W.B.	58 » 84		201478	GC		231479	GC





LAND ROVER

MODELE MODEL	ANNEE / YEAR						
		AVANT / FRONT			ARRIÈRE / REAR		
		GAZ / GAS	HYD	TYPE	GAZ / GAS	HYD	TYPE
<b>LAND ROVER</b>							
109 W.B. (Series II,III) , 119 W.B. Conduite Tout Terrain/Off Road Driving	58 » 84		704442	PLL		834443	PLL
FC 109	63 » 84		201891	GC		231892	GC
90, 110, 130	83 » 00		860110	PL		834047 <sup>(1)</sup>	PL
<b>RANGE ROVER</b>							
(LH) 100 WB Except 	70 »		860110	PL		830121	PL
(LP) 100 WB 	10.94 » 01.02		825480	PL		835491	PL
CLASSIC Except 	94 » 01.02		860110	PL		830121	PL
<b>SANTANA</b>							
88 Made in ESP. Conduite Tout Terrain/Off Road Driving			201478 704442	GC PLL		814441	GC PL
109 , 119 - Made in ESP. Conduite Tout Terrain/Off Road Driving			201478 704442	GC PLL		231479 834443	GC PLL

MAHINDRA

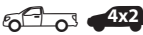
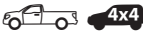

## MAHINDRA

<b>SCORPIO</b>							
(SC) (DC)  2.5 L	06 »	145986G	145986	SC	715987G	715987	GC
(SC) (DC)  2.5 L	06 »	145986G	145986	SC	715988G	715988	PLL







## MATRA

<b>530</b>							
LX, SX, XL	68 »		101766	SC		111767	SC
<b>BAGHEERA</b>							
	73 » 81		144287	SC		114288	SC
<b>JET V &amp; VS</b>							
4 Amortisseurs à l'arrière/4 Shocks on the Rear	64 » 68		141118	SC		141112	SC



MODELE MODEL	ANNEE / YEAR						
		AVANT / FRONT			ARRIÈRE / REAR		
		GAZ / GAS	HYD	TYPE	GAZ / GAS	HYD	TYPE
<b>JET VI</b>							
4 Amortisseurs à l'arrière/4 Shocks on the Rear	64 » 68		141118	SC		141112	SC
<b>MURENA</b>							
1.6	80 »		145185	SC			
2.2	80 »		145185	SC			
<b>RANCHO</b>							
	77 »		144345 <sup>(1)</sup>	SC	154528G	154528	SC

## MAZDA

<b>MAZDA 2 --&gt; 6</b>							
<b>II</b>							
DY 	03 » 08.07	545641G L 545642G R	545641 L 545642 R	JF	155643G	155643	SC
DE 	09.07 » 10.14				155707G	155707	SC
<b>III</b>							
BK  Except MPS	03 » 04.09	545681G L 545682G R	545681 L 545682 R	JF	155683G	155683	SC
BL 	05.09 » 08.13	545681G L 545682G R	545681 L 545682 R	JF			
<b>MAZDA 121 --&gt; 929</b>							
<b>121</b>							
Cosmo 1800, RX5 Rotary 	75 » 87		444695	FU		154696	SC
Made in Europe (JAS, JBS, JVS) Essence/Petrol	96 » 09.98	545328G	545328	JF	355320G	355320	SR
Made in Europe (JAS, JBS, JVS) Essence/Petrol	10.98 »	545328G	545328	JF	355479G	355479	SR
Made in Europe (JAS, JBS, JVS) Diesel	96 » 09.98	545329G	545329	JF	355320G	355320	SR
Made in Europe (JAS, JBS, JVS) Diesel	10.98 »	545329G	545329	JF	355479G	355479	SR
<b>323</b>							
 1000 → 1400 Propulsion/RWD FA 4 PS :  → 532270	77 » 05.79		444355	FU		114517	SC





















MODELE MODEL	ANNEE / YEAR						
		AVANT / FRONT			ARRIÈRE / REAR		
		GAZ / GAS	HYD	TYPE	GAZ / GAS	HYD	TYPE
<b>323</b>							
 1000 → 1400 Propulsion/RWD FA 4 TS :  → 781083	77 » 05.79		444355	FU		114517	SC
 1000 → 1400 Propulsion/RWD FA 4 US :  → 574839	77 » 05.79		444355	FU		114517	SC
 1000 → 1400 Propulsion/RWD FA 4 PS :  532271 →	06.79 » 05.80		444840	FU		114517	SC
 1000 → 1400 Propulsion/RWD FA 4 TS :  781084 →	06.79 » 05.80		444840	FU		114517	SC
 1000 → 1400 Propulsion/RWD FA 4 US :  574840 →	06.79 » 05.80		444840	FU		114517	SC
 1300 → 1400 Propulsion/RWD FA 4 TV :  → 504906	78 » 05.79		444355	FU		174762	SC
 1300 → 1400 Propulsion/RWD FA 4 UV :  → 528946	78 » 05.79		444355	FU		174762	SC
 1300 → 1400 Propulsion/RWD FA 4 TV :  504907 →	06.79 » 10.85		444840	FU		174762	SC
 1300 → 1400 Propulsion/RWD FA 4 UV :  528947 →	06.79 » 10.85		444840	FU		174762	SC
 1300 → 1400 Propulsion/RWD FA 4 T6	06.79 » 10.85		444840	FU		174762	SC



MODELE MODEL	ANNEE / YEAR						
		AVANT / FRONT			ARRIÈRE / REAR		
		GAZ / GAS	HYD	TYPE	GAZ / GAS	HYD	TYPE
<b>616</b>							
 RX2 inclus CB1 (MN, MU, SN, SU)	70 » 09.78		441874	FU			
<b>616 &amp; 626</b>							
  (1) Capella, Montrose CB 2 MS :  → 543879	10.78 » 09.79		444606	FU		154607	SC
  (1) Capella, Montrose B 2 NS :  → 525068	10.78 » 09.79		444606	FU		154607	SC
  (1) Capella, Montrose CB 2 VS , XB 2 VS :  → 502902	10.78 » 09.79		444606	FU		154607	SC
  (1) Capella, Montrose CB 2 MS :  543880 →	10.79 » 08.82		444882	FU		154607	SC
  (1) Capella, Montrose CB 2 NS :  525069 →	10.79 » 08.82		444882	FU		154607	SC
  (1) Capella, Montrose CB, XB 2 VS :  502903 →	10.79 » 08.82		444882	FU		154607	SC
  (1) Capella, Montrose GB1	10.79 » 08.82		444882	FU		154607	SC
<b>818</b>							
  1300, 1600 - Savanna (S124A)	71 » 78		444355	FU		154356	SC
  RX3 Rotary	71 » 78		444355	FU		154356	SC
 /Station Wagon (S124W)	71 » 78		444355	FU		164350	SC
<b>929</b>							
Luce   (1) (Series LA2, LA22, LA3, LA33) RX4 Rotary	72 » 09.77		444361	FU		174762	SC
 LA2V, LA3V, LA33W	72 » 78		444361	FU		174362	SC
<b>929 L</b>							
Luce, Legato   (1) (Series LA4, LA43)	10.77 » 08.79		444748	FU		154607	SC











MODELE MODEL	ANNEE / YEAR						
		AVANT / FRONT			ARRIÈRE / REAR		
		GAZ / GAS	HYD	TYPE	GAZ / GAS	HYD	TYPE
<b>929 L</b>							
Legato  (Series LA4, LA43)	09.79 » 09.81		444896	FU		154607	SC
 LA4V, LA4MV	78 » 80		444748	FU		174750	SC
Legato  LA4SV	81 » 85		444896	FU		174750	SC
<b>MAZDA 1000 --&gt; 1800</b>							
<b>1000 -1200 - 1300</b>							
 1000	68 » 77		441874	FU		174358	SC
<b>1300</b>							
 1300	70 » 77		441874	FU			
<b>1500 - 1800</b>							
 1500	66 » 72		141839	SC		174358	SC
<b>MAZDA A --&gt; Z</b>							
<b>B</b>							
 1600 BNA, PROCEED	70 » 82		144357	SC		174358	SC
 B 1600, B 1800, B 2000	70 » 85		144357	SC		174358	SC
(UF)   B 1600 → B 2600	85 » 03.99		145022			204587	GC
  B 2200, B 2500, B 2900	04.99 »	245010G	245010	GC	215021G	215021	GC
  B 2200, B 2500, B 2600	03.87 » 11.06	745033G	745033	PLL	715034G	715034	PLL
<b>BT50</b>							
Series 1  , 	07 »	745033G	745033	PLL	715034G	715034	PLL
<b>E</b>							
 1600 (BA2 , N9), BONGO	78 » 84		144702	SC		114703	SC
 E 2200	78 » 84		144702	SC		204587	GC



















MODELE MODEL	ANNEE / YEAR						
		AVANT / FRONT			ARRIÈRE / REAR		
		GAZ / GAS	HYD	TYPE	GAZ / GAS	HYD	TYPE
<b>E</b>							
(SR)  E 1400 → E 2200 	84 » 96		145127	SC	118668G	118668	SC
(SR)  E 1400 → E 2200 	84 » 96		145127	SC		204587	GC
(SR)   E 2000, E 2200	97 »		145127	SC	118668G	118668	SC
(SR)  E 1400, E 1800, E 2000, E 2200	84 »		145127	SC			
 1600 (BA2 , N9)	78 » 84		144702	SC		114703	SC
(SD)   E 1400 → E 2200	84 » 96		145127	SC		204587	GC
(SD)    E 2000, E 2200 	97 » 08.99		145127	SC			
(SD)    E 2000, E 2200 	97 » 08.99		145127	SC	215494G	215494	GC
(SD)    E 2000, E 2200 	97 » 08.99				215494G	215494	GC
<b>FAMILIA</b>							
(SP, ST)  (Presto inclus)	68 » 77		441874	FU		174750	SC
<b>RX2</b>							
Capella , Rotary	70 » 78		441874	FU			
<b>RX3</b>							
Rotary, Savanna 808  	71 » 78		444355	FU		154356	SC



MODELE MODEL	ANNEE / YEAR						
		AVANT / FRONT			ARRIÈRE / REAR		
		GAZ / GAS	HYD	TYPE	GAZ / GAS	HYD	TYPE
<b>RX4</b>							
Rotary  (Series : LA2, LA3)	72 » 77		444361	FU		174362	SC
<b>RX5</b>							
Rotary 	75 » 87		444695	FU		154696	SC
<b>RX7</b>							
Savanna - SA 22 C Rotary   → 575603	78 » 11.80		444758	FU		154759	SC
Savanna - SA 22 C Rotary   575604 →	12.80 » 85					154759	SC

## MERCEDES

### MERCEDES BENZ 190 --> 220 : Berline/Saloon & Coupé & Cabriolet













<b>190</b>							
(W 110)    190C, 190DC	61 » 67		141697	SC		<sup>(2) (3)</sup> 251698	GC
(W 201)    190, 190E, 190D Except Sportline, 16V	83 » 93	544932G	544932	JF	<sup>(2)</sup> 154933G	<sup>(2)</sup> 154933	SC
<b>200</b>							
(W 110)    200, 200D	65 » 67		141697	SC		<sup>(2) (3)</sup> 251698	GC
(W 124)    200, 200D, 200 E Except Sportline, 4Matic	84 » 93	544976G	544976	JF	<sup>(2)</sup> 154933G	<sup>(2)</sup> 154933	SC
<b>220</b>							
(W 110)    220B, 220SB, 220SE, 220SEB	60 » 67		141697	SC		<sup>(2) (3)</sup> 251698	GC
 220D Long Limousine	68 » 79	141884G	141884	SC	<sup>(2) (3)</sup>	<sup>(2) (3)</sup>	



MODELE MODEL	ANNEE / YEAR						
		AVANT / FRONT			ARRIÈRE / REAR		
		GAZ / GAS	HYD	TYPE	GAZ / GAS	HYD	TYPE
<b>200 &amp; 220</b>							
(W 115)  200, 200D, 220, 220D Except Long Lim.	68 » 02.76	141884G	141884	SC	<sup>(2)</sup> 254398G	<sup>(2)</sup> 254398	GC
(W 123)  200, 200D, 220, 220D Except Long Lim.	03.76 » 84	144260G	144260	SC	<sup>(2)</sup> 254398G	<sup>(2)</sup> 254398	GC
(C 124)  200 CE, 220 CE Except Sportline	87 » 93	544976G	544976	JF	<sup>(2)</sup> 154933G	<sup>(2)</sup> 154933	SC
<b>MERCEDES BENZ 230 --&gt; 250 : Berline/Saloon &amp; Coupé &amp; Cabriolet</b>							
<b>230 , 250</b>							
(W 108, W 111)  230, 230S 230SL, 250S, 250SE	65 » 72		141697	SC		<sup>(2) (3)</sup> 251698	GC
<b>250</b>							
(W 108, W 111)  250SL	67 » 81		141697	SC		<sup>(2) (3)</sup> 251698	GC
(W 114, W115)  250, 250C, 250CE	73 » 02.76		141884	SC	<sup>(2)</sup> 254398G	<sup>(2)</sup> 254398	GC
(W 123)  250, 250C, 250CE, 250E	03.76 » 84		144260	SC	<sup>(2)</sup> 254398G	<sup>(2)</sup> 254398	GC
(W 124)  250D, 250D Turb Except Sportline, 4Matic	84 » 93	544976G	544976	JF	<sup>(2)</sup> 154933G	<sup>(2)</sup> 154933	SC
<b>230</b>							
(W 115)  230/4, 230/6	68 » 76		141884	SC	<sup>(2)</sup> 254398G	<sup>(2)</sup> 254398	GC
(W 123, C123)  230, 230C, 230CE, 230E	76 » 84		144260	SC	<sup>(2)</sup> 254398G	<sup>(2)</sup> 254398	GC

















MODELE MODEL	ANNEE / YEAR						
		AVANT / FRONT			ARRIÈRE / REAR		
		GAZ / GAS	HYD	TYPE	GAZ / GAS	HYD	TYPE
<b>230</b>							
(W 124)  230E Except Sportline, 4Matic	84 » 93	544976G	544976	JF	(2) 154933G	(2) 154933	SC
(C 124)  230CE Except Sportline	87 » 93	544976G	544976	JF	(2) 154933G	(2) 154933	SC
(C 124)  230CE Except Sportline	90 » 93				(2) 154933G	(2) 154933	SC
<b>240</b>							
(W 115)  240D (3.0 inclus) Except Long Limousine	73 » 76		141884	SC	(2) 254398G	(2) 254398	GC
(W 123)  240D Except Long Limousine	76 » 84		144260	SC	(2) 254398G	(2) 254398	GC
 240D, Long Limousine	68 » 79	141884G	141884	SC			
<b>MERCEDES BENZ 260 --&gt; 280 : Berline/Saloon &amp; Coupé &amp; Cabriolet</b>							
<b>260</b>							
(W 124)  260E Except Sportline, 4 Matic	84 » 93	544976G	544976	JF	(2) 154933G	(2) 154933	SC
(W 126)  260SE	85 » 91	144260G	144260	SC	(2) 254398G	(2) 254398	GC
<b>280</b>							
(W 108)  280S, 280SE, 280SEL	68 » 08.72		141697	SC	(2) (3) 251698G	(2) (3) 251698	GC
(W108)  280SL	68 » 71		141697	SC	(2) (3) 251698G	(2) (3) 251698	GC
(W 114, 115)  280, 280C, 280CE, 280E	73 » 02.76	141884G	141884	SC	(2) (3) 251698G	(2) (3) 251698	GC



MODELE MODEL	ANNEE / YEAR						
		AVANT / FRONT			ARRIÈRE / REAR		
		GAZ / GAS	HYD	TYPE	GAZ / GAS	HYD	TYPE
<b>280</b>							
(W 123 , C 123)  280, 280C, 280CE, 280E	03.76 » 84	144260G	144260	SC	<sup>(2) (3)</sup> 251698G	<sup>(2) (3)</sup> 251698	GC
(W 116)  280S, 280SE, 280SEL	09.72 » 80	144260G	144260	SC	<sup>(2) (3)</sup> 251698G	<sup>(2) (3)</sup> 251698	GC
(W 126)  280S, 280SE, 280SEL	80 » 85	144260G	144260	SC	<sup>(2) (3)</sup> 251698G	<sup>(2) (3)</sup> 251698	GC
(W 107, C107, R107)  280SL, 280SLC	72 » 85	141884G	141884	SC	<sup>(2) (3)</sup> 251698G	<sup>(2) (3)</sup> 251698	GC
(W 124)  280E Except Sportline, 4Matic	85 » 93	544976G	544976	JF	<sup>(2)</sup> 154933G	<sup>(2)</sup> 154933	SC
<b>MERCEDES BENZ 300 --&gt; 320 : Berline/Saloon &amp; Coupé &amp; Cabriolet</b>							
<b>300</b>							
(W 108)  300SE, SE/A, SE/C Except 	62 » 67		141697	SC	<sup>(2) (3)</sup> 251698G	<sup>(2) (3)</sup> 251698	GC
(W 108)  300SEB, 300SEL Except 	65 » 67		141697	SC	<sup>(2) (3)</sup> 251698G	<sup>(2) (3)</sup> 251698	GC
(W 108)  300SE, 300SEL 	62 » 67		141910	SC	<sup>(2) (3)</sup> 251698G	<sup>(2) (3)</sup> 251698	GC
(W 107, C107, R107)  300D	75 » 02.76	141884G	141884	SC	<sup>(2) (3)</sup> 251698G	<sup>(2) (3)</sup> 251698	GC
(W 107, C107, R107)  300SL	85 » 89	141884G	141884	SC	<sup>(2) (3)</sup> 251698G	<sup>(2) (3)</sup> 251698	GC
(W 123)  300D, 300D Turbo, 300CD, 300CD Turbo	03.76 » 84	144260G	144260	SC	<sup>(2) (3)</sup> 251698G	<sup>(2) (3)</sup> 251698	GC





MODELE MODEL	ANNEE / YEAR						
		AVANT / FRONT			ARRIÈRE / REAR		
		GAZ / GAS	HYD	TYPE	GAZ / GAS	HYD	TYPE
<b>300</b>							
(W 126)  300SE, 300SEL, 300SD Turbo	80 » 91	144260G	144260	SC	<sup>(2) (3)</sup> 251698G	<sup>(2) (3)</sup> 251698	GC
(W 124)  300D, 300D Turbo, 300E Except Sportline, 4Matic	84 » 93	544976G	544976	JF	<sup>(2)</sup> 154933G	<sup>(2)</sup> 154933	SC
(C 124)  300CE Except Sportline	87 » 93	544976G	544976	JF	<sup>(2)</sup> 154933G	<sup>(2)</sup> 154933	SC
(A 124)  300CE Except Sportline	90 » 93				<sup>(2)</sup> 154933G	<sup>(2)</sup> 154933	SC
<b>320</b>							
(W 124)  320E, Except Sportline, 4Matic	84 » 93	544976G	544976	JF	<sup>(2)</sup> 154933G	<sup>(2)</sup> 154933	SC
(C 124)  320CE Except Sportline	87 » 93	544976G	544976	JF	<sup>(2)</sup> 154933G	<sup>(2)</sup> 154933	SC
(A 124)  320 CE Except Sportline	90 » 93				<sup>(2)</sup> 154933G	<sup>(2)</sup> 154933	SC
<b>MERCEDES BENZ 350 --&gt; 450 : Berline/Saloon &amp; Coupé &amp; Cabriolet</b>							
<b>350 &amp; 450</b>							
(W 116)  350SE, SEL, 450SE, SEL	71 » 80	144260G	144260	SC	<sup>(2)</sup> 254398G	<sup>(2)</sup> 254398	GC
(W 107, C107, R107)  350SL, SLC, 450SL, SLC	71 » 81	141884G	141884	SC	<sup>(2)</sup> 254398G	<sup>(2)</sup> 254398	GC
<b>380</b>							
(W 126, C 126)  380SE, SEC, SEL	80 » 85	144260G	144260	SC	<sup>(2)</sup> 254398G	<sup>(2)</sup> 254398	GC
<b>380 &amp; 420</b>							
(W 107, C107, R107)  380SL, 420SL	80 » 89	141884G	141884	SC	<sup>(2)</sup> 254398G	<sup>(2)</sup> 254398	GC













MODELE MODEL	ANNEE / YEAR						
		AVANT / FRONT			ARRIÈRE / REAR		
		GAZ / GAS	HYD	TYPE	GAZ / GAS	HYD	TYPE
<b>380 &amp; 420</b>							
(W 107, C107, R107)  380SLC	81 » 92	144260G	144260	SC	<sup>(2)</sup> 254398G	<sup>(2)</sup> 254398	GC
<b>420</b>							
(W 126, C 126)  420SE, SEC, SEL	85 » 92	144260G	144260	SC	<sup>(2)</sup> 254398G	<sup>(2)</sup> 254398	GC
<b>400</b>							
(W 124)  400E Except Sportline, 4 Matic	84 » 93	544976G	544976	JF	<sup>(2)</sup> 154933G	<sup>(2)</sup> 154933	SC
<b>MERCEDES BENZ 500 --&gt; 600 : Berline/Saloon &amp; Coupé &amp; Cabriolet</b>							
<b>500</b>							
(W 126, C126)  500SE, SEC, SEL	80 » 92	144260G	144260	SC	<sup>(2)</sup> 254398G	<sup>(2)</sup> 254398	GC
(W 107, C107, R107)  500SLC	81 » 92	144260G	144260	SC	<sup>(2)</sup> 254398G	<sup>(2)</sup> 254398	GC
(W 107)  500SL	80 » 89	141884G	141884	SC	<sup>(2)</sup> 254398G	<sup>(2)</sup> 254398	GC
(W 124)  500E	<sup>(1)</sup> 91 » 93	544976G	544976	JF			
<b>560</b>							
(W 126, C126)  560SE, SEC, SEL	85 » 92	144260G	144260	SC	<sup>(2)</sup> 254398G	<sup>(2)</sup> 254398	GC
<b>MERCEDES BENZ 190 --&gt; 320 : Break/Estate &amp; Ambulance</b>							
<b>190 &amp; 200</b>							
(W 110, W111)  190C, DC, 200, 200D	61 » 67		141697	SC		<sup>(2)</sup> 251710	GC
<b>220 &amp; 230</b>							
(W 111)  220B, SB, 230, 230S	61 » 67		141697	SC		<sup>(2)</sup> 251710	GC















MODELE MODEL	ANNEE / YEAR						
		AVANT / FRONT			ARRIÈRE / REAR		
		GAZ / GAS	HYD	TYPE	GAZ / GAS	HYD	TYPE
<b>220</b>							
(W 115)  220, 220D	68 » 78	141884G	141884	SC	<sup>(2)</sup> 254398G	<sup>(2)</sup> 254398	GC
<b>230 &amp; 240</b>							
(W 115)  230/4, 240D	73 » 78	141884G	141884	SC	<sup>(2)</sup> 254398G	<sup>(2)</sup> 254398	GC
<b>200 --&gt; 240</b>							
(W 123)  200T, 230T, 230TE, 240TD	78 » 85	144260G	144260	SC			
<b>250 --&gt; 300</b>							
(W 123)  250T, 280TE, 300TD, 300TD Turbo	78 » 85	144260G	144260	SC			
<b>200 &amp; 230</b>							
(W 124)  200TE, TD, 220TE, 230TE Except Sportline, 4Matic	85 » 93	544976G	544976	JF			
<b>250 &amp; 280</b>							
(W 124)  250TD, 260TE, 280TE Except Sportline, 4Matic	85 » 93	544976G	544976	JF			
<b>300 &amp; 320</b>							
(W 124)  300TD Turbo, TE, 320TE Except Sportline, 4Matic	85 » 93	544976G	544976	JF			
<b>MERCEDES BENZ "A" KLASSE</b>							
<b>"A" KLASSE</b>							
(W 168)  Phase 1 - A 140 → A 190	97 » 02.01	545549G	545549	JF	115539G	115539	SC
(W 168)  Phase 2 - A 140 → A 210 Court/SWB (360), Family/Long/LWB (377)	03.01 » 08.04	545549G	545549	JF	115539G	115539	SC







MODELE MODEL	ANNEE / YEAR						
		AVANT / FRONT			ARRIÈRE / REAR		
		GAZ / GAS	HYD	TYPE	GAZ / GAS	HYD	TYPE
<b>"A" KLASSE</b>							
(W169)  A 150 → A 200 Except (SS) 	09.04 » 08.12	545701G	545701	JF	155740G	155740	SC
<b>MERCEDES BENZ "B" KLASSE</b>							
<b>"B" KLASSE</b>							
(W245) B150 → B200 Except (SS)	05 » 10.11	545702G	545702	JF	155740G	155740	SC
<b>MERCEDES BENZ "C" KLASSE : Berline/Saloon &amp; Coupé</b>							
<b>"C" KLASSE</b>							
(W 202) <sup>(1)</sup>  C180 → C280 Except C36 AMG , C43 AMG, Esprit, (SS)	93 » 04.00	145308G <sup>(4)</sup>		SC	155309G		SC
<b>MERCEDES BENZ "C" KLASSE : Break/Estate &amp; Ambulance</b>							
<b>"C" KLASSE</b>							
(S202, T202) <sup>(1)</sup>  C180 → C280 Except C43 AMG, Esprit, (SS)	96 » 02.01	145308G <sup>(4)</sup>		SC			
<b>MERCEDES BENZ CITAN</b>							
<b>CITAN</b>							
(415) 	12 »	545672G <sup>(5)</sup> 545846G	545672 <sup>(5)</sup> 545846	JF	215763G	215763	GC
<b>MERCEDES BENZ "E" KLASSE : Berline/Saloon &amp; Coupé &amp; Cabriolet</b>							
<b>E200 &amp; E200D &amp; E220</b>							
(W 124) <sup>(1)</sup>  Except Sportline, 4Matic	92 » 05.95	544976G <sup>(4)</sup>	544976 <sup>(4)</sup>	JF	154933G <sup>(2) (4)</sup>	154933 <sup>(2) (4)</sup>	SC
<b>E220 CE</b>							
(C 124) <sup>(1)</sup>  Except Sportline	92 » 05.95	544976G <sup>(4)</sup>	544976 <sup>(4)</sup>	JF	154933G <sup>(2) (4)</sup>	154933 <sup>(2) (4)</sup>	SC
<b>E200 &amp; E220</b>							
(A 124) <sup>(1)</sup>  Except Sportline	92 » 98				154933G <sup>(2)</sup>	154933 <sup>(2)</sup>	SC



MODELE MODEL	ANNEE / YEAR							
		AVANT / FRONT			ARRIÈRE / REAR			
		GAZ / GAS	HYD	TYPE	GAZ / GAS	HYD	TYPE	
<b>E200 &amp; E200D &amp; E200 CDI E220D &amp; E220 CDI</b>								
(W 210)  Except Avantgarde (SS) 4Matic	(1) 06.95 » 02.02	145300G			SC	155411G		SC
(W 210)  (+) Avantgarde	(1) 06.95 » 02.02	145694G			SC	155695G		SC
<b>E230 &amp; E240</b>								
(W 210)  Except Avantgarde (SS)	(1) 95 » 02.02	145300G			SC	155411G		SC
(W 210)  (+) Avantgarde	(1) 95 » 02.02	145694G			SC	155695G		SC
<b>E250D &amp; E250TD</b>								
(W 124)  Except (SS), 4Matic, Long Véhicule	(1) 92 » 05.95	544976G	544976	JF		(2) 154933G	(2) 154933	SC
(W 210)  Except Avantgarde, (SS)	(1) 06.95 » 02.02	145300G			SC	155411G		SC
(W 210)  (+) Avantgarde	(1) 06.95 » 02.02	145694G			SC	155695G		SC
<b>E250D</b>								
(V 124)  Long Véhicule	(1) 92 » 05.95	544976G	544976	JF				
<b>E270 CDI</b>								
(W 210)  Except Avantgarde, (SS), 4Matic	(1) 99 » 02.02	145300G			SC	155411G		SC
(W 210)  (+) Avantgarde	(1) 99 » 02.02	145694G			SC	155695G		SC
<b>E280</b>								
(W 124)  Except (SS), 4Matic, Long Véhicule	(1) 92 » 05.95	544976G	544976	JF		(2) 154933G	(2) 154933	SC







MODELE MODEL	ANNEE / YEAR						
		AVANT / FRONT			ARRIÈRE / REAR		
		GAZ / GAS	HYD	TYPE	GAZ / GAS	HYD	TYPE
<b>E280</b>							
(V 124)  Long Véhicule	<sup>(1)</sup> 92 » 05.95	544976G	544976	JF			
(W 210)  Except Avantgarde, (SS), 4Matic	<sup>(1)</sup> 06.95 » 02.02	145300G		SC	155411G		SC
(W 210)  (+) Avantgarde	<sup>(1)</sup> 06.95 » 02.02	145694G		SC	155695G		SC
<b>E290 TD</b>							
(W 210)  Except Avantgarde (SS)	<sup>(1)</sup> 95 » 02.02	145300G		SC	155411G		SC
(W 210)  Avantgarde	<sup>(1)</sup> 95 » 02.02	145694G		SC	155695G		SC
<b>E300D &amp; E300TD</b>							
(W 124)  Except Sportline, 4 Matic	<sup>(1)</sup> 92 » 05.95	544976G	544976	JF	<sup>(2)</sup> 154933G	<sup>(2)</sup> 154933	SC
(W 210)  Except Avantgarde, (SS)	<sup>(1)</sup> 06.95 » 02.02	145300G		SC	155411G		SC
(W 210)  (+) Avantgarde	<sup>(1)</sup> 06.95 » 02.02	145694G		SC	155695G		SC
<b>E300 &amp; 300CE</b>							
(A 124)  Except Sportline	<sup>(1)</sup> 92 » 98				<sup>(2)</sup> 154933G	<sup>(2)</sup> 154933	SC
<b>E320</b>							
(W 124)  Except Sportline, 4Matic	<sup>(1)</sup> 92 » 05.95	544976G	544976	JF	<sup>(2)</sup> 154933G	<sup>(2)</sup> 154933	SC
(W210)  Except Avantgarde, (SS), 4Matic	<sup>(1)</sup> 06.95 » 02.02	145300G		SC	155411G		SC
(W 210)  (+) Avantgarde	<sup>(1)</sup> 06.95 » 02.02	145694G		SC	155695G		SC













MODELE MODEL	ANNEE / YEAR						
		AVANT / FRONT			ARRIÈRE / REAR		
		GAZ / GAS	HYD	TYPE	GAZ / GAS	HYD	TYPE
<b>E320</b>							
(A 124)  Except Sportline	(1) 92 » 98				(2) 154933G	(2) 154933	SC
<b>E320Cdi</b>							
(W210)  Except Avantgarde, (S), 4Matic	(1) 99 » 02.02	145300G		SC	155411G		SC
(W 210)  (+) Avantgarde	(1) 99 » 02.02	145694G		SC	155695G		SC
<b>E320 CE</b>							
(C 124)  Except Sportline	(1) 92 » 05.95	544976G	544976	JF	(2) 154933G	(2) 154933	SC
<b>E400 &amp; E420</b>							
(W 124)  Except Sportline, 4Matic	(1) 92 » 05.95	544976G	544976	JF	(2) 154933G	(2) 154933	SC
<b>E420 &amp; E430</b>							
(W 210)  Except Avantgarde, (S), 4Matic	(1) 06.95 » 02.02	145300G		SC	155411G		SC
(W 210)  (+) Avantgarde	(1) 06.95 » 02.02	145694G		SC	155695G		SC
<b>E500</b>							
(W 124)  	(1) 92 » 95	544976G	544976	JF			
<b>E50 AMG &amp; E55 AMG</b>							
(W 210)  Except Avantgarde, (S)	(1) 95 » 02.02	145300G		SC	155411G		SC
(W 210)  (+) Avantgarde	(1) 95 » 02.02	145694G		SC	155695G		SC



MODELE MODEL	ANNEE / YEAR						
		AVANT / FRONT			ARRIÈRE / REAR		
		GAZ / GAS	HYD	TYPE	GAZ / GAS	HYD	TYPE
<b>MERCEDES BENZ "E" KLASSE : Break/Estate &amp; Ambulance</b>							
<b>"E" KLASSE</b>							
(S 124) E200, E220, E220 Cdi, E250D, E250TD, E280, E300, E300D, E300TD, E320 Except Sportline, 4Matic	(1) 92 » 05.96	544976G	544976	JF			
(S 210) E200, E220D, E220 Cdi, E230, E240, E250D, E250TD, E270 Cdi, E280, E290TD, E300TD, E320, E320Cdi, E420, E430 Except Avantgarde, Long, 	(1) 06.96 » 12.02	145300G		SC			
(S210, T210) E200 > E430 (+) Avantgarde Except Long	(1) 06.96 » 12.02	145694G		SC			
<b>MERCEDES BENZ "G" KLASSE 4x4</b>							
<b>"G" KLASSE</b>							
(W 460) 200G, 200GE, 230G, 230GE, 240GD, 250GD, 280GE, 300GD	79 » 01.90		724866	PLL		754867	PLL
(W 461) 200GE, 230GE, 250GD, 290GD, 300GD, 300GE, 300TD, 320, 300GD, 350TD Turbo, 500GE	02.90 » 08.93		725333	PLL		755334	PLL
(W 463) G230, G270 CDi, G290D, G300, G300D, G300TD, G320, G350 TD, G400 CDi, G500, G55KAMG	09.93 » 04.08		725333	PLL		755334	PLL
<b>MERCEDES BENZ "V" KLASSE</b>							
<b>"V" KLASSE</b>							
V220 → V280	96 » 03	545519G	545519	JF	115510G	115510	SC
<b>MERCEDES BENZ UTILITAIRES / COMMERCIALS</b>							
<b>"L" SERIES</b>							
(Type 605 , 606) L206D - L306D  AR/Rear Torsion Bar	72 »		201092	GC			
(Type 607, 608) L206D, DG, L306D, DG  AR/Rear	73 »		201092	GC		114381	SC







MODELE MODEL	ANNEE / YEAR						
		AVANT / FRONT			ARRIÈRE / REAR		
		GAZ / GAS	HYD	TYPE	GAZ / GAS	HYD	TYPE
<b>"L" SERIES</b>							
(Type 605, 606) L207, L307  AR/Rear			201092	GC		114381	SC
(Type 601) L207D, L208, L208D, L209D, L210, L210D	76 » 95		104789	SC		114780	SC
(Type 602) L307D, L308, L308D, L309D, L310, L310D	76 » 95		104789	SC		114780	SC
(Type 611) L407D, L408D, L409D, L410, L410D	76 » 95		204021	GC		714022	PLL
(Type 309, 310) L319B, L319D, L405, L405D, L406, L406D, L406DG, L406G, L407, L407D, L408, L409			201498	GC		211498	GC
(Type 309, 310) L408D, L408 DG, L408G, L409, L410 			201781	GC		211781	GC
(Type 309, 310) L408D, L408DG, L408G, L409, L410 			704672	PLL		714672	PLL
(Type 309, 310) L508D, L508DG, L608D, L613 			201781 704672	GC PLL		211781	GC
<b>"LF" SERIES</b>							
(Type 309) LF406D, LF408G, LF409, LF410 			201781 704672	GC PLL		714672	GC
<b>"LK" SERIES</b>							
(Type 309) LK408G, LK409, LK410, LK508DG, LK608 D 			201781	GC		211781	GC
(Type 309) LK408G, LK409, LK410, LK508DG, LK608D 			704672	PLL		714672	GC



MODELE MODEL	ANNEE / YEAR						
		AVANT / FRONT			ARRIÈRE / REAR		
		GAZ / GAS	HYD	TYPE	GAZ / GAS	HYD	TYPE
<b>"LKO" SERIES</b>							
(Type 309) LKO406DG, LKO407D, LKO408G, LKO409 			201781 704672	GC PLL		211781 714672	GC
<b>"LP" SERIES</b>							
(Type 314) 608 : LP 			241782 744673	GC PLL		211781 714672	GC PLL
(Type 314) 709 : LP 			241782 744673	GC PLL		211781 714672	GC PLL
<b>"MB" SERIES</b>							
(Type 631) 90, 100, 120 (SPRINTER inclus.)	05.84 »		205171	GC		215172	GC
<b>SPRINTER I</b>							
(Type 901, 902) Serie 200 : 208 → 216	95 » 04.06	545540G	545540	JF	215238G	215238	GC
(Type 903) Serie 300 : 308 → 316	95 » 04.06	545540G	545540	JF	215238G	215238	GC
(Type 904) Serie 400 : 408 → 416  Except PTC/TLW 4,5t	95 » 04.06	545540G	545540	JF	215639G	215639	GC
(Type 904) Serie 400 : 408 → 416 PTC/TLW 4,5t	95 » 04.06	545610G	545610	JF	215639G	215639	GC
<b>SPRINTER II</b>							
(906)  3T, 3,5T	05.06 »	545759G	545759	JF	215894G	215894	GC
(906)  5T	05.06 »	545764G	545764	JF	215895G	215895	GC
<b>VANEO</b>							
(414) 1.6 (82,102), 1.9 (125)	01 »				115778G	115778	SC
(414) 1.7 CDi (75, 91)	01 »				115778G	115778	SC















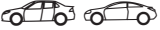

MODELE MODEL	ANNEE / YEAR						
		AVANT / FRONT			ARRIÈRE / REAR		
		GAZ / GAS	HYD	TYPE	GAZ / GAS	HYD	TYPE
<b>VIANO</b>							
(639) 2.0 CDi, 2.2 CDi	03 »				115718G	115718	SC
(639) 3.0V6 (CDi inclus), 3.2V6	03 »				115718G	115718	SC
<b>VITO</b>							
(Type 638) 108 → 114  Except 	96 » 06.03	<sup>(6)</sup> 545519G	<sup>(6)</sup> 545519	JF	115510G	115510	SC
(Type 639) 109 → 122	07.03 » 09.14				115718G	115718	SC



















## MITSUBISHI

<b>MITSUBISHI CELESTE</b>							
<b>1400 - 1600 - 2000</b>							
(A72, A73, A78)	75 » 81		444529	FU		114520	SC
<b>MITSUBISHI COLT &amp; MIRAGE</b>							
<b>Mirage 1200</b>							
(A151A, A155A)	77 » 83		444863	FU	114864G	114864	SC
<b>Mirage 1400</b>							
(A152A, A156A)	77 » 83		444863	FU	114864G	114864	SC
<b>Mirage 1600</b>							
(A153A - A157A)	77 » 83		444863	FU	114864G	114864	SC
<b>Mirage Turbo</b>							
(A152A)	82 » 83				114864G	114864	SC
<b>1200 --&gt; 1800</b>							
(C10)	84 » 88					115136	SC
<b>MITSUBISHI CORDIA &amp; TREDIA</b>							
<b>1400 --&gt; 2000</b>							
(A 210)	82 » 87				114864G	114864	SC
<b>MITSUBISHI DELICA</b>							
<b>DELICA</b>							
(T10, T12) 	68 » 05.79		244586	GC	114703G	114703	SC
(L03P/PV/PW) P, PV, PW	06.79 » 86		244586	GC	114703G	114703	SC



















MODELE MODEL	ANNEE / YEAR						
		AVANT / FRONT			ARRIÈRE / REAR		
		GAZ / GAS	HYD	TYPE	GAZ / GAS	HYD	TYPE
<b>MITSUBISHI FORTE</b>							
<b>LO21, LO22, LO25</b>							
L021P, L022P, L025P 	78 » 86		244586	GC		105128	SC
<b>LO22, LO26</b>							
L022G, L026G 	80 »		244586	GC		214082	GC
<b>MITSUBISHI GALANT COLT</b>							
<b>1300 - 2000</b>							
(A50, A 60, A110)  FTO, GTO inclus	69 » 77		444529	FU		114531	SC
<b>1300 - 1500</b>							
(A50V) 	69 » 73		444529	FU		114786	SC
<b>1600</b>							
(A110V) 	73 » 76		444529	FU		114535	SC
<b>MITSUBISHI GALANT - LAMBDA - SAPPORO - SIGMA</b>							
<b>1600</b>							
(A121A, A131) 	76 » 05.80		444529	FU		114532	SC
(A121A, A131A)  Sapporo	78 » 05.80		444529	FU		114532	SC
<b>1850</b>							
(A122A, A132) 	76 » 05.80		444529	FU		114532	SC
<b>2000</b>							
(A123A, A133) 	76 » 05.80		444529	FU		114532	SC
(A123A, A133A)  Sapporo	78 » 05.80		444878	FU		114532	SC
(A164A)  GLS, GSR Except Turbo	06.80 » 07.83		444878	FU			
(A163A)  GLX	06.80 » 07.83		444529	FU		114879	SC





















MODELE MODEL	ANNEE / YEAR						
		AVANT / FRONT			ARRIÈRE / REAR		
		GAZ / GAS	HYD	TYPE	GAZ / GAS	HYD	TYPE
<b>2000</b>							
(A163)  Sapporo	06.80 » 07.83		444529	FU		114879	SC
<b>2600</b>							
(A135) 	78 » 05.80		444878	FU			
(A 166) 	06.80 » 07.83		444878	FU			
<b>1600 - 1800</b>							
1600 (A161A), 1800 (A162A) 	06.80 » 07.83		444529	FU		114879	SC
<b>2300</b>							
(A167A)  GLXD, TD	06.80 » 07.83		444878	FU		114879	SC
(A167V)  , Turbo Diesel	83 » 84		444878	FU		114786	SC
<b>1600 ---&gt; 2000</b>							
(A112V, A121V, A123V, A161V, A163V, A168V) 	76 » 84		444529	FU		214921	GC
<b>MITSUBISHI L - SERIES</b>							
<b>L200 - 4x2</b>							
(K1)   1600 > 2500	86 » 95	244079G	244079	GC		214070	GC
(K6)   2000, 2500D	96 »	145023G	145023	SC		115024	GC
(K2, K3)   2000, 2600	86 » 95	744081G	744081	PLL	214082G	214082	GC
<b>L200 - 4x4</b>							
(K6)   2400, 2800D	96 »	145023G	145023	SC	115024G	115024	SC
(K7)   2400, 2500D	96 » 12.05	745488G	745488	PLL	715489G	715489	PLL















MODELE MODEL	ANNEE / YEAR						
		AVANT / FRONT			ARRIÈRE / REAR		
		GAZ / GAS	HYD	TYPE	GAZ / GAS	HYD	TYPE
<b>NEW L200</b>							
 KA5T, K9T, KN4T, KB9T (Made in Thailand)	01.06 »	348698G	348698	SR	218699G	218699	GC
 KB-T,KA-T 2,5 DI-D	11.05 »	349911G		SR	719942G		PLL
<b>L300 - 4x2</b>							
 1600 (LO32P, LO62P), 2300D (LO38P, LO68P)	79 » 05.86		144083	SC			
 1600 (LO32P)	06.86 » 05.94		144083	SC		214086	GC
 2500D (LO39P)	06.86 » 05.94				214086G	214086	GC
 1600 (P02V, P12V) 2000 (P03V, P13V) 2400 (P04V, P14V), 2500 D (P05V, P15V)	06.86 »	244088G	244088	GC	214086G	214086	GC
 1600 (LO32P), 2300D (LO38P)	79 » 05.86		144083	SC			
 1400 (P01W), 1600 (P02W, P12W)	06.86 »	244088G	244088	GC	214086G	214086	GC
 2000 (P03W), 2400 (P04W), 2500D (P05W, P15W)	06.86 »	244088G	244088	GC	214086G	214086	GC
<b>L300 - 4x4</b>							
 1800 (LO35G), 2000 (LO37G)	83 » 05.86		144083	SC			
<b>MITSUBISHI LANCER</b>							
<b>1200 - 1400</b>							
 1200 (A75) - 1400 (A72)	72 » 08.76		444529	FU		114520	SC
 1200 (A75, A141A) - 1400 (A72, A143A)	09.76 » 02.79		444533	FU		114520	SC
 1200 (A71V) - 1400 (A72 V)	72 » 08.76		444529	FU		114786	SC
 1200 (A75V) - 1400 (A72 V)	09.76 » 02.79		444533	FU		114786	SC







MODELE MODEL	ANNEE / YEAR						
		AVANT / FRONT			ARRIÈRE / REAR		
		GAZ / GAS	HYD	TYPE	GAZ / GAS	HYD	TYPE
<b>1600 - 2000</b>							
 1600 (A73) - 2000 (A70, A71)	72 » 08.76		444533	FU		114520	SC
 1600 (A73, A144A) - 2000 (A70, A71)	09.76 » 02.79		444529	FU		114520	SC
<b>1200</b>							
Berline/Saloon 1200 (A171)  → 6102532	03.79 » 12.79		444529	FU			
 1200 (A171)  6102533 →	01.80 » 83		444533	FU		114917	SC
<b>1400</b>							
 1400 (A172)  → 6503419	03.79 » 12.79		444529	FU			
 1400 (A172)  6503420 →	01.80 » 83		444533	FU		114917	SC
<b>1600</b>							
 1600 (A174)  → 6402713	03.79 » 12.79		444529	FU			
 1600 (A174)  6402714 →	01.80 » 83		444533	FU		114917	SC
<b>1800</b>							
 1800 (A175)	80 » 83		444529	FU		114917	SC
<b>2000 TURBO</b>							
 2000 Turbo (A176A)	80 » 83					114917	SC
<b>1201 --&gt; 1600</b>							
 (A141V - A142V - A148V - A149V)	03.79 » 83		444533	FU		114786	SC
<b>F - 1200 - 1400</b>							
F  1200 (A155A) - 1400 (A156A)	82 » 84	444863G	444863	FU	114864G	114864	SC



MODELE MODEL	ANNEE / YEAR						
		AVANT / FRONT			ARRIÈRE / REAR		
		GAZ / GAS	HYD	TYPE	GAZ / GAS	HYD	TYPE
<b>F - 1400 Turbo</b>							
 F 1400 Turbo (A152)	82 » 84	444863G	444863	FU			
<b>1200 --&gt; 1800</b>							
 1200 > 1800 (C10)	84 » 88					115136	SC
<b>1500 - 1800</b>							
 1500 (CV12) - 1800 (CV14)	84 » 05.92					105128	SC
<b>MITSUBISHI PAJERO - MONTERO - SHOGUN 4x4</b>							
<b>PAJERO</b>							
(L04, P25L)  Ressorts à lames AR/Rear	82 » 91	244991G	244991	GC	214880G	214880	GC
(L14)  AR/Rear	88 » 91	244991G	244991	GC	215204G	215204	GC
(V1, V3)  Ressorts à lames AR/Rear	91 » 97	745268G	745268	PLL	214880G	214880	GC
(V2, V4)  AR/Rear (Court/Short, Long)	<sup>(1)</sup> 91 »	745268G	745268	PLL	755269G	755269	PLL
(V6, V7) (Court/Short, Long)	99 » 01.07	345586G		SR	255587G	255587	GC
<b>PAJERO SPORT</b>							
(K9) 	98 » 09	745268G	745268	PLL	715666G	715666	PLL
<b>MITSUBISHI SPACE WAGON , SPACE VAN (CHARIOT) , EXPO</b>							
<b>1800 - 2000</b>							
 1800 (D05, D09) - 2000 (D04)	83 » 04.91				114864G	114864	SC
<b>2000</b>							
 2000 (D08)	85 » 04.91				114864G	114864	SC



MITSUBISHI

MODELE MODEL	ANNEE / YEAR						
		AVANT / FRONT			ARRIÈRE / REAR		
		GAZ / GAS	HYD	TYPE	GAZ / GAS	HYD	TYPE

**MITSUBISHI STARION**

**2000**

2000 (A182) 	82 » 86		444529	FU		114879	SC
--	---------	--	--------	----	--	--------	----

**2000 Turbo**

2000 Turbo (A183) 	82 » 86		444878	FU			
--	---------	--	--------	----	--	--	--

MORRIS

**MORRIS**

**MARINA**



MK I, MK II 	71 » 82					134182	SC
--	---------	--	--	--	--	--------	----

ITAL  → 701989	80 » 83					134182	SC
---	---------	--	--	--	--	--------	----

ITAL  701990 →	83 » 84		105147	SC		134182	SC
--	---------	--	--------	----	--	--------	----

**MINI**

  Except 	59 »		101495	SC		151495	SC
---	------	--	--------	----	--	--------	----

 	63 » 67		101495	SC		151696	SC
---	---------	--	--------	----	--	--------	----

MOSKVITCH

**MOSKVITCH**

**400 SERIES**

402, 403, 407, 408, 412, 423, 426, 427, 433, 434	56 »		141527	SC		111528	SC
---	------	--	--------	----	--	--------	----

**2100 SERIES**

2136, 2137, 2138, 2140	74 »					111528	SC
------------------------	------	--	--	--	--	--------	----

**SCALDIA**

SCALDIA	63 »					111528	SC
---------	------	--	--	--	--	--------	----

NISSAN

**NISSAN**









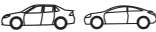
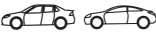

**NISSAN ALMERA, Except TINO**

**ALMERA I**

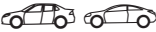

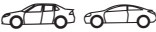
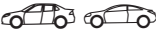

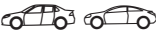







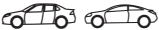









(Series N15) 1.4, 1.6, 2.0D Except Tino	95 » 12.97	<sup>(1)</sup> 545357G L 545358G R	<sup>(1)</sup> 545357 L 545358 R	JF	<sup>(1)</sup> 355381G	<sup>(1)</sup> 355381	SR
---	------------	--	--	----	---------------------------	--------------------------	----

(Series N15) 2.0 Gti Except Tino	95 » 07.97	<sup>(1)</sup> 545357G L 545358G R	<sup>(1)</sup> 545357 L 545358 R	JF	<sup>(1)</sup> 355381G	<sup>(1)</sup> 355381	SR
--	------------	--	--	----	---------------------------	--------------------------	----





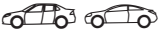
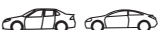





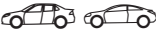

MODELE MODEL	ANNEE / YEAR						
		AVANT / FRONT			ARRIÈRE / REAR		
		GAZ / GAS	HYD	TYPE	GAZ / GAS	HYD	TYPE
<b>ALMERA I</b>							
(Series N15) 2.0 Gti Except Tino	08.97 » 12.97	(1) 545357G L 545358G R	(1) 545357 L 545358 R	JF			
<b>NISSAN BLUEBIRD</b>							
<b>BLUEBIRD</b>							
(Series 510) 	67 » 69		(2) 444638	FU		151055	SC
(Series 510) 	69 » 04.71		(2) 444179	FU		151055	SC
(Series 510)  Except Series JN510 , JP510 (Taxi inclus)	05.71 » 72		(2) 444291	FU		151055	SC
(Series 510)  Series JN510 , JP510 (Taxi inclus)	05.71 » 72		(2) 444291	FU		151762	SC
(Series 510) 	67 » 04.71		(2) 444179	FU			
(Series 510) 	05.71 » 72		(2) 444291	FU			
<b>NISSAN BLUEBIRD U</b>							
<b>160 B - 180 B - 200 B</b>							
(Series 610) 	71 » 06.76		444291	FU		151055	SC
<b>180 B SSS - 200GTX , GTXE</b>							
(Series 610) 	73 » 06.76		444291	FU		151055	SC
<b>160 B - 180 B</b>							
(Series 610) 	71 » 06.76		444291	FU		111955	SC
(Series 810)  Ressorts à lames AR/Rear	07.76 » 10.79		444638	FU			
(Series 810) 	07.76 » 10.79		444638	FU		111955	SC

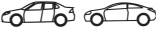















MODELE MODEL	ANNEE / YEAR						
		AVANT / FRONT			ARRIÈRE / REAR		
		GAZ / GAS	HYD	TYPE	GAZ / GAS	HYD	TYPE
<b>160 B - 180 B - 180 B SSS - 200 B</b>							
(Series 810)  AR/Rear	07.76 » 10.79		444638	FU			
<b>1600 - 1800 - 2000 - 2.0D</b>							
(Series 910) 	11.79 » 09.83	444630G	444630	FU			
<b>1800 - 2000 - 2.0D</b>							
(Series 910)  Ressorts à lames AR/Rear	11.79 » 09.83	444630G	444630	FU			
(Series 910)  Ressorts Hélicoïdaux AR/Rear	11.79 » 09.83	444630G	444630	FU	204587G	204587	GC
<b>NISSAN CAB , KING CAB (Pick up)</b>							
<b>Pick up</b>							
(Series 520 , 620)	65 » 79	144850G	144850	SC	234600G	234600	GC
(Series 720)  	79 » 08.85	144850G	144850	SC	234600G	234600	GC
(Series 720)  	79 » 12.81	144850G	144850	SC	234600G	234600	GC
(Series 720)  	01.82 » 08.85	144850G	144850	SC	211765G	211765	GC
(Series D21)  	09.85 » 01.98	144850G	144850	SC	115463G	115463	SC
(Series D21)  	09.85 » 01.98	145462G	145462	SC	115463G	115463	SC
(Series D22)  	02.98 »	144850G	144850	SC	115463G	115463	SC
(Series D22)  	02.98 »	245640G	245640	GC	215651G	215651	GC
<b>NISSAN CEDRIC - GLORIA</b>							
<b>CEDRIC</b>							
(Series 230, 330) 	71 » 02.79		141761	SC		211765	GC
(Series 430) 	03.79 » 09.83		144727	SC		154876	SC
(Series 230, 330) 	71 » 02.79		141761	SC		211765	GC

























MODELE MODEL	ANNEE / YEAR						
		AVANT / FRONT			ARRIÈRE / REAR		
		GAZ / GAS	HYD	TYPE	GAZ / GAS	HYD	TYPE
<b>CEDRIC</b>							
(Series 430) 	03.79 » 09.83		144727	SC		211765	GC
<b>CHERRY</b>							
(Series E10)  100 A, 120 A	70 » 08.74					154286	SC
(Series E10)  100 A	70 » 08.74					174320	SC
(Series F10, F11)  100 A FII, 120 A FII, 140 A FII	09.74 » 03.78		444641 <sup>(4)</sup>	FU		154286	SC
(Series F10) Beak/Estate 100 A FII, 120 A FII	09.74 » 03.78		444641 <sup>(4)</sup>	FU		174320	SC
(Series N10)  120 A, 140 A	04.78 » 04.82		444641 <sup>(4)</sup>	FU		154286	SC
(Series N10)  120 A, 140 A	04.78 » 04.82		444641 <sup>(4)</sup>	FU		115126	SC
(Series N12) 	05.82 » 04.86				155129G	155129	SC
<b>NISSAN CHERRY Made in Europe</b>							
<b>CHERRY</b>							
Suspension = Alfa 33 - 1.2, 1.5	83 » 85				155129G	155129	SC
<b>NISSAN CIVILAN</b>							
<b>CIVILAN W41</b>							
(TD42/TD 42T/TB 45E) [Bus 30 places]	10.02 »		749216	PLL		839217	PLL
<b>NISSAN FAIRLADY</b>							
<b>FAIRLADY</b>							
(Series S30) 240 Z, 260 Z	69 » 06.74		444141	FU		454142	FU
(Series S130) 280 ZX, 280 ZX (2+2), 280Turbo	07.78 » 09.83		444630	FU			
<b>NISSAN INTERSTAR</b>							
<b>INTERSTAR</b>							
(X70)   Except 	02 »		205461	GC		215465	GC



















MODELE MODEL	ANNEE / YEAR						
		AVANT / FRONT			ARRIÈRE / REAR		
		GAZ / GAS	HYD	TYPE	GAZ / GAS	HYD	TYPE
<b>NISSAN JUKE</b>							
<b>JUKE</b>							
(F15) 	06.10 »	545972G L 545973G R	545972 L 545973 R	JF	255974G	255974	GC
<b>NISSAN KUBISTAR</b>							
<b>KUBISTAR</b>							
(X76)  Except  Pampa	<sup>(5)</sup> 04 »	545438G	545438	JF	115439G	115439	SC
(X76)   Except Pampa	<sup>(5)</sup> 04 »	545438G	545438	JF	215430G	215430	GC
(X76)  Pampa	04 »	545588G	545588	JF	215589G	215589	GC
<b>NISSAN LAUREL</b>							
<b>LAUREL</b>							
(Series C30)  1800	67 » 04.72		444179	FU		151055	SC
(Series C130) 	05.72 » 01.77	444638G	444638	FU			
(Series C230) 	02.77 » 10.80	444638G	444638	FU	354639G	354639	SR
(Series C31) 	11.80 » 09.84	444638G	444638	FU	354639G	354639	SR
(Series C31) 	11.80 » 09.84	444638G	444638	FU			
(Series C32)  	10.84 »					<sup>(6)</sup> 354639	SR
<b>NISSAN LEOPARD</b>							
<b>LEOPARD</b>							
(JF30) 1800	80 » 83	444630G	444630	FU			
(HF30, PF30) 2000 → 3000	80 » 85	444630G	444630	FU			











MODELE MODEL	ANNEE / YEAR						
		AVANT / FRONT			ARRIÈRE / REAR		
		GAZ / GAS	HYD	TYPE	GAZ / GAS	HYD	TYPE
<b>NISSAN MICRA - MARCH</b>							
<b>MICRA 1</b>							
(K10) 	83 » 09.92	545183G	545183	JF	355184G	355184	SR
<b>MICRA II</b>							
(K11)  Except ABS	10.92 » 12.02	545359G L 545350G R	545359 L 545350 R	JF	155192G	155192	SC
<b>MICRA III</b>							
(K12)  Except 160 SR	01.03 » 10.10	545634G L 545635G R	545634 L 545635 R	JF	155636G	155636	SC
<b>MICRA IV</b>							
(K13) 	11.10 »	545978G L 545979G R	545978 L 545979 R	JF	155636G	155636	SC
<b>NISSAN NAVARA</b>							
<b>NAVARA</b>							
(D40)   	04 »				115606G	115606	SC
(D40)   2.5 Dci (-) H/D	07.05 »	349753G		SR	719756G		PLL
(D40)      (+) H/D	09.09 » 01.10	349753G		SR	719756G		PLL
(D40)  3.0D V6 (+) H/D	05.10 »				719756G		PLL
<b>NISSAN NOTE</b>							
<b>NOTE</b>							
	06 » 06.13	545726G L 545727G R	545726 L 545727 R	JF	155728G	155728	SC
<b>NISSAN NP</b>							
<b>NP 300</b>							
 	08 »	245640G	245640	GC	215651G	215651	GC
<b>NISSAN NV 200</b>							
<b>NV 200</b>							
  Evalia	10 »				215909G	215909	GC





MODELE MODEL	ANNEE / YEAR						
		AVANT / FRONT			ARRIÈRE / REAR		
		GAZ / GAS	HYD	TYPE	GAZ / GAS	HYD	TYPE
<b>NISSAN NV 400</b>							
<b>NV 400</b>							
   PROPULSION/RWD (!) (+)  AR/Rear Except Pneumatic Suspension	11 »		545943	JF		215045	GC
   PROPULSION/RWD (!) (+)  AR/Rear Except Pneumatic Suspension	11 »		545943	JF		215046	GC
   TRACTION/FWD  Except Pneumatic Suspension	11 »		545943	JF		215044	GC
<b>NISSAN PATHFINDER 4x4</b>							
<b>PATHFINDER</b>							
(Series D21) <sup>(3)</sup> 	87 » 93	245112G	245112	GC	214006G	214006	GC
(Series R20) 	93 » 96	245112G	245112	GC	215113G	215113	GC
(Series R51) 	03.05 »					715794	PLL
<b>NISSAN PATROL - SAFARI 4x4</b>							
<b>PATROL</b>							
(60, 61)	61 » 05.80		764836	PLL		245112	GC
(Type Y60) GR 1	87 » 09.97	764062G	764062	PLL	714063G	714063	PLL
(Type Y61) GR 2	10.97 » 09.04		765572	PLL		715573	PLL
<b>PATROL &amp; SAFARI</b>							
(Series 160) Except GR	06.80 » 03.89		764836	PLL		245112	GC
Type (NM/SA) 160/743, 260/743 Except GR	04.89 »	764062G	764062	PLL	214064G	214064	GC
<b>PATROL EBRO</b>							
(Series 260) Except GR (Made in ESP)	82 » 03.89		764836	PLL		245112	GC

























MODELE MODEL	ANNEE / YEAR						
		AVANT / FRONT			ARRIÈRE / REAR		
		GAZ / GAS	HYD	TYPE	GAZ / GAS	HYD	TYPE
<b>NISSAN Pick up</b>							
<b>Pick up JUNIOR</b>							
(NG21) 140, N140	70 »		245250	GC		215261	GC
<b>NISSAN PRESIDENT</b>							
<b>PRESIDENT</b>							
(Series H150) 3000, 4000	65 » 72		141761	SC		151055	SC
(Series H250) 4400	73 » 83		141761	SC		151055	SC
<b>NISSAN PRIMASTAR</b>							
<b>PRIMASTAR</b>							
	01 »		545593	JF		215597	GC
<b>NISSAN QASHQAI</b>							
<b>QASHQAI</b>							
	07 » 01.14	545822G L 545823G R	545822 L 545823 R	JF	215824G	215824	SC
<b>QASHQAI + 2</b>							
 Except Russia, Ukraine	08 » 06.14	545822G L 545823G R	545822 L 545823 R	JF	215824G	215824	SC
<b>NISSAN SILVIA - GAZELLE</b>							
<b>SILVIA</b>							
200 SX	75 » 07.79					154334	SC
S 11	08.79 » 07.83		444754	FU		154755	SC
S 12	08.83 » 04.88		444630	FU			
<b>NISSAN SKYLINE</b>							
<b>1600 - 1800 - 2000 GT</b>							
(Series C10) 	68 » 08.72		444638	FU			
<b>160 --&gt; 240</b>							
(Series C110) 	09.72 » 08.77		444638	FU			
<b>160 K - 180 K - 200 K - 240 K - 280 D</b>							
(Series C210) 	09.77 » 07.81		444638	FU			
<b>1800 - 2000 - 2800</b>							
(Series R30) 	08.81 »		444638	FU			



MODELE MODEL	ANNEE / YEAR						
		AVANT / FRONT			ARRIÈRE / REAR		
		GAZ / GAS	HYD	TYPE	GAZ / GAS	HYD	TYPE
<b>1600 - 1800</b>							
(Series C10) 	68 » 08.72		444638	FU			
<b>160 K - 180 K</b>							
(Series C110) 	09.72 » 08.77		444638	FU			
(Series C210) 	09.77 » 07.81		444638	FU			
<b>1800 - 2000</b>							
(Series R30) 	08.81 »		444638	FU			
<b>NISSAN STANZA</b>							
<b>STANZA</b>							
(Series T11) 1600 - 1700 D - 1800	81 » 85		444817	FU		454818	FU
<b>NISSAN SUNNY - SENTRA</b>							
<b>1200</b>							
(Series B110) 	70 » 73		444296	FU		154297	SC
(Series B110) 	70 » 73		444296	FU		154611	SC
(Series B110) 	70 » 73		444296	FU	114786G	114786	SC
(Series B120) 	70 » 73		444296	FU	114786G	114786	SC
<b>120 Y</b>							
(Series B210)  Except ⑬	73 » 78		444296	FU		154297	SC
(Series B210)  (+) ⑬	76 » 78		444712	FU		154297	SC
(Series B210)  Except ⑬	73 » 78		444296	FU		154612	SC
(Series B210)  (+) ⑬	76 » 78		444712	FU		154612	SC

















MODELE MODEL	ANNEE / YEAR						
		AVANT / FRONT			ARRIÈRE / REAR		
		GAZ / GAS	HYD	TYPE	GAZ / GAS	HYD	TYPE
<b>120 Y</b>							
(Series B210)  Except ⑬	73 » 78		444296	FU	114786G	114786	SC
(Series B210)  ⑬	76 » 78		444712	FU	114786G	114786	SC
<b>120 Y &amp; 140 Y</b>							
(Series B310)  	78 » 81		444712	FU		154713	SC
(Series B310) 	78 » 81		444296	FU		105128	SC
<b>140 Y</b>							
(Series B310)  ≡ AR/Rear	78 » 81		444296	FU		154713	SC
(Series B310)  Except ⑬ Ressorts à lames AR/Rear	78 » 81		444296	FU	114786G	114786	SC
(Series B310)  ⑬ Ressorts à lames AR/Rear	78 » 81		444712	FU	114786G	114786	SC
<b>150 Y</b>							
(Series B310)    	80 » 81		444712	FU		154713	SC
<b>SUNNY</b>							
(Series B11)     (+) ≡ AR/Rear	82 » 86				155129G	155129	SC
<b>NISSAN SUNNY EXCELLENT</b>							
<b>1400</b>							
(Series B110)  	71 » 04.73		444638	FU		154297	SC
(Series B110) 	71 » 04.73		444638	FU		151477	SC
(Series B210)  	05.73 » 78		444754	FU		154297	SC



















MODELE MODEL	ANNEE / YEAR						
		AVANT / FRONT			ARRIÈRE / REAR		
		GAZ / GAS	HYD	TYPE	GAZ / GAS	HYD	TYPE
<b>1400</b>							
(Series B210) 	05.73 » 78		444754	FU		154612	SC
<b>NISSAN TERRANO</b>							
<b>TERRANO</b>							
(Series D21) 	87 » 93	245112G	245112	GC	214006G	214006	GC
<b>TERRANO II</b>							
(Series R20) 	93 »	245112G	245112	GC	215113G	215113	GC
<b>NISSAN TRADE</b>							
<b>TRADE</b>							
 2.8 Made in ESP	» 03.93		245536	GC			
 3.0	06.94 » 03.97		245742	GC			
 2.8 Made in ESP	» 03.93		245536	GC		215537	GC
 3.0	04.93 »		245742	GC		115743	SC
 100	06.94 » 03.97		245742	GC			
 100	04.93 »		245742	GC		115743	SC
<b>NISSAN URVAN</b>							
<b>URVAN</b>							
E20, E22, E23	04.78 » 10.86		244088	GC			
<b>NISSAN VANETTE</b>							
<b>VANETTE</b>							
C 120, C 121, C122	78 » 87	104992G	104992	SC	114786G	114786	SC
C 220 Made in ESP	87 »	104992G	104992	SC	114786G	114786	SC
C 22 Ressorts à lames AR/Rear	86 »	105139G	105139	SC			
C 22  AR/Rear	86 »	105139G	105139	SC	155130G	155130	SC

















MODELE MODEL	ANNEE / YEAR						
		AVANT / FRONT			ARRIÈRE / REAR		
		GAZ / GAS	HYD	TYPE	GAZ / GAS	HYD	TYPE
<b>NISSAN VIOLET - AUSTER</b>							
<b>VIOLET</b>							
(Series J710, L710)  Ressorts à lames AR/Rear	73 » 07.77		444291	FU		151762	SC
(Series L710, P710)  (+) SSS AR/Rear	73 » 07.77		444291	FU		151055	SC
(Series L710, V710) 	73 » 07.77		444291	FU		111955	SC
(Series A10)  (+) SSS	08.77 » 81		444754	FU		154755	SC
(Series A10) 	08.77 » 81		444754	FU		214921	GC
<b>NISSAN X-TRAIL</b>							
<b>X-TRAIL</b>							
(T31)   	06.07 » 06.14	545825G L 545826G R	545825 L 545826 R	JF	215827G	215827	GC
<b>NSU</b>							
<b>NSU</b>							
Prinz III, IV  47137548 →	64 » 65		141586	SC			
Prinz IV Sportprinz  4114645 →	64 » 65		141586	SC			
1000  6761481 →	64 »		141586	SC		171632	SC
Wankel Spider	65 »		141586	SC		171632	SC
1000 Standard (Type L, S)	65 »					171632	SC
110 - 1000 - 1200 (C, CS, TT, TTS inclus.)	66 »					171632	SC
<b>OPEL</b>							
<b>OPEL ADAM</b>							
<b>ADAM</b>							
 Except Adam Rocks	12 »	545961G L 545962G R	545961 L 545962 R	JF	155963G	155963	SC

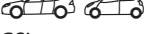

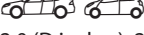

















MODELE MODEL	ANNEE / YEAR						
		AVANT / FRONT			ARRIÈRE / REAR		
		GAZ / GAS	HYD	TYPE	GAZ / GAS	HYD	TYPE
<b>OPEL ADMIRAL</b>							
<b>ADMIRAL</b>							
	64 » 03.69		141664	SC		254328	SC
	04.69 » 78		141664	SC		151014	SC
<b>OPEL AGILA</b>							
<b>AGILA I</b>							
(H00) 	99 » 02.08	545896G L 545897G R	545896 L 545897 R	JF	115665G	115665	SC
<b>AGILA II</b>							
(H08) 	03.08 »	545729G L 545720G R	545729 L 545720 R	JF	155715G	155715	SC
<b>OPEL ASCONA</b>							
<b>ASCONA</b>							
A  (Voyage inclus.)	70 » 07.75		141961	SC	151040G	151040	SC
B 	08.75 » 07.81	144385G	144385	SC	154489G	154489	SC
C 1.3:  → 1.003.026	08.81 » 08.84	444803G	444803	FU	154651G	154651	SC
C 1.6:  → 5.000.000	08.81 » 08.84	444803G	444803	FU	154651G	154651	SC
C 1.8:  → 6.000.000	08.81 » 08.84	444803G	444803	FU	154651G	154651	SC
C 1.3:  1.003.027 →	09.84 » 88	444950G	444950	FU	154651G	154651	SC
C 1.6:  5.000.001 →	09.84 » 88	444950G	444950	FU	154651G	154651	SC
C 1.8:  6.000.001 →	09.84 » 88	444950G	444950	FU	154651G	154651	SC
C 2.0	86 »	444950G	444950	FU	154651G	154651	SC
<b>OPEL ASTRA</b>							
<b>ASTRA F</b>							
(Series 50)   Except GSi	91 » 02.98	445156G	445156	FU	155149G	155149	SC



















MODELE MODEL	ANNEE / YEAR						
		AVANT / FRONT			ARRIÈRE / REAR		
		GAZ / GAS	HYD	TYPE	GAZ / GAS	HYD	TYPE
<b>ASTRA F</b>							
(Series 50)  GSi	91 » 02.98	445157G	445157	FU	155158G	155158	SC
(Series 50)  Except GSi	91 » 99	445156G	445156	FU	155149G	155149	SC
(Series 50)  GSi	91 » 99	445157G	445157	FU	155158G	155158	SC
(Series 50)  Except Hydropneumatic Suspension	91 » 02.98	445156G	445156	FU	(2) 134652G	(2) 134652	SC
(Series 50)  GSi	91 » 02.98	445156G	445156	FU	134652G	134652	SC
<b>ASTRA F CLASSIC</b>							
 Except GSi	03.98 » 02	445156G	445156	FU	155149G	155149	SC
 GSi	03.98 » 02	445157G	445157	FU	155158G	155158	SC
 Except Hydropneumatic Suspension	03.98 » 05	445156G	445156	FU	(2) 134652G	(2) 134652	SC
<b>ASTRA G</b>							
(F08, F48, F69, T98)  Except 2.0, 2.2, (S)	(3) 03.98 » 02.04	545520G L 545531G R	545520 L 545531 R	JF	115534G	115534	SC
(F08, F48, F69, T98)  2.0 (D inclus.), 2.2 (D inclus.) (+) (S)	(3) 03.98 » 02.04	545532G L 545533G R	545532 L 545533 R	JF	115534G	115534	SC
(F07, T98)  Except 2.0 T, GTC	(3) 99 » 12.05	545532G L 545533G R	545532 L 545533 R	JF	115534G	115534	SC
(F07, T98)  Except 2.0, 2.2 Sport	03.98 » 10.04	545520G L 545531G R	545520 L 545531 R	JF	(2) 115535G	(2) 115535	SC
(F35, T98)  2.0 (D inclus.), 2.2 (D inclus.) (+) Sport	03.98 » 10.04	545532G L 545533G R	545532 L 545533 R	JF	115535G	115535	SC



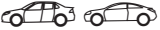

MODELE MODEL	ANNEE / YEAR						
		AVANT / FRONT			ARRIÈRE / REAR		
		GAZ / GAS	HYD	TYPE	GAZ / GAS	HYD	TYPE
<b>ASTRA G</b>							
(F70) 	03.98 » 10.04	545520G L 545531G R	545520 L 545531 R	JF	115535G	115535	SC
(T98)  Except 2.2	<sup>(3)</sup> 01 » 12.05	545520G L 545531G R	545520 L 545531 R	JF	115534G	115534	SC
(T98)  2.2 (D inclus.)	<sup>(3)</sup> 01 » 12.05	545532G L 545533G R	545532 L 545533 R	JF	115534G	115534	SC
<b>ASTRA H</b>							
 (+)  Inclus	<sup>(1)</sup> 03.04 » 11.09	545716G L 545717G R	545716 L 545717 R	JF	115535G	115535	SC
 GTC, Except 2.0T OPC 240	<sup>(1)</sup> 02.05 » 06.11	545716G L 545717G R	545716 L 545717 R	JF	115535G	115535	SC
 TwinTop (TT)	<sup>(1)</sup> 01.06 »	545716G L 545717G R	545716 L 545717 R	JF			
	<sup>(1)</sup> 11.04 » 11.10	545716G L 545717G R	545716 L 545717 R	JF	215653G	215653	GC
	11.04 »	545716G L 545717G R	545716 L 545717 R	JF	215653G	215653	GC
<b>ASTRA J</b>							
 Except 	<sup>(1)</sup> 12.09 »	545864G L 545865G R	545864 L 545865 R	JF	155866G	155866	SC
 Except 	<sup>(1)</sup> 12.10 »	545864G L 545865G R	545864 L 545865 R	JF	155866G	155866	SC
<b>ASTRA K</b>							
 Except 	<sup>(1)</sup> 06.15 »				255053G	255053	CG
<b>OPEL BLITZ</b>							
<b>BLITZ</b>							
BLITZ	» 09.65		161330	SC		211012	GC
1750, 1900 Kg	10.65 »		241011	GC		211012	GC
46 (F 303 Z - F333 Z)	73 »		161330	SC		211012	GC
CF Bedford	74 »	264243G	264243	GC	214244G	214244	GC
<b>OPEL CALIBRA</b>							
<b>CALIBRA</b>							
(85)  2.0i Except 16V	<sup>(1)</sup> 90 »	444056G	444056	FU	<sup>(2)</sup> 155181G	<sup>(2)</sup> 155181	SC





















MODELE MODEL	ANNEE / YEAR						
		AVANT / FRONT			ARRIÈRE / REAR		
		GAZ / GAS	HYD	TYPE	GAZ / GAS	HYD	TYPE
<b>CALIBRA</b>							
(85) 2.0i 16 V, 2.5 V6 Except Turbo	(1) 90 »	445272G	445272	FU	(2) 255273G	(2) 255273	GC
<b>OPEL COMBO</b>							
<b>COMBO</b>							
 Base/Basis = Kadett E	85 » 93	444640G	444640	FU	114050G	114050	SC
 Base/Basis = Corsa B	94 » 09.01	545179G	545179	JF	114050G	114050	SC
<b>COMBO TOUR</b>							
Base/Basis = Corsa C Except 	10.01 » 01.12	545568G	545568	JF	115627G	115627	SC
 Except 	02.12 »	545801G L 545802G R	545801 L 545802 R	JF	215803G	215803	GC
<b>COMBO CARGO</b>							
 Base/Basis = Corsa C Except 	10.01 » 12.11	545569G	545569	JF	115627G	115627	SC
 Except 	01.12 »	545801G L 545802G R	545801 L 545802 R	JF	215803G	215803	GC
<b>OPEL COMMODORE</b>							
<b>COMMODORE A</b>							
	67 » 01.72		141676	SC		141706	SC
<b>COMMODORE B</b>							
	02.72 » 07.77		141004	SC	154327G	154327	SC
	02.72 » 07.77		141004	SC	254328G	254328	GC
<b>COMMODORE C</b>							
	08.77 » 82	444666G	444666	FU	154327G	154327	SC
<b>OPEL CORSA</b>							
<b>CORSA A</b>							
(Séries 90)  1000 - 1200	83 » 93	545179G	545179	JF	154935G	154935	SC
(Séries 90)  1300 - 1400 - 1500 (D, TD) - 1600 (GSi)	83 » 93	545179G	545179	JF	254995G	254995	GC

























MODELE MODEL	ANNEE / YEAR						
		AVANT / FRONT			ARRIÈRE / REAR		
		GAZ / GAS	HYD	TYPE	GAZ / GAS	HYD	TYPE
<b>CORSA B</b>							
(Séries 70, F35)  1.0 - 1.2	93 » 09.00	545179G	545179	JF	154935G	154935	SC
(Séries 70, F35)  1.4 - 1.5 (D, TD) - 1.6 (GSi) - 1.7 (D, TD)	93 » 09.00	545179G	545179	JF	254995G	254995	GC
 Combo	94 » 09.01	545179G	545179	JF	114050G	114050	SC
<b>CORSA A &amp; B</b>							
 Corsavan	83 » 00	545179G	545179	JF	254995G	254995	GC
<b>CORSA C</b>							
(F08, F68)  1.0, 1.2, 1.3 CDTi, 1.7 Di Except (SS) Except 	10.00 » 08.06	545568G	545568	JF	155560G	155560	SC
(F08, F68)  Sport 1.4, 1.7 Dti, 1.7CDTi, 1.8 (GSi) Except (SS) Except 	10.00 » 08.06	545568G	545568	JF	155571G	155571	SC
(F08, F68)   (+) (SS) Except 1.6 OPC, 	10.00 » 08.06	545569G	545569	JF	155571G	155571	SC
(F08, W5L)  Except 	10.01 » 08.06	545569G	545569	JF	115627G	115627	SC
<b>CORSA D</b>							
  Except 1.6 Turbo 192cv, 1.6 Turbo 210cv Except GSi, OPC, (SS)	09.06 »	545735G L 545736G R	545735 L 545736 R	JF	155605G	155605	SC
 AFFAIRES	06 »	545735G L 545736G R	545735 L 545736 R	JF	155605G	155605	SC
<b>OPEL DIPLOMAT</b>							
<b>DIPLOMAT</b>							
	64 » 03.69		141664	SC		254328	SC
	04.69 » 7		141664	SC		151014	SC

























MODELE MODEL	ANNEE / YEAR						
		AVANT / FRONT			ARRIÈRE / REAR		
		GAZ / GAS	HYD	TYPE	GAZ / GAS	HYD	TYPE
<b>OPEL FRONTERA 4x4</b>							
<b>FRONTERA A</b>							
 (52 - 53 - 5J)	91 » 03.95	745319G	745319	PLL	215321G	215321	GC
 (54 - 55 - 5B - 5K - 5U)	04.95 » 09.98	745310G	745310	PLL	715496G	715496	PLL
<b>FRONTERA B</b>							
	10.98 » 12.05	245513G	245513	GC	255514G	255514	GC
<b>OPEL GT</b>							
<b>GT</b>							
1100, 1900	69 »		141530	SC		141706	SC
<b>OPEL INSIGNIA</b>							
<b>INSIGNIA</b>							
 Except OPC, 2.8 V6 Turbo	08 »	545867G L 545868G R	545867 L 545868 R	JF	255869G	255869	GC
 Except OPC, 2.8 V6 Turbo	08 »	545867G L 545868G R	545867 L 545868 R	JF			
 Except OPC	08 »	545867G L 545868G R	545867 L 545868 R	JF			
<b>OPEL KADETT</b>							
<b>KADETT A</b>							
	63 » 66		141530	SC		151541	SC
	67 » 70		141530	SC		141706	SC
<b>KADETT B</b>							
	65 » 67		141530	SC		151541	SC
	68 » 08.73		141530	SC		141706	SC
<b>KADETT C</b>							
 Except City, GT/E, Rallye	09.73 » 07.79	144385G <sup>(4)</sup>	144385 <sup>(4)</sup>	SC	154327G	154327	SC
 City	09.73 » 07.79	144385G <sup>(4)</sup>	144385 <sup>(4)</sup>	SC	141706G	141706	SC
 GT/E - Rallye	09.73 » 07.79	144413G	144413	SC		254414	GC
	09.73 » 07.79	144385G <sup>(4)</sup>	144385 <sup>(4)</sup>	SC	141706G	141706	SC
<b>KADETT D</b>							
	08.79 » 84	444640G	444640	FU	154651G	154651	SC
	08.79 » 84	444640G	444640	FU	134652G	134652	SC



































MODELE MODEL	ANNEE / YEAR						
		AVANT / FRONT			ARRIÈRE / REAR		
		GAZ / GAS	HYD	TYPE	GAZ / GAS	HYD	TYPE
<b>KADETT E</b>							
 (  ) → J2791967 ou/or (  ) → J5273427	84 » 07.88	444640G	444640	FU	154651G	154651	SC
 (  ) J2791968 → ou/or (  ) J5273428 →	08.88 » 93	444640G	444640	FU	155149G	155149	SC
	90 » 93	444640G	444640	FU	155149G	155149	SC
	84 » 93	444640G	444640	FU	134652G	134652	SC
 COMBO	85 » 93	444640G	444640	FU	114050G	114050	SC
<b>OPEL KAPITAN</b>							
<b>KAPITAN</b>							
	64 » 03.69		141664	SC		254328	SC
	04.69 » 78		141664	SC		151014	SC
<b>OPEL MANTA</b>							
<b>MANTA A</b>							
	70 » 07.75		141961	SC	151040G	151040	SC
<b>MANTA B</b>							
	08.75 » 88	144385G	144385	SC	154489G	154489	SC
<b>OPEL MERIVA</b>							
<b>MERIVA A</b>							
 Except OPC	02 » 03.10	545568G	545568	JF	115627G	115627	SC
<b>MERIVA A CLASSIC</b>							
 	04.10 »	545568G	545568	JF	115627G	115627	SC
<b>MERIVA B</b>							
 	04.10 »	545842G L 545843G R	545842 L 545843 R	JF	215844G	215844	GC
<b>OPEL MIDI</b>							
<b>MIDI</b>							
	85 »	144083G	144083	SC	214070G	214070	GC
	85 »					214070	GC
<b>OPEL MOKKA</b>							
<b>MOKKA</b>							
	12 »	545956G L 545957G R	545956 L 545957 R	JF	255958G	255958	GC



































MODELE MODEL	ANNEE / YEAR						
		AVANT / FRONT			ARRIÈRE / REAR		
		GAZ / GAS	HYD	TYPE	GAZ / GAS	HYD	TYPE
<b>OPEL MONTEREY 4x4</b>							
<b>MONTEREY</b>							
 (UBS)	92 » 03.95	745319G	745319	PLL	215322G	215322	GC
 (UBS)	04.95 »	745310G	745310	PLL	215322G	215322	GC
<b>OPEL MONZA</b>							
<b>MONZA</b>							
	78 » 87	444666G	444666	FU	151014G	151014	SC
<b>OPEL MOVANO</b>							
<b>MOVANO</b>							
(E9, F9, J9) Except 	98 » 12.09		205461	GC		215465	GC
(E9, F9, J9) (+) 	98 » 12.09		205461	GC			
(H9, U9) Except 	98 » 12.09		205461	GC		215466	GC
(H9, U9) (+) 	98 » 12.09		205461	GC			
N9 Except 	98 » 12.09		205585	GC		215465	GC
N9 (+) 	98 » 12.09		205585	GC			
<b>MOVANO B</b>							
   PROPULSION/RWD (!) (+) Roues AR Simples/With Rear Single Wheels Except Pneumatic Suspension	01.10 »		545943	JF		215045	GC
   PROPULSION/RWD (!) (+)  AR/Rear Except Pneumatic Suspension	01.10 »		545943	JF		215046	GC
   TRACTION/FWD  Except Pneumatic Suspension	01.10 »		545943	JF		215044	GC
<b>OPEL OLYMPIA</b>							
<b>OLYMPIA A</b>							
	53 » 06.57		161349	SC		161330	SC







































MODELE MODEL	ANNEE / YEAR						
		AVANT / FRONT			ARRIÈRE / REAR		
		GAZ / GAS	HYD	TYPE	GAZ / GAS	HYD	TYPE
<b>OLYMPIA A</b>							
	07.57 » 12.63		141376	SC		151377	SC
	67 » 70		141530	SC		141706	SC
<b>OPEL OMEGA</b>							
<b>OMEGA A</b>							
  Except Lotus	<sup>(1)</sup> 86 » 04.94					155131G	155131 SC
	<sup>(1)</sup> 86 » 04.94					155120G <sup>(2)</sup>	155120 <sup>(2)</sup> SC
<b>OMEGA B</b>							
	<sup>(1)</sup> 05.94 » 07.03					155131G	155131 SC
<b>OPEL REKORD</b>							
<b>REKORD A - B - C</b>							
	63 » 01.72		141676	SC		151706	SC
<b>REKORD D</b>							
    Except 2100 D	02.72 » 07.77		141004	SC		154327	SC
   2100 D	02.72 » 07.77		141004	SC		151040	SC
	02.72 » 07.77		141004	SC		254328	GC
<b>REKORD E</b>							
  Except Diesel	08.77 » 86	444666G	444666	FU		154327	SC
  Diesel	08.77 » 12.82	444666G	444666	FU		151040	SC
  Diesel	01.83 » 86	444666G	444666	FU		154327	SC
 	08.77 » 86	444666G	444666	FU		254328	GC
<b>REKORD P1</b>							
 	53 » 06.57		161349	SC		161330	SC
	53 » 06.57		161349	SC		171340	SC
<b>REKORD P1 - P2</b>							
 	07.57 » 12.63		141376	SC		151377	SC
	07.57 » 12.63		141376	SC		151340	SC
<b>OPEL SENATOR</b>							
<b>SENATOR</b>							
	78 » 08.87	444666G	444666	FU		151014G	151014 SC
	<sup>(1)</sup> 09.87 » 95					155131G	155131 SC





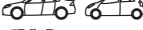









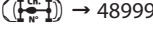

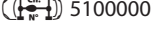



MODELE MODEL	ANNEE / YEAR						
		AVANT / FRONT			ARRIÈRE / REAR		
		GAZ / GAS	HYD	TYPE	GAZ / GAS	HYD	TYPE
<b>OPEL SIGNUM</b>							
<b>SIGNUM</b>							
 (  ) → 48999999 Except 2.0T, 3.0V6, OPC, (SS) Except 	03 » 08.04	545609G L 545600G R	545609 L 545600 R	JF	(2) 115685G	(2) 115685	SC
 (  ) 51000001 → Except 2.0T, 3.0V6, OPC, (SS) Except 	09.04 »	545739G L 545730G R	545739 L 545730 R	JF	(2) 115685G	(2) 115685	SC
<b>OPEL TIGRA</b>							
<b>TIGRA</b>							
	93 »	545179G	545179	JF	254995G	254995	GC
<b>TIGRA TWIN TOP</b>							
	04 »	545568G	545568	JF			
<b>OPEL VECTRA</b>							
<b>VECTRA A</b>							
   Liftback   Except 2.0 16V, 2.5 V6	88 » 09.95	444056G	444056	FU	155149G	155149	SC
   Liftback  2.0 16V (  ) → N...	88 » 92	445272G	445272	FU	155131G	155131	SC
   Liftback  2.0 16V (  ) P... →	93 » 09.95	445272G	445272	FU	155131G	155131	SC
   Liftback  2.5 V6	88 » 09.95	445272G	445272	FU	155131G	155131	SC
   Liftback  Except Turbo	89 » 09.95	445272G	445272	FU	155131G	155131	SC





MODELE MODEL	ANNEE / YEAR						
		AVANT / FRONT			ARRIÈRE / REAR		
		GAZ / GAS	HYD	TYPE	GAZ / GAS	HYD	TYPE
<b>VECTRA B</b>							
  → T1086823 ou/or  T5106453 ou/or  T7534368  Except 2.5V6	10.95 » 11.96	545278G L 545279G R	545278 L 545279 R	JF	355270G	355270	SR
  → T1086823 ou/or  T5106453 ou/or  T7534368 2.5V6	10.95 » 11.96				355270G	355270	SR
  T1086824 ou/or  T5106454 ou/or  T7534369 →  Except 2.2 Dti, 2.5, 2.6, 3.2, 	96 » 04.02	545278G L 545279G R	545278 L 545279 R	JF	355281G	355281	SR
  T1086824 ou/or  T5106454 ou/or  T7534369 → 2.2 DTi, 2.5, 2.6	12.96 » 03.02				355281G	355281	SR
 Except 2.2DTi, 2.5, 2.6, 	10.95 » 06.03	545278G L 545279G R	545278 L 545279 R	JF	355281G <sup>(2)</sup>	355281 <sup>(2)</sup>	SR
 2.2DTi, 2.5, 2.6	10.95 » 06.03				355281G <sup>(2)</sup>	355281 <sup>(2)</sup>	SR
<b>VECTRA C</b>							
  (GTS inclus.)  → 48999999 Except 3.0V6, OPC,  Except 	04.02 » 08.04	545609G L 545600G R	545609 L 545600 R	JF	115685G <sup>(2)</sup>	115685 <sup>(2)</sup>	SC
Berline/Saloon (GTS inclus.)   51000001 → Except 2.0T, 3.0V6, OPC,  Except 	09.04 »	545739G L 545730G R	545739 L 545730 R	JF	115685G <sup>(2)</sup>	115685 <sup>(2)</sup>	SC
  51000001 → 2.0T, 3.0V6 Except OPC,  Except 	09.04 »			JF	115685G <sup>(2)</sup>	115685 <sup>(2)</sup>	SC





MODELE MODEL	ANNEE / YEAR						
		AVANT / FRONT			ARRIÈRE / REAR		
		GAZ / GAS	HYD	TYPE	GAZ / GAS	HYD	TYPE
<b>VECTRA C</b>							
  → 48999999 Except 3.0V6, OPC, (SS) Except 	07.03 » 08.04	545609G L 545600G R	545609 L 545600 R	JF	(2) 115685G	(2) 115685	SC
  51000001 → Except 2.0T, 3.0V6, OPC, (SS) Except 	09.04 »	545739G L 545730G R	545739 L 545730 R	JF	(2) 115685G	(2) 115685	SC
  51000001 → 2.0T, 3.0V6 Except OPC, (SS) Except 	09.04 »			JF	(2) 115685G	(2) 115685	SC
<b>OPEL VIVARO</b>							
<b>VIVARO</b>							
(J7) 	01 » 05.14	545593G	545593	JF	215597G	215597	GC
(F7) 	01 » 05.14	545593G	545593	JF	215597G	215597	GC
(E7) 	01 » 05.14	545593G	545593	JF	215597G	215597	GC
<b>OPEL VIVRO II</b>							
<b>VIVARO 2</b>							
	06.16 »				215597G	215597	GC
	06.16 »				215597G	215597	GC
	06.16 »				215597G	215597	GC
<b>OPEL ZAFIRA</b>							
<b>ZAFIRA I</b>							
(F75)  Except OPC, CNG	99 » 05.05	545552G L 545553G R	545552 L 545553 R	JF	115555G	115555	SC
<b>ZAFIRA II</b>							
(A05)  Except OPC, IDS	06.05 » 08.11	545716G L 545717G R	545716 L 545717 R	JF	115535G	115535	SC
<b>ZAFIRA III COMPACT</b>							
(A05)  Except OPC	09.11 »	545716G L 545717G R	545716 L 545717 R	JF	115535G	115535	SC



PANHARD



















PEUGEOT

MODELE MODEL	ANNEE / YEAR						
		AVANT / FRONT			ARRIÈRE / REAR		
		GAZ / GAS	HYD	TYPE	GAZ / GAS	HYD	TYPE

## PANHARD

24							
BA - BT - CT	64 » 68		101130	SC		151137	SC
DYNA							
PL 17, Tigre	57 » 65		101130	SC		151137	SC

















## PEUGEOT

PEUGEOT 104 Berline/Saloon							
104							
(AO1)  L, GL  → 5132735	73 » 74		444193	FU	354194G	354194	SR
(AO1)  L, GL  5132736  → 5534418	74 » 08.76		444193	FU	354504G	354504	SR
(AO1)  GL 5, GL 6  → 7070747	74 » 08.76		444193	FU	354504G	354504	SR
(AO1)  GL  5534419  → 5675804	09.76 » 02.79		444193	FU	354627G	354627	SR
(A11)  GL 6, SL  7070748  → 7182579	09.76 » 02.79		444193	FU	354627G	354627	SR
(AO1, A41)  L, GL  5675805 →	03.79 » 85	444796G	444796	FU	354627G	354627	SR
(A11)  GL6, SL  7182580 →	03.79 » 85	444796G	444796	FU	354627G	354627	SR
(A11)  GR	03.79 » 85	444796G	444796	FU	354627G	354627	SR

































MODELE MODEL	ANNEE / YEAR	AVANT / FRONT			ARRIÈRE / REAR		
		GAZ / GAS	HYD	TYPE	GAZ / GAS	HYD	TYPE
		<b>104</b>					
(A12, A31) S → 5852871	03.79 » 80	444796G	444796	FU	(1) 354627G	(1) 354627	SR
(A21) SR	03.79 » 85	444796G	444796	FU	(1) 354627G	(1) 354627	SR
SUNDGAU	03.79 » 81	444796G	444796	FU	(1) 354627G	(1) 354627	SR
GL 6 Export 5675806  → 5852671	80 » 88	544819G	544819	JF	(1) 354627G	(1) 354627	SR
(A17) GLS	80 » 88	544819G	544819	JF	(1) 354627G	(1) 354627	SR
(A 31) S 5852872 →	80 » 88	544819G	544819	JF	(1) 354627G	(1) 354627	SR
<b>PEUGEOT 104 Coupé</b>							
<b>104</b>							
(CO1) ZL → 5534418	74 » 77		444193	FU	(1) 354194	(1) 354194	SR
(C12) ZS → 5534418	74 » 77		444193	FU	(1) 354194	(1) 354194	SR
(SO1) ZA 5534419  → 5684441	77 » 03.78		444193	FU	(1) 354580G	(1) 354580	SR
(CO1) ZL 5534419  → 5684483	77 » 03.78		444193	FU	(1) 354580G	(1) 354580	SR
(C12) ZS 5534419  → 5684067	77 » 03.78		444193	FU	(1) 354580G	(1) 354580	SR























MODELE MODEL	ANNEE / YEAR						
		AVANT / FRONT			ARRIÈRE / REAR		
		GAZ / GAS	HYD	TYPE	GAZ / GAS	HYD	TYPE
<b>104</b>							
(S11)  Z  5684068 →	04.78 » 88	544819G	544819	JF	<sup>(1)</sup> 354580G	<sup>(1)</sup> 354580	SR
(S11)  ZA  5684442 →	04.78 » 88	544819G	544819	JF	<sup>(1)</sup> 354580G	<sup>(1)</sup> 354580	SR
(C11)  ZL  5684484 →	04.78 » 88	544819G	544819	JF	<sup>(1)</sup> 354580G	<sup>(1)</sup> 354580	SR
 ZR - Style Z	04.78 » 88	544819G	544819	JF	<sup>(1)</sup> 354580G	<sup>(1)</sup> 354580	SR
(C 31)  ZS,104 ZS 2  5684068 →	04.78 » 88	544819G	544819	JF	<sup>(1)</sup> 354580G	<sup>(1)</sup> 354580	SR
<b>PEUGEOT 106</b>							
<b>106</b>							
 954cc, 1124cc, 1360D Except Commerciale/Affaires	91 »	445159G	445159	FU	215161G	215161	SC
954cc, 1124cc (+) Commerciale/Affaires (XA, XAD)	91 »	445159G	445159	FU	215161G	215161	GC
1294cc (Rallye inclus) 1527cc (Diesel inclus) 1587cc (XS, XSi, S16, Rallye inclus)	91 »	445159G	445159	FU	215161G	215161	GC
1360cc XSi	91 »	445159G	445159	FU	215162G	215162	GC
<b>PEUGEOT 107</b>							
<b>107</b>							
  05 »		545696G L 545697G R	545696 L 545697 R	JF	155698G	155698	SC
<b>PEUGEOT 204</b>							
<b>204</b>							
L   → 6077324	65 » 01.70		441775	FU		351717	SR



















MODELE MODEL	ANNEE / YEAR						
		AVANT / FRONT			ARRIÈRE / REAR		
		GAZ / GAS	HYD	TYPE	GAZ / GAS	HYD	TYPE
<b>204</b>							
GL  (  ) → 8792449	65 » 01.70		441775	FU		351717	SR
L  (  ) 6077325 →	02.70 » 08.74		441979	FU		351717	SR
GL  (  ) 8792450 (  ) → 9064000	02.70 » 08.74		441979	FU		351717	SR
GL  (  ) 9064001 → Bras de suspension arrière traversée/ Rear lower extension rod	09.74 » 76		441979	FU		354150	SR
 (  ) 6472501 (  ) → 6491074	65 » 01.70		441775	FU		351713	SR
 (  ) 6491075 →	02.70 » 76			FU		351717	SR
 (  ) 6414001 (  ) → 6419398	65 » 01.70		441775	FU		351713	SR
 (  ) 6419399 →	02.70 » 76		441979	FU		351717	SR
 Essence/Petrol (  ) → 7507795	65 » 01.70		441775	FU		351717	SR
 Diesel (  ) → 7900206	65 » 01.70		441775	FU		351717	SR
 Essence/Petrol (  ) 7507796 (  ) → 7602616	02.70 » 08.74		441979	FU		351717	SR
 Diesel (  ) 7900207 (  ) → 7940703	02.70 » 08.74		441979	FU		351717	SR
 Essence/Petrol : (  ) 7602617 → Bras de suspension arrière traversée/ Rear lower extension rod	09.74 » 76		441979	FU		354150	SR

















MODELE MODEL	ANNEE / YEAR						
		AVANT / FRONT			ARRIÈRE / REAR		
		GAZ / GAS	HYD	TYPE	GAZ / GAS	HYD	TYPE
<b>204</b>							
 Diesel :  7940704 → Bras de suspension arrière traversée/ Rear lower extension rod	09.74 » 76		441979	FU		354150	SR
(U4)   → 6504234	65 » 01.70		441775	FU		351717	SR
(U4)   6504235  → 6512494	02.70 » 08.74		441979	FU		351717	SR
(U4)   6512495 →	09.74 » 76		441979	FU		354150	SR
(U4)  Diesel Bras de suspension arrière traversée/ Rear lower extension rod	09.74 » 76		441979	FU		354150	SR
<b>PEUGEOT 205</b>							
<b>205</b>							
  Essence/Petrol Except GT, GTi, SR, XS, XT, <b>A</b> , Gentry, Rallye, Style	82 »	544941G	544941	JF	114942G	114942	SC
 Essence/Petrol GT, SR, XS, XT, <b>A</b> , Style (Except GTi)	82 »	544941G	544941	JF	214940G	214940	GC
 Essence/Petrol GTi, Gentry, Rallye	83 »	544948G L 544949G R	544948 L 544949 R	JF	214940G	214940	GC
 Diesel Except Turbo Diesel	82 »	544941G	544941	JF	214940G	214940	GC
 Turbo Diesel	83 »	544948G L 544949G R	544948 L 544949 R	JF	214940G	214940	GC
 CT, CJ, (Except CTi)	85 »	544941G	544941	JF	214940G	214940	GC
 CTi	85 »	544053G <sup>(2)</sup>	544053 <sup>(2)</sup>	JF	214940G	214940	GC















MODELE MODEL	ANNEE / YEAR						
		AVANT / FRONT			ARRIÈRE / REAR		
		GAZ / GAS	HYD	TYPE	GAZ / GAS	HYD	TYPE
<b>205</b>							
Commerciale (XA, XAD)	82 »	544941G	544941	JF	214940G	214940	GC
<b>205 F</b>							
	94 »	544053G <sup>(2)</sup>	544053 <sup>(2)</sup>	JF	214940G	214940	GC
<b>PEUGEOT 206</b>							
<b>206</b>							
(2A, 2C)  1.1 8V Except 	98 »	545469G L 545460G R	545469 L 545460 R	JF	215484G	215484	GC
(2A, 2C)  1.4 (8, 16V), 1.4HDi, 1.6 (8, 16V), 1.6HDi, 1.9D Except S16, XS, XT Except 	98 »	545469G L 545460G R	545469 L 545460 R	JF	215485G	215485	GC
(2A, 2C)  1.4 6V XT, 1.4HDi XT, 1.6 16V XS, 1.6 16V XT, 1.6HDi S16, 2.0 S16 (16V inclus) Except 	98 »	545482G L 545483G R	545482 L 545483 R	JF	215486G	215486	GC
(2A, 2C)  2.0 TD, 2.0 HDi (XT inclus) Except 	98 »	545482G L 545483G R	545482 L 545483 R	JF	215485G	215485	GC
<b>206 +</b>							
(2A, 2C)  1.1, 1.4, 1.4HDi	03.09 »	545482G L 545483G R	545482 L 545483 R	JF	215485G	215485	GC
<b>206 CC</b>							
(2D)  1.6 16V, 1.6HDi, 2.0 16 V Except 	00 »	545482G L 545483G R	545482 L 545483 R	JF	215486G	215486	GC
<b>206 SW</b>							
(2E, 2K)  1.1, 1.4, 1.4HDi Except 	02 »	545469G L 545460G R	545469 L 545460 R	JF	215486G	215486	GC















MODELE MODEL	ANNEE / YEAR						
		AVANT / FRONT			ARRIÈRE / REAR		
		GAZ / GAS	HYD	TYPE	GAZ / GAS	HYD	TYPE
<b>206 SW</b>							
(2E, 2K)  1.6 16V, 1.6Hdi, 2.0 S16 (16V), 2.0 HDi Except 	02 »	545482G L 545483G R	545482 L 545483 R	JF	215486G	215486	GC
<b>206 ENTREPRISE</b>							
(2S) Commerciale/Affaires/Entreprise (XA, XAD) Except 	98 »	545469G L 545460G R	545469 L 545460 R	JF	215485G	215485	GC
<b>206 SEDAN</b>							
	05 »	545482G L 545483G R	545482 L 545483 R	JF	215486G	215486	GC
<b>PEUGEOT 207</b>							
<b>207</b>							
(WA, WC)  1.4, 1.4 16V Except VTI Except  Ø Intérieur pivot/Hub internal Ø = 47 mm	(4) 06 »	(3) 545771G L 545772G R	(3) 545771 L 545772 R	JF	215601G	215601	GC
(WA, WC)  1.4Hdi : Orga. N° → 10933 Except  Ø Intérieur pivot/Hub internal Ø = 51 mm	(4) 06 »	(3) 545607G L 545608G R	(3) 545607 L 545608 R	JF	215601G	215601	GC
(WA, WC)  1.4Hdi : Orga. N° → 10934 > 11500 Except  Ø Intérieur pivot/Hub internal Ø = 47 mm ou/or Ø Intérieur pivot/Hub internal Ø = 51 mm	(4) 06 »	(3) 545607G L 545608G R ou/or 545771G L 545772G R	(3) 545607 L 545608 R ou/or 545771 L 545772 R	JF	215601G	215601	GC
(WA, WC)  1.4Hdi : Orga. N° 11501 → Except  Ø Intérieur pivot/Hub internal Ø = 47 mm	(4) 06 »	(3) 545771G L 545772G R	(3) 545771 L 545772 R	JF	215601G	215601	GC

























MODELE MODEL	ANNEE / YEAR						
		AVANT / FRONT			ARRIÈRE / REAR		
		GAZ / GAS	HYD	TYPE	GAZ / GAS	HYD	TYPE
<b>207</b>							
(WA, WC)  1.6 16V, 1.6HDi, Except 1.6 16V Turbo, VTI, THP, RC Except  Ø Intérieur pivot/Hub internal Ø = 51 mm	(4) 06 »	(3) 545607G L 545608G R	(3) 545607 L 545608 R	JF	215601G	215601	GC
(WA, WC)  1.6 16V : Turbo, VTI, RC Except THP Except  Ø Intérieur pivot/Hub internal Ø = 51 mm	(4) 06 »	(3) 545607G L 545608G R	(3) 545607 L 545608 R	JF	215601G	215601	GC
<b>207 +</b>							
 1.4, 1,4 Hdi	(4) 11.12 »	(3) 545607G L 545608G R ou/or 545771G L 545772G R	(3) 545607 L 545608 R ou/or 545771 L 545772 R	JF	215601G	215601	GC
<b>207 CC</b>							
(WD)  1.6 16V, 1.6HDi Except 1.6 16V Turbo, VTI, THP, RC Except  Ø Intérieur pivot/Hub internal Ø = 51 mm	(4) 06 »	(3) 545607G L 545608G R	(3) 545607 L 545608 R	JF	215601G	215601	GC
(WD)  1.6 16V, 1.6HDi 1.6 16V : Turbo, VTI, RC Except THP Except  Ø Intérieur pivot/Hub internal Ø = 51 mm	(4) 06 »	(3) 545607G L 545608G R	(3) 545607 L 545608 R	JF			
<b>207 SW</b>							
(WK)  1.4, 1,4 16V Except VTI, RC, Outdoor Except  Ø Intérieur pivot/Hub internal Ø = 47 mm	(4) 07 »	(3) 545771G L 545772G R	(3) 545771 L 545772 R	JF	215601G	215601	GC

























MODELE MODEL	ANNEE / YEAR						
		AVANT / FRONT			ARRIÈRE / REAR		
		GAZ / GAS	HYD	TYPE	GAZ / GAS	HYD	TYPE
<b>207 SW</b>							
(WK)  1.6 16V, 1.6HDi, Except 1.6 16V VTI, THP, RC, Outdoor Except  Ø Intérieur pivot/Hub internal Ø = 51 mm	(4) 07 »	(3) 545607G L 545608G R	(3) 545607 L 545608 R	JF	215601G	215601	GC
(WK)  1.6 16V RC Except 1.6 16V VTI, THP, Outdoor Except  Ø Intérieur pivot/Hub internal Ø = 51 mm	(4) 06 »	(3) 545607G L 545608G R	(3) 545607 L 545608 R	JF			
<b>207 Utilitaire / Commercial</b>							
Commercial/Affaires/Entreprise 1.4HDi, 1.6HDi	(4) 11.12 »	(3) 545607G L 545608G R ou/or 545771G L 545772G R	(3) 545607 L 545608 R ou/or 545771 L 545772 R	JF	215601G	215601	GC
<b>207 Utilitaire / Commercia</b>							
	(4) 07 »	(3) 545607G L 545608G R	(3) 545607 L 545608 R	JF	215601G	215601	GC
<b>PEUGEOT 208</b>							
<b>208</b>							
 Esence/Petrol 1.0, 1.2, 1.4, Except GTi Ø Intérieur pivot/Hub internal Ø = 47 mm ou/or Ø Intérieur pivot/Hub internal Ø = 51 mm	12 »	545881G L 545882G R ou/or 545883G L 545884G R	545881 L 545882 R ou/or 545883 L 545884 R	JF	215885G	215885	GC
 Esence/Petrol :1.6, Except GTi Diesel: 1.4HDi, 1.6HDi Ø Intérieur pivot/Hub internal Ø = 47 mm ou/or Ø Intérieur pivot/Hub internal Ø = 51 mm	12 »	545881G L 545882G R ou/or 545883G L 545884G R	545881 L 545882 R ou/or 545883 L 545884 R	JF	215886G	215886	GC
<b>PEUGEOT 301</b>							
<b>301</b>							
 	12 »	545912G L 545913G L	545912 L 545913 L	JF	115916G	115916	GC



MODELE MODEL	ANNEE / YEAR						
		AVANT / FRONT			ARRIÈRE / REAR		
		GAZ / GAS	HYD	TYPE	GAZ / GAS	HYD	TYPE
<b>PEUGEOT 304</b>							
<b>304</b>							
(A01)  (  ) → 3015671	09.69 » 01.70		441775	FU		351717	SR
(A01)  (  ) 3015672 (  ) → 3365000	02.70 » 08.72		441979	FU		351717	SR
S  (  ) → 3365000	02.70 » 08.72		441979	FU		351717	SR
(M01, M02)  (  ) 3365001 (  ) → 4031500 Bras de suspension arrière traversée/ Rear lower extension rod	09.72 » 08.77		441979	FU		354150	SR
(M01, M02)  (  ) 4031501 → Bras de suspension arrière traversée/ Rear lower extension rod	09.77 »	444507G	444507	FU	354619G	354619	SR
(D11)  Diesel (  ) 4031501 → Bras de suspension arrière traversée/ Rear lower extension rod	09.77 »	444507G	444507	FU	354619G	354619	SR
(C01)  (S Inclus) (  ) → 3298000	02.70 » 08.72		441979	FU		351717	SR
(C01)  (S Inclus) (  ) 3298001 → Bras de suspension arrière traversée/ Rear lower extension	09.72 »		441979	FU		354150	SR
(B01)  (  ) → 3296250	02.70 » 08.72		441979	FU		351717	SR























MODELE MODEL	ANNEE / YEAR						
		AVANT / FRONT			ARRIÈRE / REAR		
		GAZ / GAS	HYD	TYPE	GAZ / GAS	HYD	TYPE
<b>304</b>							
(B01)  (  ) 3296251 (  ) → 4031500 Bras de suspension arrière traversée/ Rear lower extension	09.72 » 08.77		441979	FU		354150	SR
(B02)  (  ) 3298001 (  ) → 4031500 Bras de suspension arrière traversée/ Rear lower extension	09.72 » 08.77		441979	FU		354150	SR
(D01)  (  ) → 3615855	02.70 » 08.72		441979	FU		351717	SR
(D01)  (  ) 3615856 (  ) → 4031500 Bras de suspension arrière traversée/ Rear lower extension	09.72 » 08.77		441979	FU		354150	SR
(M20)  (  ) 4031501 → Bras de suspension arrière traversée/ Rear lower extension	09.77 »	444507G	444507	FU	354619G	354619	SR
(D01, D20)  Diesel (  ) 4031501 → Bras de suspension arrière traversée/ Rear lower extension rod	09.77 »	444507G	444507	FU	354619G	354619	SR
(T20)  Bras de suspension arrière traversée/ Rear lower extension rod	09.72 »		441979	FU		354150	SR
<b>PEUGEOT 305</b>							
<b>305</b>							
 (  ) → 8870212 GL, GLS, GR, SR, S, GLD, GRD, SRD	77 » 82	444507G	444507	FU	354508G	354508	SR
 (  ) 8870213 (  ) → 8987000 GL, GLS, GR, SR, S, GLD, GRD, SRD	82 » 06.82	444507G	444507	FU	354918G	354918	SR





















MODELE MODEL	ANNEE / YEAR						
		AVANT / FRONT			ARRIÈRE / REAR		
		GAZ / GAS	HYD	TYPE	GAZ / GAS	HYD	TYPE
<b>305</b>							
 (  ) → 8987000	78 » 06.82	444507G	444507	FU	355111G	355111	SR
 (  ) 89870001 →	07.82 » 89	544911G	544911	JF	355111G	355111	SR
<b>305 Serie II</b>							
 GL, GLS (  ) 8987001 (  ) → 9370000	07.82 » 86	544911G	544911	JF	354918G	354918	SR
 GR, SR (  ) 8987001 (  ) → 9524000	07.82 » 86	544911G	544911	JF	354918G	354918	SR
 S, GLD, GRD, SRD (  ) 8987001 →	07.82 » 88	544911G	544911	JF	354918G	354918	SR
 <b>A</b>	86 » 88	544911G	544911	JF	354985G	354985	SR
 GL (  ) 9370001 →	86 » 88	544911G	544911	JF	354985G	354985	SR
 GR, SR (  ) 9524001 →	86 » 88	544911G	544911	JF	354985G	354985	SR
 GT, GTX	83 » 88	544911G	544911	JF	354985G	354985	SR
<b>PEUGEOT 306</b>							
<b>306</b>							
(7A, 7B, 7C)  1124cc, 1360cc Except 	93 » 02.97	545280G L 545291G R	545280 L 545291 R	JF	114942G	114942	SC
(7A, 7B, 7C)  1587cc, 1769cc (D) Except 	93 » 02.97	545280G L 545291G R	545280 L 545291 R	JF	214940G	214940	GC
(7A, 7B, 7C)  1761cc, 1905cc (D, TD) 1998cc (XSi, 16V inclus.) Except 	93 » 02.97	<sup>(6)</sup> 545293G L 545294G R	<sup>(6)</sup> 545293 L 545294 R	JF	214940G	214940	GC













MODELE MODEL	ANNEE / YEAR						
		AVANT / FRONT			ARRIÈRE / REAR		
		GAZ / GAS	HYD	TYPE	GAZ / GAS	HYD	TYPE
<b>306</b>							
(7A, 7B, 7C)  1.4 Except 	03.97 »	545280G L 545291G R	545280 L 545291 R	JF	114942G	114942	SC
(7A, 7B, 7C)  1.6, 1.7 D Except 	03.97 »	545280G L 545291G R	545280 L 545291 R	JF	214940G	214940	GC
(7A, 7B, 7C)  1.8, 1.9 D, TD, 2.0 (Except S16) 2.0 D, 2.0 HDi Except 	03.97 »	545293G L 545294G R	545293 L 545294 R	JF	214940G	214940	GC
(7D)  	93 »	545293G L <sup>(6)</sup> 545294G R	545293 L <sup>(6)</sup> 545294 R	JF	214940G	214940	GC
(7D)   Except BA100	03.97 »	545293G L <sup>(6)</sup> 545294G R	545293 L <sup>(6)</sup> 545294 R	JF	214940G	214940	GC
(7E)   Commerciale/Affaires (XA, XAD) Except 	03.97 »	545293G L 545294G R	545293 L 545294 R	JF	214940G	214940	GC
<b>306 SEDAN</b>							
 	93 »	545163G L 545164G R	545163 L 545164 R	JF	214940G	214940	GC
<b>PEUGEOT 307</b>							
<b>307</b>							
(3A, 3C)   Except 	01 »	545594G L 545595G R	545594 L 545595 R	JF	255596G	255596	GC
(3A, 3C)   (+) 	01 »	545508G L 545509G R	545508 L 545509 R	JF	255615G	255615	GC
<b>307 CC</b>							
(3B)  	03 »	545594G L 545595G R	545594 L 545595 R	JF	255500G	255500	GC
<b>307 SW</b>							
(3E, 3H)   Except 	02 »	545594G L 545595G R	545594 L 545595 R	JF	255500G	255500	GC

























MODELE MODEL	ANNEE / YEAR						
		AVANT / FRONT			ARRIÈRE / REAR		
		GAZ / GAS	HYD	TYPE	GAZ / GAS	HYD	TYPE
<b>307 SW</b>							
(3E, 3H)  (+) 	02 »	545508G L 545509G R	545508 L 545509 R	JF	255615G	255615	GC
<b>PEUGEOT 308</b>							
<b>308</b>							
 Except GTI Except 	07 » 08.13	545786G L 545787G R	545786 L 545787 R	JF	255788G	255788	GC
 GTI Except 	07 » 08.13	545786G L 545787G R	545786 L 545787 R	JF	255500G	255500	GC
<b>308 II</b>							
 Except GTI Except 	09.13 »	545922G	545922	JF	755923G	755923	PLL
<b>308 CC</b>							
 Except  , RCZ	09 »	545786G L 545787G R	545786 L 545787 R	JF	255500G	255500	GC
<b>308 SW I</b>							
 Except 	08 » 12.13	545786G L 545787G R	545786 L 545787 R	JF	255615G	255615	GC
<b>308 SW II</b>							
 Except 	01.14 »				755923G	755923	PLL
<b>PEUGEOT 309</b>							
<b>309</b>							
 Except GR, GT, GTi, SR, XR Except  , Diesel, Turbo D	85 »	544053G <sup>(2)</sup>	544053 <sup>(2)</sup>	JF	114942G	114942	SC
GR, GT (Except GTi)	85 »	544053G <sup>(2)</sup>	544053 <sup>(2)</sup>	JF	214940G	214940	GC
SR, SX (Except Type 3AD2A2)	85 »	544053G <sup>(2)</sup>	544053 <sup>(2)</sup>	JF	214940G	214940	GC
XR, XS (Except Type 3CD2A2)	85 »	544053G <sup>(2)</sup>	544053 <sup>(2)</sup>	JF	214940G	214940	GC
 Diesel (Except Turbo D)	85 »	544053G <sup>(2)</sup>	544053 <sup>(2)</sup>	JF	214940G	214940	GC
GTi (16V inclus), SX Type 3AD2A2 XS Type 3CD2A2, Turbo Diesel	86 »	544948G L 544949G R	544948 L 544949 R	JF	214940G	214940	GC



































MODELE MODEL	ANNEE / YEAR						
		AVANT / FRONT			ARRIÈRE / REAR		
		GAZ / GAS	HYD	TYPE	GAZ / GAS	HYD	TYPE
<b>PEUGEOT 403</b>							
<b>403</b>							
 Except 	60 » 65					171159	SC
 B8, B8 D	60 » 67					211187	GC
<b>PEUGEOT 404</b>							
<b>404</b>							
  	60 » 09.65		441740	FU		271675	GC
  	10.65 » 76		441977	FU		271675	GC
L, LD, U6, U6 D 	60 » 03.64		441740	FU			
L  (F+D) → 4847246	04.64 » 08.65		441740	FU		211565	GC
LD  (F+D) → 4979373	04.64 » 08.65		441740	FU		211565	GC
U6  (F+D) → 4733915	04.64 » 08.65		441740	FU		211565	GC
U6 D  (F+D) → 4906964	04.64 » 08.65		441740	FU		211565	GC
L  (F+D) 4847247 →	09.65 »		441977	FU		211565	GC
LD  (F+D) 4979374 →	09.65 »		441977	FU		211565	GC
U6  (F+D) 4733916 →	09.65 »		441977	FU		211565	GC
U6 D  (F+D) 4906965 →	09.65 »		441977	FU		211565	GC
 U8, U8 D, U10, U10 D	67 »		441977	FU		211187	GC

























MODELE MODEL	ANNEE / YEAR						
		AVANT / FRONT			ARRIÈRE / REAR		
		GAZ / GAS	HYD	TYPE	GAZ / GAS	HYD	TYPE
<b>PEUGEOT 405</b>							
<b>405</b>							
 Except GRi, Mi 16, SRi, STi	87 »	544020G	544020	JF	214031G	214031	GC
 T16	89 »	545214G	545214	JF			
<b>PEUGEOT 406</b>							
<b>406</b>							
(8B)  Except 	<sup>(7)</sup> 95 »	545314G L 545315G R	545314 L 545315 R	JF	255316G	255316	GC
(8C)  Except 	<sup>(7)</sup> 96 »	545314G L 545315G R	545314 L 545315 R	JF	255478G	255478	GC
(8E, 8F)  Except 	<sup>(7)</sup> 96 »	545314G L 545315G R	545314 L 545315 R	JF	255317G	255317	GC
<b>PEUGEOT 407</b>							
<b>407</b>							
 Except 3.0 V6 (24V) Except 	<sup>(7)</sup> 04 »	345679G	345679	SR	355670G	355670	SR
<b>407 SW</b>							
 Except 3.0 V6 (24V) Except 	<sup>(7)</sup> 04 »	345679G	345679	SR	355670G	355670	SR
<b>PEUGEOT 504</b>							
<b>504</b>							
 GL, GLD, Ti  → 2181356	68 » 03.76		441838	FU	254484G	254484	GC
  → 2085065	68 » 03.76		441838	FU	254484G	254484	GC
 GL, GLD, Ti  2181357 →	04.76 »	444444G	444444	FU	254484G	254484	GC
  2085066 →	04.76 »	444444G	444444	FU	254484G	254484	GC















MODELE MODEL	ANNEE / YEAR						
		AVANT / FRONT			ARRIÈRE / REAR		
		GAZ / GAS	HYD	TYPE	GAZ / GAS	HYD	TYPE
<b>504</b>							
 L, LD  → 2181356 Pont rigide/Rigid Axle	73 » 03.76		441838	FU		271675	GC
 L, LD  2181357 → Pont rigide/Rigid Axle	04.76 » 03.76	444444G	444444	FU	214875G	214875	GC
 GR, GRD, SR, SRD Pont rigide/Rigid Axle	76 »	444444G	444444	FU	214875G	214875	GC
  L, LD, GL, GLD  → 2181356	71 »		441838	FU	211096	211096	GC
  L, LD, GL, GLD  2181357 →	04.76 »	444444G	444444	FU	211096G	211096	GC
  GR, GRD	76 »	444444G	444444	FU	211096G	211096	GC
  U01, U20, V20  → 3610000	79 » 08.81		444877	FU		211187	GC
  U01, U20, V20  3610001 →	09.81 »		444024	FU		211187	GC
  Dangel	82 »					211187	GC
<b>PEUGEOT 505</b>							
<b>505</b>							
   → 1845000 Except Turbo Injection	79 » 85	444444G	444444	FU	254484G	254484	GC
   1845001 → Except Turbo Injection, V6	86 »	444996G	444996	FU	254484G	254484	GC
 Turbo Injection  → 1887750	84 » 85	444444G	444444	FU	254484G	254484	GC































MODELE MODEL	ANNEE / YEAR						
		AVANT / FRONT			ARRIÈRE / REAR		
		GAZ / GAS	HYD	TYPE	GAZ / GAS	HYD	TYPE
<b>505</b>							
 Turbo Injection (  ) 1887751 → Except ABS	86 »	444996G	444996	FU	254484G	254484	GC
 Turbo Injection ABS, V6	87 »				254484G	254484	GC
  (  ) → 1845000	82 » 85	444444G	444444	FU	214875G	214875	GC
  (  ) 1845001 →	86 »	444996G	444996	FU	214875G	214875	GC
<b>PEUGEOT 508</b>							
<b>508</b>							
 Except 2.2 HDi, Hybrid 4	10 »				355670G	355670	SR
 2.2 HDi Except Hybrid 4	10 »	345679G	345679	SR	355670G	355670	SR
<b>508 SW</b>							
 Except 2.2 HDi, RXH, Hybrid 4	10 »				355670G	355670	SR
 2.2 HDi Except RXH, Hybrid 4	10 »	345679G	345679	SR	355670G	355670	SR
<b>PEUGEOT 604</b>							
<b>604</b>							
 	74 » 86	444444G	444444	FU	254484G	254484	GC
<b>PEUGEOT 605</b>							
<b>605</b>							
  <sup>(7)</sup>	89 » 06.94	545123G L 545122G R	545123 L 545122 R	JF	215124G	215124	GC
  <sup>(7)</sup>	07.94 »	545349G L 545340G R	545349 L 545340 R	JF	215124G	215124	GC
<b>PEUGEOT 607</b>							
<b>607</b>							
(9D, 9U)  Except 3.0 V6 <sup>(7)</sup>	00 »	545795G L 545795G R	545795 L 545796 R	JF	215797G	215797	GC





























MODELE MODEL	ANNEE / YEAR						
		AVANT / FRONT			ARRIÈRE / REAR		
		GAZ / GAS	HYD	TYPE	GAZ / GAS	HYD	TYPE
<b>PEUGEOT 806</b>							
<b>806</b>							
(221)  → N° 7609	94 » 07.97	545284G	545284	JF	<sup>(9)</sup> 215245G	<sup>(9)</sup> 215245	GC
(221)  N° 7610 →	08.97 »	545284G	545284	JF	<sup>(9)</sup> 215468G	<sup>(9)</sup> 215468	GC
<b>PEUGEOT 807</b>							
<b>807</b>							
(E) 	02 »	545676G L 545677G R	545676 L 545677 R	JF	215678G	215678	GC
<b>PEUGEOT 1007</b>							
<b>1007</b>							
 (2-Tronic inclus.) Except 1.6 RC	05 »	545580G L 545591G R	545580 L 545591 R	JF	115592G	115592	SC
<b>PEUGEOT 2008</b>							
<b>2008</b>							
 Ø = 47	13 »	545948G L 545949G R	545948 L 545949 R	JF	115952G	115952	SC
 Ø = 51	13 »	545940G L 545951G R	545940 L 545951 R	JF	115952G	115952	SC
<b>PEUGEOT 3008</b>							
<b>3008</b>							
5/7 Sièges/Seats  Except System REAS, Hybrid 4	09 »	545816G L 545817G R	545816 L 545817 R	JF	255818G	255818	GC
<b>PEUGEOT 5008</b>							
<b>5008</b>							
	09 »	545829G L 545820G R	545829 L 545820 R	JF	215831G	215831	GC
<b>PEUGEOT BIPPER</b>							
<b>BIPPER</b>							
	07 »	545603G L 545604G R	545603 L 545604 R	JF	115752G	115752	SC
<b>BIPPER TEPEE</b>							
	09 »	545603G L 545604G R	545603 L 545604 R	JF	115752G	115752	SC













MODELE MODEL	ANNEE / YEAR						
		AVANT / FRONT			ARRIÈRE / REAR		
		GAZ / GAS	HYD	TYPE	GAZ / GAS	HYD	TYPE
<b>PEUGEOT BOXER</b>							
<b>BOXER</b>							
(230, 240)  1000 <sub>kg</sub> (2.7t, 2.9t) 1400 <sub>kg</sub> (3.1t, 3.2t, 3.3t)	(10) 94 » 05.06	545263G	545263	JF	<sup>(11)</sup> 215243G	<sup>(11)</sup> 215243	GC
(230, 240)  1800 <sub>kg</sub> (35t)	(10) 94 » 05.06	545505G	545505	JF	<sup>(11)</sup> 715244G	<sup>(11)</sup> 715244	PLL
(230, 240) 	94 » 08.06	545263G	545263	JF	<sup>(11)</sup> 215243G	<sup>(11)</sup> 215243	GC
 Except 	(10) 06.06 »	545828G	545828	JF	<sup>(11) (12)</sup> 715861G	<sup>(11) (12)</sup> 715861	PLL
 Except 	(10) 06.06 »	545828G	545828	JF	<sup>(11) (12)</sup> 715862G 715863G	<sup>(11) (12)</sup> 715862 715863	PLL
 Except 	(10) 06.06 »	545830G	545830	JF	<sup>(11) (12)</sup> 715861G 715862G 715863G	<sup>(11) (12)</sup> 715861 715862 715863	PLL
<b>PEUGEOT EXPERT</b>							
<b>EXPERT</b>							
  → 7609	95 » 07.97		545289	JF	<sup>(13)</sup> 215296G	<sup>(13)</sup> 215296	GC
  7610 →	08.97 » 12.03		545289	JF	<sup>(13)</sup> 215475G	<sup>(13)</sup> 215475	GC
  9793 →	01.04 » 12.06				<sup>(13)</sup> 215475G	<sup>(13)</sup> 215475	GC
 Except  Except 	01.07 »	545804G L 545805G R	545804 L 545805 R	JF	215840G	215840	GC
 (+)  	01.07 »	545804G L 545805G R	545804 L 545805 R	JF	215851G	215851	GC
<b>EXPERT TEPEE</b>							
 (7/9 Places/Seats) Except  Except 	01.07 »	545804G L 545805G R	545804 L 545805 R	JF	215840G	215840	GC
 (7/9 Places/Seats) (+)  	01.07 »	545804G L 545805G R	545804 L 545805 R	JF	215851G	215851	GC





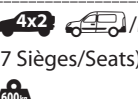
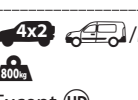

MODELE MODEL	ANNEE / YEAR						
		AVANT / FRONT			ARRIÈRE / REAR		
		GAZ / GAS	HYD	TYPE	GAZ / GAS	HYD	TYPE
<b>PEUGEOT J5 --&gt; J9</b>							
<b>J5</b>							
 → 0244300	81 » 85	544960G	544960	JF	214809G <sup>(11)</sup>	214809 <sup>(11)</sup>	GC
 0244301 → Except 	85 » 95		544040	JF	214809G <sup>(11)</sup>	214809 <sup>(11)</sup>	GC
 	85 » 95		544961		714968 <sup>(11)</sup>	714968 <sup>(11)</sup>	PLL
  → 0327500 Except 	85 » 87		544040	JF	214809G <sup>(11)</sup>	214809 <sup>(11)</sup>	GC
  0327501 → Except 	87 » 95		544040	JF	214963 <sup>(11)</sup>	214963 <sup>(11)</sup>	GC
 	85 » 95		544961	JF			
<b>J7</b>							
 	65 » 80	341073G	341073	SR	251596	251596	GC
<b>J9</b>							
  → 4161496	80 » 86	341073G	341073	SR	251596	251596	GC
  4161497 →	87 »	344093G	344093	SR	251596	251596	GC
<b>PEUGEOT P4</b>							
<b>P4</b>							
Jeep 	80 »	724866G	724866	PLL	754867G	754867	PLL
<b>PEUGEOT PARTNER , RANCH</b>							
<b>PARTNER 1 &amp; RANCH</b>							
   	96 » 03.08	545280G L 545291G R	545280 L 545291 R	JF	215292G	215292	GC









MODELE MODEL	ANNEE / YEAR						
		AVANT / FRONT			ARRIÈRE / REAR		
		GAZ / GAS	HYD	TYPE	GAZ / GAS	HYD	TYPE
<b>PARTNER 1 &amp; RANCH</b>							
 765 <sub>15</sub> 800 <sub>15</sub>	96 » 03.08	545293G L 545294G R	545293 L 545294 R	JF	215292G	215292	GC
<b>PEUGEOT PARTNER I ORIGIN, EXCEPT PARTNER II</b>							
<b>PARTNER 1 ORIGIN</b>							
 475 <sub>15</sub> 600 <sub>15</sub>	04.08 »	545280G L 545291G R	545280 L 545291 R	JF	215292G	215292	GC
 765 <sub>15</sub> 800 <sub>15</sub>	04.08 »	545293G L 545294G R	545293 L 545294 R	JF	215292G	215292	GC
<b>PEUGEOT PARTNER II, EXCEPT PARTNER I ORIGIN</b>							
<b>PARTNER 2</b>							
(B9)  600 <sub>15</sub> Except (HD)	04.08 » 08.18	545810G L 545821G R	545810 L 545821 R	JF	215871G	215871	GC
(B9)  800 <sub>15</sub> Except (HD)	04.08 » 08.18	545810G L 545821G R	545810 L 545821 R	JF	215872G	215872	GC
<b>PARTNER 2 TEPEE</b>							
 (5 Sièges/Seats) 600 <sub>15</sub> Except (HD)	04.08 » 08.18	545810G L 545821G R	545810 L 545821 R	JF	215871G	215871	GC
 (7 Sièges/Seats) 600 <sub>15</sub> Except (HD)	04.08 » 08.18	545810G L 545821G R	545810 L 545821 R	JF	215872G	215872	GC
 800 <sub>15</sub> Except (HD)	04.08 » 08.18	545810G L 545821G R	545810 L 545821 R	JF	215872G	215872	GC
<b>POLONEZ</b>							
<b>CARO &amp; CARGO</b>							
CARO, CARGO 	92 » 02.95	141601G	141601	SC	154791G	154791	SC
CARO (Except Caro Plus), CARGO 	03.95 »				154791G	154791	SC





MODELE MODEL	ANNEE / YEAR						
		AVANT / FRONT			ARRIÈRE / REAR		
		GAZ / GAS	HYD	TYPE	GAZ / GAS	HYD	TYPE
<b>FSO</b>							
Polonez 1500, 1600 	78 » 93	141601G	141601	SC	154791G	154791	SC
<b>Pick up &amp; Truck</b>							
	94 »	141601G	141601	SC	105128G	105128	SC



**POLSKI (FIAT - POLMO)**

<b>101 P</b>							
Zastava	69 »		544813	JF	554852G	554852	JF
<b>125 P</b>							
	70 » 73		141496	SC	151762G	151762	SC
	70 » 71		141496	SC	111496G	111496	SC
	72 » 73		141496	SC			
	74 » 78		141496	SC	151602G	151602	SC
<b>126 P</b>							
 Except 126 Bis	74 »	161350G	161350	SC	171361G	171361	SC
<b>127 P</b>							
	71 »	544825G	544825	JF	554851G	554851	JF
<b>132 P</b>							
	74 »	141601G	141601	SC	151801G	151801	SC

**PORSCHE**

<b>911 &amp; 912</b>							
Serie A	65 » 07.68		441776 <sup>(1)</sup>	FU		251626	GC
Serie B, C, D	08.68 » 09.71		441937 <sup>(1)</sup>	FU		251626	GC
<b>911</b>							
Serie E Avant/Front = Hydromat Suspension	68 » 09.71					251626	GC
Serie E	10.71 » 03.89		441937	FU		254106	GC
SC, TC, Carrera RS Avant/Front = Hydromat Suspension	10.71 » 05.75					254106	GC
SC, TC, Carrera, Turbo	06.75 » 03.89		441937 <sup>(1)</sup>	FU		254106	GC
<b>914</b>							
W 4, 6 Cylindres	69 » 76		441937 <sup>(1)</sup>	FU			
<b>924</b>							
924, 924 Turbo	75 » 06.86	444730G	444730 <sup>(1)</sup>	FU	114741G	114741	SC



MODELE MODEL	ANNEE / YEAR						
		AVANT / FRONT			ARRIÈRE / REAR		
		GAZ / GAS	HYD	TYPE	GAZ / GAS	HYD	TYPE
<b>924</b>							
Carrera GT, 937	80 » 06.86	444730G	444730 <sup>(1)</sup>	FU	114741G	114741	SC
<b>930</b>							
	79 » 02.87				254106G	254106	GC
<b>944</b>							
Except Turbo	80 » 07.84	444730G	444730	FU	114741G	114741	SC
Except Turbo	08.84 » 06.86	444730G	444730	FU	214057G	214057	GC

## RELIANT

### ROBIN

	73 » 90		114914	SC		114914	SC
--	---------	--	--------	----	--	--------	----

## RENAULT

### 4 CV

D'origine télescopique/Original telescopic  Except AutoBleu	51 » 62	141122G	141122	SC	151123G	151123	SC
---	---------	---------	--------	----	---------	--------	----

### RENAULT B Series

#### B70 & B80

(FN40/60) 	83 »	245581G	245581	GC	255582G	255582	GC
---	------	---------	--------	----	---------	--------	----

#### B90 & B110 & B120

(FN40/60) 	86 »	145583G	145583	SC	155584G	155584	SC
---	------	---------	--------	----	---------	--------	----



### RENAULT CAPTUR

#### CAPTUR













	13 »	545910G	545910	JF	255921G	255921	GC
--	------	---------	--------	----	---------	--------	----

### RENAULT CLIO I













#### CLIO I Except Automatic

357F, 357L, 357R  Except <b>A</b>	90 » 01.98	545195G <sup>(1)</sup>	545195 <sup>(1)</sup>	JF	214055G	214055	GC
357G, 357J, 357K, 357Y  Except ABS, <b>A</b>	90 » 01.98	545195G <sup>(1)</sup>	545195 <sup>(1)</sup>	JF	214055G	214055	GC
557F, 557L, 557R  Except <b>A</b>	90 » 01.98	545195G <sup>(1)</sup>	545195 <sup>(1)</sup>	JF	214055G	214055	GC



MODELE MODEL	ANNEE / YEAR						
		AVANT / FRONT			ARRIÈRE / REAR		
		GAZ / GAS	HYD	TYPE	GAZ / GAS	HYD	TYPE
<b>CLIO I Except Automatic</b>							
557G, 557J, 557K, 557Y  Except ABS, <b>A</b>	90 » 01.98	(1) 545195G	(1) 545195	JF	214055G	214055	GC
657K  Except <b>A</b>	90 » 01.98	(1) 545195G	(1) 545195	JF	214055G	214055	GC
357D  Except <b>A</b>	90 » 01.98	(2) 545196G	(2) 545196	JF	214055G	214055	GC
357G, 357J (+) ABS Except <b>A</b>	90 » 01.98	(2) 545196G	(2) 545196	JF	214055G	214055	GC
357K, 357Y  (+) ABS Except <b>A</b>	90 » 04.97	(2) 545196G	(2) 545196	JF	214055G	214055	GC
357N, 357U  Except <b>A</b>	90 » 04.97	(2) 545196G	(2) 545196	JF	214055G	214055	GC
557A, 557B  Except <b>A</b>	90 » 04.97	(2) 545196G	(2) 545196	JF	214055G	214055	GC
557D  Except <b>A</b>	90 » 01.98	(2) 545196G	(2) 545196	JF	214055G	214055	GC
557G, 557J  (+) ABS Except <b>A</b>	90 » 01.98	(2) 545196G	(2) 545196	JF	214055G	214055	GC
557K, 557Y  (+) ABS Except <b>A</b>	90 » 04.97	(2) 545196G	(2) 545196	JF	214055G	214055	GC
557N, 557U  Except <b>A</b>	90 » 04.97	(2) 545196G	(2) 545196	JF	214055G	214055	GC
657H, 657M, 657N  Except <b>A</b>	90 » 04.97	(2) 545196G	(2) 545196	JF	214055G	214055	GC







MODELE MODEL	ANNEE / YEAR						
		AVANT / FRONT			ARRIÈRE / REAR		
		GAZ / GAS	HYD	TYPE	GAZ / GAS	HYD	TYPE
<b>CLIO I Except Automatic</b>							
357A, 357N, 357U  Except <b>A</b>	05.97 » 01.98	<sup>(3)</sup> 545365G	<sup>(3)</sup> 545365	JF	214055G	214055	GC
357K, 357Y (+) ABS Except <b>A</b>	05.97 » 01.98	<sup>(3)</sup> 545365G	<sup>(3)</sup> 545365	JF	214055G	214055	GC
557A, 557B  Except <b>A</b>	05.97 » 01.98	<sup>(3)</sup> 545365G	<sup>(3)</sup> 545365	JF	214055G	214055	GC
557K, 557Y (+) ABS Except <b>A</b>	05.97 » 01.98	<sup>(3)</sup> 545365G	<sup>(3)</sup> 545365	JF	214055G	214055	GC
557N, 557U  Except <b>A</b>	05.97 » 01.98	<sup>(3)</sup> 545365G	<sup>(3)</sup> 545365	JF	214055G	214055	GC
657H, 657M, 657N  Except <b>A</b>	05.97 » 01.98	<sup>(3)</sup> 545365G	<sup>(3)</sup> 545365	JF	214055G	214055	GC
B571, C571, S571  Except <b>A</b>	90 » 01.98	<sup>(1)</sup> 545195G	<sup>(1)</sup> 545195	JF	114054G	114054	SC
B572, C572, S572  Except <b>A</b>	90 » 01.98	<sup>(1)</sup> 545195G	<sup>(1)</sup> 545195	JF	114054G	114054	SC
B577, C577, S577  Except <b>A</b>	90 » 01.98	<sup>(1)</sup> 545195G	<sup>(1)</sup> 545195	JF	114054G	114054	SC
B573, C573  Except S Except <b>A</b>	90 »	<sup>(2)</sup> 545196G	<sup>(2)</sup> 545196	JF	114054G	114054	SC
B573, C57  Except S, <b>A</b>	10.92 » 01.98	<sup>(1)</sup> 545195G	<sup>(1)</sup> 545195	JF	114054G	114054	SC
B573, C573 S,  Except <b>A</b>	90 » 01.98	<sup>(2)</sup> 545196G	<sup>(2)</sup> 545196	JF	114054G	114054	SC

















MODELE MODEL	ANNEE / YEAR						
		AVANT / FRONT			ARRIÈRE / REAR		
		GAZ / GAS	HYD	TYPE	GAZ / GAS	HYD	TYPE
<b>CLIO I Except Automatic</b>							
B574, C574  Except <b>A</b>	90 » 01.98	<sup>(2)</sup> 545196G	<sup>(2)</sup> 545196	JF	214055G	214055	GC
B576, C576, S576  Except <b>A</b>	90 » 01.98	<sup>(2)</sup> 545196G	<sup>(2)</sup> 545196	JF	214055G	214055	GC
B578, C578 Tous/All Model Except <b>A</b>	90 » 04.97	<sup>(2)</sup> 545196G	<sup>(2)</sup> 545196	JF	214055G	214055	GC
B578, C578  Except <b>A</b>	05.97 » 01.98	<sup>(3)</sup> 545365G	<sup>(3)</sup> 545365	JF	214055G	214055	GC
C575 1.8 16V	91 » 01.98	545197G	545197	JF	215101G	215101	GC
B57A, C57A, S57A  Except <b>A</b>	90 »	<sup>(2)</sup> 545196G	<sup>(2)</sup> 545196	JF	214055G	214055	GC
B57B, C57B  Except S, RTi, <b>A</b>	90 »	<sup>(2)</sup> 545196G	<sup>(2)</sup> 545196	JF	214055G	214055	GC
B57R, C57R, S57R  Except <b>A</b>	90 »	<sup>(2)</sup> 545196G	<sup>(2)</sup> 545196	JF	214055G	214055	GC
B57T, C57T  Except S, RTi, <b>A</b>	90 »	<sup>(2)</sup> 545196G	<sup>(2)</sup> 545196	JF	214055G	214055	GC
B57A, C57A, S57A  Except <b>A</b>	10.92 »	<sup>(1)</sup> 545195G	<sup>(1)</sup> 545195	JF	114054G	114054	SC
B57B, C57B  Except S, RTi, <b>A</b>	10.92 »	<sup>(1)</sup> 545195G	<sup>(1)</sup> 545195	JF	114054G	114054	SC
B57R, C57R, S57R  Except <b>A</b>	10.92 »	<sup>(1)</sup> 545195G	<sup>(1)</sup> 545195	JF	214055G	214055	GC
B57T, C57T  Except S, RTi, <b>A</b>	10.92 »	<sup>(1)</sup> 545195G	<sup>(1)</sup> 545195	JF	214055G	214055	GC



MODELE MODEL	ANNEE / YEAR						
		AVANT / FRONT			ARRIÈRE / REAR		
		GAZ / GAS	HYD	TYPE	GAZ / GAS	HYD	TYPE
<b>CLIO I Except Automatic</b>							
B57B, C57B S, RTi  Except <b>A</b>	90 » 12.93	<sup>(2)</sup> 545196G	<sup>(2)</sup> 545196	JF	114054G	114054	SC
B57C, C57C  Except <b>A</b>	90 » 12.93	<sup>(2)</sup> 545196G	<sup>(2)</sup> 545196	JF	214055G	214055	GC
B57i, C57i, S57i  Except <b>A</b>	90 » 12.93	<sup>(2)</sup> 545196G	<sup>(2)</sup> 545196	JF	214055G	214055	GC
B57L, C57L, S57L  Except <b>A</b>	90 » 12.93	<sup>(2)</sup> 545196G	<sup>(2)</sup> 545196	JF	214055G	214055	GC
B57T, C57T S, RTi  Except <b>A</b>	90 » 12.93	<sup>(2)</sup> 545196G	<sup>(2)</sup> 545196	JF	114054G	114054	SC
B57U, C57U  Except <b>A</b>	90 » 12.93	<sup>(2)</sup> 545196G	<sup>(2)</sup> 545196	JF	214055G	214055	GC
B57A  Except ABS, <b>A</b>	01.94 » 01.98	<sup>(1)</sup> 545195G	<sup>(1)</sup> 545195	JF	114054G	114054	SC
B57B  Except S, <b>A</b>	01.94 » 04.96	<sup>(1)</sup> 545195G	<sup>(1)</sup> 545195	JF	114054G	114054	SC
B57J Except ABS, <b>A</b>	01.94 » 04.97	<sup>(1)</sup> 545195G	<sup>(1)</sup> 545195	JF	114054G	114054	SC
B57R, B57T  Except <b>A</b>	01.94 » 01.98	<sup>(1)</sup> 545195G	<sup>(1)</sup> 545195	JF	214055G	214055	GC
B57S  Except ABS, <b>A</b>	01.94 » 01.98	<sup>(1)</sup> 545195G	<sup>(1)</sup> 545195	JF	214055G	214055	GC
B57Y  Except ABS, <b>A</b>	01.94 » 04.96	<sup>(1)</sup> 545195G	<sup>(1)</sup> 545195	JF	214055G	214055	GC
C57A  Except <b>A</b>	01.94 » 04.97	<sup>(1)</sup> 545195G	<sup>(1)</sup> 545195	JF	114054G	114054	SC















MODELE MODEL	ANNEE / YEAR						
		AVANT / FRONT			ARRIÈRE / REAR		
		GAZ / GAS	HYD	TYPE	GAZ / GAS	HYD	TYPE
<b>CLIO I Except Automatic</b>							
C57B  Except RTi, S, <b>A</b>	01.94 » 04.96	<sup>(1)</sup> 545195G	<sup>(1)</sup> 545195	JF	114054G	114054	SC
C57R  Except <b>A</b>	01.94 » 01.98	<sup>(1)</sup> 545195G	<sup>(1)</sup> 545195	JF	214055G	214055	GC
C57S  Except ABS, <b>A</b>	01.94 » 01.98	<sup>(1)</sup> 545195G	<sup>(1)</sup> 545195	JF	214055G	214055	GC
C57T  Except RTi, S Except <b>A</b>	01.94 » 01.98	<sup>(1)</sup> 545195G	<sup>(1)</sup> 545195	JF	214055G	214055	GC
C57Y  Except ABS, RTi, <b>A</b>	01.94 » 04.96	<sup>(1)</sup> 545195G	<sup>(1)</sup> 545195	JF	214055G	214055	GC
S57A, S57R  Except <b>A</b>	01.94 » 01.98	<sup>(1)</sup> 545195G	<sup>(1)</sup> 545195	JF	214055G	214055	GC
B57A  (+) ABS Except <b>A</b>	01.94 » 04.97	<sup>(2)</sup> 545196G	<sup>(2)</sup> 545196	JF	114054G	114054	SC
B57B  S Except <b>A</b>	01.94 » 04.96	<sup>(2)</sup> 545196G	<sup>(2)</sup> 545196	JF	114054G	114054	SC
B57B  Except <b>A</b>	05.96 » 04.97	<sup>(2)</sup> 545196G	<sup>(2)</sup> 545196	JF	114054G	114054	SC
B57C, B57i  Except <b>A</b>	01.94 » 04.97	<sup>(2)</sup> 545196G	<sup>(2)</sup> 545196	JF	214055G	214055	GC
B57J  (+) ABS Except <b>A</b>	01.94 » 04.97	<sup>(2)</sup> 545196G	<sup>(2)</sup> 545196	JF	214055G	214055	GC
B57L  Except <b>A</b>	01.94 » 04.97	<sup>(2)</sup> 545196G	<sup>(2)</sup> 545196	JF	214055G	214055	GC















MODELE MODEL	ANNEE / YEAR						
		AVANT / FRONT			ARRIÈRE / REAR		
		GAZ / GAS	HYD	TYPE	GAZ / GAS	HYD	TYPE
<b>CLIO I Except Automatic</b>							
B57S  (+) with ABS Except <b>A</b>	01.94 » 01.98	(2) 545196G	(2) 545196	JF	214055G	214055	GC
B57U  Except <b>A</b>	01.94 » 01.98	(2) 545196G	(2) 545196	JF	214055G	214055	GC
B57Y (+) ABS Except <b>A</b>	01.94 »	(2) 545196G	(2) 545196	JF	214055G	214055	GC
B57Y  Except <b>A</b>	05.96 » 04.97	(2) 545196G	(2) 545196	JF	214055G	214055	GC
C57B RTi, S  Except <b>A</b>	01.94 » 04.96	(2) 545196G	(2) 545196	JF	114054G	114054	SC
C57B  Except <b>A</b>	05.96 » 04.97	(2) 545196G	(2) 545196	JF	114054G	114054	SC
C57C, C57i, C57J, C57L  Except <b>A</b>	01.94 » 04.97	(2) 545196G	(2) 545196	JF	214055G	214055	GC
C57S  (+) ABS Except <b>A</b>	01.94 » 03.98	(2) 545196G	(2) 545196	JF	214055G	214055	GC
C57T RTi, S  Except <b>A</b>	01.94 » 01.98	(2) 545196G	(2) 545196	JF	214055G	214055	GC
C57U  Except <b>A</b>	01.94 » 01.98	(2) 545196G	(2) 545196	JF	214055G	214055	GC
C57Y  (+) ABS, RTi Except <b>A</b>	01.94 » 04.96	(2) 545196G	(2) 545196	JF	214055G	214055	GC
C57Y  Except <b>A</b>	05.96 » 04.97	(2) 545196G	(2) 545196	JF	214055G	214055	GC























MODELE MODEL	ANNEE / YEAR						
		AVANT / FRONT			ARRIÈRE / REAR		
		GAZ / GAS	HYD	TYPE	GAZ / GAS	HYD	TYPE
<b>CLIO I Except Automatic</b>							
S57i, S57L  Except <b>A</b>	01.94 » 04.97	<sup>(2)</sup> 545196G	<sup>(2)</sup> 545196	JF	214055G	214055	GC
B57A  (+) ABS Except <b>A</b>	05.97 » 01.98	<sup>(3)</sup> 545365G	<sup>(3)</sup> 545365	JF	114054G	114054	SC
B57B, C57A, C57B  Except <b>A</b>	05.97 » 01.98	<sup>(3)</sup> 545365G	<sup>(3)</sup> 545365	JF	214055G	214055	GC
B57J, C57J  Except <b>A</b>	05.97 » 01.98	<sup>(3)</sup> 545365G	<sup>(3)</sup> 545365	JF	214055G	214055	GC
B57Y, C57Y  Except <b>A</b>	05.97 » 01.98	<sup>(3)</sup> 545365G	<sup>(3)</sup> 545365	JF	214055G	214055	GC
B57C, C57C  Except <b>A</b>	05.97 » 01.98	<sup>(3)</sup> 545365G	<sup>(3)</sup> 545365	JF	214055G	214055	GC
B57i, C57i, S57i  Except <b>A</b>	05.97 » 01.98	<sup>(3)</sup> 545365G	<sup>(3)</sup> 545365	JF	214055G	214055	GC
B57L, C57L, S57L  Except <b>A</b>	05.97 » 01.98	<sup>(3)</sup> 545365G	<sup>(3)</sup> 545365	JF	214055G	214055	GC
B57N, B57P  Except <b>A</b>	05.97 » 01.98	<sup>(3)</sup> 545365G	<sup>(3)</sup> 545365	JF	214055G	214055	GC
<b>CLIO I</b>							
C57D 1.8 16V	91 » 01.98	545197G	545197	JF	215101G	215101	GC
C57M 2.0 Williams 16V	93 » 01.98	545267G	545267	JF	215271G	215271	GC
<b>CLIO I AUTOMATIC</b>							
	90 » 05.97	545196G <sup>(2)</sup>	545196 <sup>(2)</sup>	JF	214055G	214055	GC
	06.97 » 01.98	545365G <sup>(3)</sup>	545365 <sup>(3)</sup>	JF	214055G	214055	GC























MODELE MODEL	ANNEE / YEAR						
		AVANT / FRONT			ARRIÈRE / REAR		
		GAZ / GAS	HYD	TYPE	GAZ / GAS	HYD	TYPE
<b>RENAULT CLIO II (B)</b>							
<b>CLIO II</b>							
(BB, CB, SB)  1.1, 1.2, 1.2 16V	02.98 » 08.05	<sup>(4)</sup> 545366G	<sup>(4)</sup> 545366	JF	155363G	155363	SC
(BB, CB, SB)  1.2 16V, 1.4 16V (Si Inclus) 1.5 dCi, 1.5 dTi	02.98 » 08.05	<sup>(4)</sup> 545367G	<sup>(4)</sup> 545367	JF	155450G	155450	SC
(BB, CB, SB)  1.6, 1.6 16V (Si Inclus) 1.9 D, 1.9 dTi (Si Inclus)	02.98 » 08.05	<sup>(4)</sup> 545367G	<sup>(4)</sup> 545367	JF	155450G	155450	SC
 CAMPUS 1.2 (16V inclus)	03 »	<sup>(4)</sup> 545366G	<sup>(4)</sup> 545366	JF	155363G	155363	SC
 CAMPUS 1.5 dCi, 1.6 (16V inclus)	03 »	<sup>(4)</sup> 545367G	<sup>(4)</sup> 545367	JF	155450G	155450	SC
<b>RENAULT CLIO II</b>							
<b>CLIO II</b>							
CLASSIC, SYMBOL 1, THALIA  Sedan 1.2, 1.4 8V	98 » 08.08	545557G	545557	JF	155450G	155450	SC
CLASSIC, SYMBOL 1, THALIA  Sedan 1.4 16V	98 » 08.08	545367G	545367	JF	155450G	155450	SC
CLASSIC, SYMBOL 1, THALIA  Sedan 1.5 dCi, 1.6 16V, 1.9 D/dCi	98 » 08.08	<sup>(5)</sup> 545366G 545367G	<sup>(5)</sup> 545366 545367	JF	155450G	155450	SC
SYMBOL 2, THALIA 2  Sedan 1.2, 1.4	09.08 » 07.14	<sup>(5)</sup> 545366G	<sup>(5)</sup> 545366	JF	155450G	155450	SC
SYMBOL 2, THALIA 2  Sedan 1.5 dCi, 1.6	09.08 » 07.14	<sup>(5)</sup> 545366G 545367G	<sup>(5)</sup> 545366 545367	JF	155450G	155450	SC



























MODELE MODEL	ANNEE / YEAR						
		AVANT / FRONT			ARRIÈRE / REAR		
		GAZ / GAS	HYD	TYPE	GAZ / GAS	HYD	TYPE
<b>RENAULT CLIO III (R)</b>							
<b>CLIO III</b>							
(BR, CR) Phases 1, 2  Except RS	09.05 » 10.12	545674G	545674	JF	255675G	255675	GC
 Grandtour	08 » 02.13	545674G	545674	JF	255675G	255675	GC
CLASSIC, SYMBOL 3, THALIA 3  Sedan (-)  (-) 	08.14 »	545892G	545892	JF	155893G	155893	SC
CLASSIC, SYMBOL 3, THALIA 3  Sedan (-)  (+) 	08.14 »	545878G	545878	JF	155893G	155893	SC
CLASSIC, SYMBOL 3, THALIA 3  Sedan (+)  (-) Suspension Surlevée	08.14 »	545891G	545891	JF	155893G	155893	SC
CLASSIC, SYMBOL 3, THALIA 3  Sedan (+)  (+) 	08.14 »	545908G	545908	JF	155893G	155893	SC
<b>CLIO III COLLECTION</b>							
	11.12 »	545674G	545674	JF	255675G	255675	GC
<b>RENAULT CLIO IV</b>							
<b>CLIO IV</b>							
 Except RS	11.12 »	545876G	545876	JF	255877G	255877	GC
 -  Except GT	03.13 »	545876G	545876	JF	255877G	255877	GC
<b>RENAULT DAUPHINE</b>							
<b>DAUPHINE &amp; ONDINE</b>							
Gordini inclus (Suspension non aerostable)	56 » 09.60	141112G	141112	SC	151121G	151121	SC

















MODELE MODEL	ANNEE / YEAR						
		AVANT / FRONT			ARRIÈRE / REAR		
		GAZ / GAS	HYD	TYPE	GAZ / GAS	HYD	TYPE
<b>DAUPHINE &amp; ONDINE</b>							
Gordini inclus (Suspension aerostable)	56 » 09.60	141116G	141116	SC	151121G	151121	SC
Gordini inclus (Suspension aerostable)	10.60 » 05.64	141116G	141116	SC	151110G	151110	SC
Gordini inclus (Suspension aerostable)	06.64 » 12.66	141116G	141116	SC	151121G	151121	SC
<b>DAUPHINE</b>							
Gordini inclus	01.67 »	141116G	141116	SC	151743 <sup>(6)</sup>	151743 <sup>(6)</sup>	SC
<b>RENAULT ESPACE 1 (J11, S11)</b>							
<b>ESPACE I</b>							
J112 Except   → T005812	05.84 » 11.84				114038G	114038	SC
J112 Except   T005813  → T036434	12.84 » 12.87	364037G	364037	SR	114038G	114038	SC
J115 (Diesel)  → T002896 Except 	12.84 » 12.87	364037G	364037	SR	114038G	114038	SC
J117  → T003258 Except 	12.84 » 12.87	364037G	364037	SR	114038G	114038	SC
S112  → T000620 Except 	12.84 » 12.87	364037G	364037	SR	114038G	114038	SC
S115 (Diesel)  → T000841 Except 	12.84 » 12.87	364037G	364037	SR	114038G	114038	SC
J112  T036435 → Except 	01.88 » 03.91	365116G	365116	SR	114038G	114038	SC
J112  K000001 → Except 	01.88 » 03.91	365116G	365116	SR	114038G	114038	SC
J115 (Diesel)  T002897 → Except 	01.88 » 03.91	365116G	365116	SR	114038G	114038	SC























MODELE MODEL	ANNEE / YEAR						
		AVANT / FRONT			ARRIÈRE / REAR		
		GAZ / GAS	HYD	TYPE	GAZ / GAS	HYD	TYPE
<b>ESPACE I</b>							
J116  T000001 → Except 	01.88 » 03.91	365116G	365116	SR	114038G	114038	SC
J116  K000001 → Except 	01.88 » 03.91	365116G	365116	SR	114038G	114038	SC
J117  T003259 → Except 	01.88 » 03.91	365116G	365116	SR	114038G	114038	SC
S112  T000621 → Except 	01.88 » 03.91	365116G	365116	SR	114038G	114038	SC
S115 (Diesel)  T000842 → Except 	01.88 » 03.91	365116G	365116	SR	114038G	114038	SC
<b>RENAULT ESPACE II</b>							
<b>ESPACE II</b>							
J633, J634, J635 Except 	04.91 » 09.96	365154G	365154	SR	114038G	114038	SC
J636, J637, J638 Except 	04.91 » 09.96	365154G	365154	SR	114038G	114038	SC
J63D, J63E, J63G Except 	04.91 » 09.96	365154G	365154	SR	114038G	114038	SC
S635, S637, S63D Except 	04.91 » 09.96	365154G	365154	SR	114038G	114038	SC
	04.91 » 09.96	365154G	365154	SR			
<b>RENAULT ESPACE III ( JE ), GRAND ESPACE III</b>							
<b>ESPACE III</b>							
 /WB = 2.70m (+) 	10.96 » 08.02	545287G	545287	JF	215288G	215288	GC
 /WB = 2.70m (-)  JEOA, JEOL, JEOM, JEON	10.96 » 08.02	545287G	545287	JF	215288G	215288	GC
 /WB = 2.70m (-)  JEOD, JROE, JEOG, JEOH, JEOP, JEOS	10.96 » 08.02	545287G	545287	JF	215352G	215352	GC
<b>GRAND ESPACE III</b>							
 /WB = 2.87m	10.96 » 08.02	545287G	545287	JF	215352G	215352	GC

















MODELE MODEL	ANNEE / YEAR						
		AVANT / FRONT			ARRIÈRE / REAR		
		GAZ / GAS	HYD	TYPE	GAZ / GAS	HYD	TYPE
<b>RENAULT ESPACE IV (JK)</b>							
<b>ESPACE IV</b>							
 Except 	09.02 » 03.15				215722G <sup>(7)</sup>	215722 <sup>(7)</sup>	GC
<b>GRAND ESPACE IV</b>							
 Except 	09.02 » 03.15				215722G <sup>(7)</sup>	215722 <sup>(7)</sup>	GC
<b>RENAULT ESTAFETTE</b>							
<b>ESTAFETTE</b>							
	59 »		261168	GC	171119G	171119	SC
<b>RENAULT FLUENCE</b>							
<b>FLUENCE</b>							
 Except Z.E	09 »	545855G	545855	JF	215856G	215856	GC
<b>RENAULT FLORIDE</b>							
<b>FLORIDE</b>							
Gordini inclus (Suspension non aerostable)	56 » 59	141112G	141112	SC	151121G	151121	SC
Gordini inclus (Suspension aerostable)	56 » 09.60	141116G	141116	SC	151121G	151121	SC
Gordini inclus (Suspension aerostable)	10.60 » 05.64	141116G	141116	SC	151110G	151110	SC
Gordini inclus (Suspension aerostable)	06.64 » 12.66	141116G	141116	SC	151121G	151121	SC
<b>FLORIDE &amp; CARAVELLE</b>							
 	56 » 05.64	141114G	141114	SC	151115G	151115	SC
 	06.64 »	141114G	141114	SC	151121G	151121	SC
<b>RENAULT FREGATE</b>							
<b>FREGATE</b>							
 AMIRAL, DOMAINE, GRAND PAVOIS, MANOIR	55 » 60		101125	SC		171120	SC
<b>RENAULT FUEGO</b>							
<b>FUEGO</b>							
	80 » 87	364795G	364795	SR	174502G	174502	SC
<b>RENAULT GOELETTE</b>							
<b>GOELETTE</b>							
R 2086, R 4086, R 4088	05.59 »		261621	GC		231622	GC















MODELE MODEL	ANNEE / YEAR						
		AVANT / FRONT			ARRIÈRE / REAR		
		GAZ / GAS	HYD	TYPE	GAZ / GAS	HYD	TYPE
<b>RENAULT JEEP (4X4 )</b>							
<b>CHEROKEE &amp; WAGONEER</b>							
(XJ)	84 » 90	244019G		GC	214010G		GC
<b>GRAND CHEROKEE &amp; GRAND WAGONEER</b>							
	84 » 91	104770G		SC	114781G		SC
Except Special Suspension	92 » 98	244019G		GC			
(XJ) JB, JN	91 » 98				214010G		GC
<b>GRAND CHEROKEE</b>							
(ZJ) ZB, ZN	94 » 98		744017	PLL		714018	PLL
<b>LAREDO , RENEGADE</b>							
CJ5, CJ6, CJ7	82 » 86	204891G	204891	GC	214880G	214880	GC
<b>RENAULT KADJAR</b>							
<b>KADJAR</b>							
  	15 »				215037G	215037	GC
<b>RENAULT KANGOO</b>							
<b>KANGOO I</b>							
(FC, KC)    Except  , Pampa, Decathlon Except 	<sup>(8)</sup> 97 » 09.07	545438G	545438	JF	115439G	115439	SC
(FC, KC)     Except Pampa, Decathlon Except 	<sup>(8)</sup> 97 » 12.07	545438G	545438	JF	215430G	215430	GC
(FC, KC)  Pampa Except 	98 »	545588G	545588	JF	215589G	215589	GC
(FC, KC)  1.6 16V, 1.9 dCi	01 »				215690G	215690	GC
<b>KANGOO II</b>							
(FW)   Long  /WB = 2.70m Except Extrem, ZE	01.08 »	545762G 545846G	545762 545846	JF	215763G	215763	GC









MODELE MODEL	ANNEE / YEAR						
		AVANT / FRONT			ARRIÈRE / REAR		
		GAZ / GAS	HYD	TYPE	GAZ / GAS	HYD	TYPE
<b>KANGOO II BE POP</b>							
(FW)  Court/Short  /WB = 2.31m Except ZE	02.09 »	545762G 545846G	545762 545846	JF	215763G	215763	GC
<b>KANGOO II EXPRESS</b>							
(FW) 	10.07 »	545762G 545846G	545762 545846	JF	215763G	215763	GC
<b>GRAND KANGOO II</b>							
(FW)  Long  /WB = 3.08m Except ZE	04.12 »	545762G 545846G	545762 545846	JF	215763G	215763	GC
<b>RENAULT KOLEOS</b>							
<b>KOLEOS</b>							
	08 »	545825G L 545826G R	545825 L 545826 R	JF	215827G	215827	GC
<b>RENAULT LAGUNA 1 Berline/Saloon</b>							
<b>LAGUNA</b>							
 Liftback B56A, B56B, B56C, B56H, B56S, B56Z  (V6 inclus)	93 » 04.95	<sup>(10) (11)</sup> 545199G	<sup>(10) (11)</sup> 545199	JF	215188G	215188	GC
 Liftback B56A, B56B, B56S, B56Z (-) Original Air Cond	05.95 » 12.00	<sup>(10)</sup> 545190G	<sup>(10)</sup> 545190	JF	215188G	215188	GC
 Liftback B56A, B56B, B56S, B56Z (+) Original Air Cond	05.95 » 12.00	<sup>(10) (11)</sup> 545199G	<sup>(10) (11)</sup> 545199	JF	215188G	215188	GC
 B56C, B56H (-) ABS	05.95 » 12.00	<sup>(10)</sup>	<sup>(10)</sup>	JF	215188G	215188	GC
 B56C, B56H (+) ABS	05.95 » 12.00	<sup>(10)</sup> 545199G	<sup>(10)</sup> 545199	JF	215188G	215188	GC
 B562, B566, B569, B56D, B56E, B56F, B56M, B56P, B56R, B56V, B56W	93 » 12.00	<sup>(10)</sup> 545199G	<sup>(10)</sup> 545199	JF	215188G	215188	GC





MODELE MODEL	ANNEE / YEAR						
		AVANT / FRONT			ARRIÈRE / REAR		
		GAZ / GAS	HYD	TYPE	GAZ / GAS	HYD	TYPE
<b>LAGUNA</b>							
 B56L <b>M</b> (-) ABS	93 » 12.00	<sup>(10)</sup> 545190G	<sup>(10)</sup> 545190	JF	215188G	215188	GC
 B56L <b>M</b> (+) ABS	93 » 12.00	<sup>(10) (11)</sup> 545199G	<sup>(10) (11)</sup> 545199	JF	215188G	215188	GC
 B56L Boîte <b>A</b>	93 » 12.00	<sup>(10) (11)</sup> 545199G	<sup>(10) (11)</sup> 545199	JF	215188G	215188	GC
 B560, B563, B564, B56T (-) Original Air Cond	93 » 12.00	<sup>(10)</sup> 545190G	<sup>(10)</sup> 545190	JF	215188G	215188	GC
 B560, B563, B564, B56T (+) Original Air Cond	93 » 12.00	<sup>(10) (11)</sup> 545199G	<sup>(10) (11)</sup> 545199	JF	215188G	215188	GC
 B568, B56G, B56J, B56N, B56U	93 » 12.00	<sup>(10) (11)</sup> 545199G 545190G	<sup>(10) (11)</sup> 545199 545190	JF	215188G	215188	GC
<b>RENAULT LAGUNA 1 Break/Estate</b>							
<b>LAGUNA I NEVADA</b>							
(K56) 	95 » 12.00	<sup>(11)</sup> 545199G	<sup>(11)</sup> 545199	JF	215234G	215234	GC
<b>RENAULT LAGUNA 2 Berline/Saloon</b>							
<b>LAGUNA II</b>							
(BG, B74)  Except 1.9 dCi	01.01 » 09.07	<sup>(12)</sup> 545578G	<sup>(12)</sup> 545578	JF	215637G	215637	GC
(BG, B74)  1.9 dCi	01.01 » 09.07	<sup>(12)</sup> 545578G	<sup>(12)</sup> 545578	JF	115631G	115631	SC
<b>RENAULT LAGUNA 2 Break/Estate</b>							
<b>LAGUNA II ESTATE</b>							
(KG, K74)  Grandtour	01.01 » 10.07	<sup>(12)</sup> 545578G	<sup>(12)</sup> 545578	JF	215638G	215638	GC





























MODELE MODEL	ANNEE / YEAR						
		AVANT / FRONT			ARRIÈRE / REAR		
		GAZ / GAS	HYD	TYPE	GAZ / GAS	HYD	TYPE
<b>RENAULT LAGUNA 3</b>							
<b>LAGUNA III</b>							
(BT)  Except GT, (SS) 	10.07 »	545750G	545750	JF	215761G	215761	GC
(KT)  Except GT, (SS) 	12.07 »	545750G	545750	JF	215761G	215761	GC
<b>RENAULT MASTER (4x2)</b>							
<b>MASTER I</b>							
(FC30)  PROPULSION/RWD (Serie Q) P28, P30, P35	80 » 08.97	344849G	344849	SR	115182G	115182	SC
(FB30)  TRACTION/FWD (Serie R) T28, T30, T35 RC7, RL7	80 » 02.89	344849G	344849	SR	174848G	174848	SC
(FB30)  TRACTION/FWD (Serie R) T28, T30, T35 RC7, RH9, RJ9, RL7	80 » 02.89	344849G	344849	SR	174848G	174848	SC
(FB30)  TRACTION/FWD (Serie R) RC9, RD9, RL9	80 » 02.89	344849G	344849	SR	115182G	115182	SC
(FB30)  TRACTION/FWD (Serie R)	80 » 02.89	344849G	344849	SR	175354G	175354	SC
(FB30)  TRACTION/FWD (Serie R) T28, T30, T35 RC7, RL7	03.89 » 08.97	344094G	344094	SR	174848G	174848	SC



















MODELE MODEL	ANNEE / YEAR						
		AVANT / FRONT			ARRIÈRE / REAR		
		GAZ / GAS	HYD	TYPE	GAZ / GAS	HYD	TYPE
<b>MASTER I</b>							
(FB30)  TRACTION/FWD (Serie R) T28, T30, T35 RC7, RH9, RJ9, RL7	03.89 » 08.97	344094G	344094	SR	174848G	174848	SC
(FB30)  TRACTION/FWD (Serie R) RC9, RD9, RL9	03.89 » 08.97	344094G	344094	SR	115182G	115182	SC
(FB30)  TRACTION/FWD (Serie R)	03.89 » 08.97	344094G	344094	SR	175354G	175354	SC
<b>MASTER II</b>							
 (Serie L) ED, FD, JD Except 	09.97 » 03.10	205461G	205461	GC	215465G	215465	GC
 (Serie L) ED, FD, JD (+) 	09.97 » 03.10	205461G	205461	GC			
 (Serie L) HD, UD Except 	09.97 » 03.10	205461G	205461	GC	215466G	215466	GC
 (Serie L) HD, UD 	09.97 » 03.10	205461G	205461	GC			
 (Serie L) ND Except 	09.97 » 03.10	205585G	205585	GC	215465G	215465	GC
 (Serie L) ND 	09.97 » 03.10	205585G	205585	GC			















MODELE MODEL	ANNEE / YEAR						
		AVANT / FRONT			ARRIÈRE / REAR		
		GAZ / GAS	HYD	TYPE	GAZ / GAS	HYD	TYPE
<b>MASTER III</b>							
   PROPULSION/RWD (!) (+)  AR/Rear Except Pneumatic Suspension	04.10 »		545943	JF	215465G	215045	GC
   PROPULSION/RWD (!) (+)  AR/Rear Except Pneumatic Suspension	04.10 »		545943	JF		215046	GC
   TRACTION/FWD  Except Pneumatic Suspension	04.10 »		545943	JF		215044	GC
<b>RENAULT MASTER B</b>							
<b>MASTER B</b>							
 (B Series) B70, B80	83 »		245581	GC		255582	GC
 (B Series) B90, B110, B120	86 »		145583	SC		155584	SC
<b>RENAULT MEGANE I Berline/Saloon, Except Scenic</b>							
<b>MEGANE I</b>							
(BA, CA)   Except 2.0 16V, Scenic	95 » 08.02	545295G	545295	JF	115290G	115290	SC
(BA, CA)   2.0 16V Except Scenic	95 » 10.98	545331G	545331	JF	115437G	115437	SC
(BA, CA)  2.0 16V	11.98 » 08.02				115437G	115437	SC
<b>MEGANE I CLASSIC</b>							
(LA) <sup>(13)</sup>  	96 » 05.03	545295G	545295	JF	115290G	115290	SC
<b>RENAULT MEGANE I Coupé &amp; Cabriolet</b>							
<b>MEGANE I</b>							
(DA)    Except 2.0 16V	95 » 03.03	545295G	545295	JF	115290G	115290	SC



MODELE MODEL	ANNEE / YEAR						
		AVANT / FRONT			ARRIÈRE / REAR		
		GAZ / GAS	HYD	TYPE	GAZ / GAS	HYD	TYPE
<b>MEGANE I</b>							
(DA)  2.0 16V	95 » 10.98	545331G	545331	JF	115332G	115332	SC
(DA)  2.0 16V	11.98 » 05.03				115332G	115332	SC
(EA)  Except 2.0 16V	96 » 03.03	545295G	545295	JF	115290G	115290	SC
(EA)  2.0 16V	96 » 10.98	545331G	545331	JF	115437G	115437	SC
(EA)  2.0 16V	11.98 » 05.03				115437G	115437	SC
<b>RENAULT MEGANE 1 Break/Estate</b>							
<b>MEGANE I</b>							
(KA)  Grandtour	99 » 06.03	545295G	545295	JF	215527G	215527	GC
<b>RENAULT MEGANE II Berline/Saloon, Except Scenic</b>							
<b>MEGANE II</b>							
(BM, CM)  Except GT, RS, Scenic Except 	09.02 » 10.08	545622G	545622	JF	215623G	215623	GC
(BM, CM)  Except Scenic 	09.02 » 10.08	545713G	545713	JF	215714G	215714	GC
<b>MEGANE II CLASSIC</b>							
(LM)  Except  , Scenic	06.03 » 10.08	545622G	545622	JF	215623G	215623	GC
(LM)  (+) 	06.03 » 10.08	545713G	545713	JF	215714G	215714	GC







MODELE MODEL	ANNEE / YEAR						
		AVANT / FRONT			ARRIÈRE / REAR		
		GAZ / GAS	HYD	TYPE	GAZ / GAS	HYD	TYPE
<b>RENAULT MEGANE II Coupé Cabriolet</b>							
<b>MEGANE II</b>							
(EM)  Except RS	06.03 » 05.10	545622G	545622	JF	215623G	215623	GC
<b>RENAULT MEGANE II Break/Estate</b>							
<b>MEGANE II</b>							
 Grandtour Except 	07.03 » 05.09	545622G	545622	JF	215623G	215623	GC
<b>RENAULT MEGANE III Berline/Saloon, Except Scenic</b>							
<b>MEGANE III</b>							
 Except GT, RS, Scenic	11.08 »	545841G	545841	JF	215623G	215623	GC
<b>RENAULT MEGANE III Coupé Cabriolet</b>							
<b>MEGANE III CC</b>							
 Except GT, RS	06.10 »	545841G	545841	JF			
<b>RENAULT MEGANE III Break/Estate</b>							
<b>MEGANE III</b>							
(KZ)  Grandtour Except GT	06.09 »	545841G	545841	JF	215623	215623	GC
<b>RENAULT MODUS</b>							
<b>MODUS</b>							
(FP, JP)  Except RS	04 »	545674G	545674	JF	255675G	255675	GC
<b>GRAND MODUS</b>							
(FP, JP) 	08 »	545674G	545674	JF	255675G	255675	GC
<b>RENAULT R4</b>							
<b>R4</b>							
 R1120, R1121, R1122  → 954000 Except Rodeo	61 » 09.68	141125G	141125	SC	131126G	131126	SC























MODELE MODEL	ANNEE / YEAR						
		AVANT / FRONT			ARRIÈRE / REAR		
		GAZ / GAS	HYD	TYPE	GAZ / GAS	HYD	TYPE
<b>R4</b>							
 R1123, R1124  → 627131 Except Rodeo	62 » 06.68	141125G	141125	SC	131126G	131126	SC
 R1120  954001 → Except R1128 GTL, Rodeo	10.68 »	141080G	141080	SC	131126G	131126	SC
 R1123  627132 → Except R1128 GTL, Rodeo	07.68 »	141080G	141080	SC	131126G	131126	SC
 R1126  000001 → Except R1128 GTL, Rodeo	71 »	141080G	141080	SC	131126G	131126	SC
 SAFARI Except R1128 GTL, Rodeo	71 »	141080G	141080	SC	131126G	131126	SC
 1128 GTL	78 »	141080G	141080	SC	131678G	131678	SC
RODEO	70 »	141080G	141080	SC	131678G	131678	SC
 R2102, R2105  → 59995	61 » 09.68	141125G	141125	SC	131678G	131678	SC
 R2104, R2106  → 25949	61 » 09.68	141125G	141125	SC	131678G	131678	SC
 R2105  59996 →	10.68 »	141080G	141080	SC	131678G	131678	SC
 R2106  25950 →	10.68 »	141080G	141080	SC	131678G	131678	SC
 R2108, R2109, R2391, R2392  00001 →	70 »	141080G	141080	SC	131678G	131678	SC
 F4, F6, R2340, R2370, R2430	75 »	141080G	141080	SC	131678G	131678	SC



















MODELE MODEL	ANNEE / YEAR						
		AVANT / FRONT			ARRIÈRE / REAR		
		GAZ / GAS	HYD	TYPE	GAZ / GAS	HYD	TYPE
<b>R4</b>							
 SIMPAN	73 »	141125G	141125	SC	131126G	131126	SC
<b>RENAULT R5, Except Super 5</b>							
<b>R5</b>							
 Except LS, TS, TX, Alpine, Rodeo, Turbo	72 » 85	141080G	141080	SC	154777G	154777	SC
LS, TS, TX	72 » 85	141080G	141080	SC	254293G	254293	GC
Rodeo (TEILHOL)	82 » 85	141080G	141080	SC	131678G	131678	SC
ALPINE, ALPINE Turbo	76 » 85	244515G	244515	GC	254516G	254516	GC
<b>RENAULT R5 SUPER 5 / FIVE, Except GT &amp; Express</b>							
<b>SUPER 5</b>							
B400, C400, B401, C401	84 » 05.88	544945G <sup>(14)</sup>	544945 <sup>(14)</sup>	JF	114946G	114946	SC
B403, C403, B407, C407	84 » 05.88	544945G <sup>(14)</sup>	544945 <sup>(14)</sup>	JF	214937G	214937	GC
B40F, C40F, B40H, C40H	84 » 05.88	544945G <sup>(14)</sup>	544945 <sup>(14)</sup>	JF	114946G	114946	SC
B40J, C40J, B40M, C40M	84 » 05.88	544945G <sup>(14)</sup>	544945 <sup>(14)</sup>	JF	214937G	214937	GC
S401, S40F	84 » 05.88	544945G <sup>(14)</sup>	544945 <sup>(14)</sup>	JF	214937G	214937	GC
B402, C402, B404, C404	84 »	544945G <sup>(14)</sup>	544945 <sup>(14)</sup>	JF	214937G	214937	GC
B408, C408	84 »	544945G <sup>(14)</sup>	544945 <sup>(14)</sup>	JF	214937G	214937	GC
B40G, C40G, B40K, C40K	84 »	544945G <sup>(14)</sup>	544945 <sup>(14)</sup>	JF	214937G	214937	GC
S400, S404 (GTX, D, SD, TD, GTD, Five D, Baccara)	84 »	544945G <sup>(14)</sup>	544945 <sup>(14)</sup>	JF	214937G	214937	GC
B400, C400, B401, C401	06.88 »	544048G <sup>(15)</sup>	544048 <sup>(15)</sup>	JF	114946G	114946	SC
B403, C403, B407, C407	06.88 »	544048G <sup>(15)</sup>	544048 <sup>(15)</sup>	JF	214937G	214937	GC
B40F, C40F, B40H, C40H	06.88 »	544048G <sup>(15)</sup>	544048 <sup>(15)</sup>	JF	114946G	114946	SC
B40J, C40J, B40M, C40M	06.88 »	544048G <sup>(15)</sup>	544048 <sup>(15)</sup>	JF	214937G	214937	GC
S401, S407, S40F (SL, TL, TR, GTR, GTS, <b>A</b> , Campus, Five, Saga)	06.88 »	544048G <sup>(15)</sup>	544048 <sup>(15)</sup>	JF	214937G	214937	GC
<b>RENAULT R5 SUPER 5 / FIVE GT</b>							
<b>SUPER 5 GT Turbo</b>							
C405 phase 1	84 » 05.87	544936G	544936	JF	214937G	214937	GC
C405 phase 2	06.87	544974G	544974	JF	214937G	214937	GC
<b>SUPER 5 GTE</b>							
C409	87	544936G	544936	JF	214937G	214937	GC





MODELE MODEL	ANNEE / YEAR						
		AVANT / FRONT			ARRIÈRE / REAR		
		GAZ / GAS	HYD	TYPE	GAZ / GAS	HYD	TYPE
<b>RENAULT R5 SUPER 5 / FIVE EXPRESS Fourgonnette / Van / Pick up</b>							
<b>EXPRESS - EXTRA - RAPID</b>							
(F40) 	85 » 91	<sup>(16) (17)</sup> 544945G	<sup>(16) (17)</sup> 544945	JF	114980G	114980	SC
(F40)  Except 	91 » 10.96	<sup>(16) (17)</sup> 544945G	<sup>(16) (17)</sup> 544945	JF	114980G	114980	SC
(F40) 	91 »	<sup>(16) (17)</sup> 544945G	<sup>(16) (17)</sup> 544945	JF	215232G	215232	GC
(F40)  Except 	11.96 » 10.96	<sup>(17)</sup> 545299G	<sup>(17)</sup> 545299	JF	114980G	114980	SC
	11.96 »	<sup>(17)</sup> 545299G	<sup>(17)</sup> 545299	JF	215232G	215232	GC
<b>RENAULT R6</b>							
<b>R6</b>							
	» 04.68	141125G	141125	SC	131126G	131126	SC
	05.68 » 81	141080G	141080	SC	131126G	131126	SC
Rodeo	73 »	141080G	141080	SC	131678G	131678	SC
<b>RENAULT R8 - R10</b>							
<b>R8 &amp; R10</b>							
R1130  → 338142	62 » 05.64	141114G	141114	SC	151115G	151115	SC
R1131  → 029010	62 » 05.64	141114G	141114	SC	151115G	151115	SC
R1132  → 055726	62 » 05.64	141114G	141114	SC	151115G	151115	SC
R1133  → 012110	62 » 05.64	141114G	141114	SC	151115G	151115	SC
R1130  338143  → 438661	06.64 » 12.66	141114G	141114	SC	151121G	151121	SC
R1131  → 029011	06.64 » 12.66	141114G	141114	SC	151121G	151121	SC
R1132  055727  → 242397	06.64 » 12.66	141114G	141114	SC	151121G	151121	SC
R1190  → 257305	06.64 » 12.66	141114G	141114	SC	151121G	151121	SC
R1130  → 438662	01.67 » 74	141114G	141114	SC	<sup>(6)</sup> 151743G	<sup>(6)</sup> 151743	SC

























MODELE MODEL	ANNEE / YEAR						
		AVANT / FRONT			ARRIÈRE / REAR		
		GAZ / GAS	HYD	TYPE	GAZ / GAS	HYD	TYPE
<b>R8 &amp; R10</b>							
R1132  → 242398	01.67 » 74	141114G	141114	SC	151743G <sup>(6)</sup>	151743 <sup>(6)</sup>	SC
R1136  → 000001	01.67 » 74	141114G	141114	SC	151743G <sup>(6)</sup>	151743 <sup>(6)</sup>	SC
R1190  → 257306	01.67 » 74	141114G	141114	SC	151743G <sup>(6)</sup>	151743 <sup>(6)</sup>	SC
R1192  → 000001	01.67 » 74	141114G	141114	SC	151743G <sup>(6)</sup>	151743 <sup>(6)</sup>	SC
GORDINI, R1134, R1135. 4 Amortisseurs à l'arrière/4 Rear Shocks	10.64 » 74	141118G	141118	SC	151121	151121	SC
<b>RENAULT R9 - R11</b>							
<b>R9 &amp; R11</b>							
L421, L422, L423, L424, L42J, L42S	81 » 91	544884G <sup>(18)</sup>	544884 <sup>(18)</sup>	JF	154874G <sup>(19)</sup>	154874 <sup>(19)</sup>	SC
L426  → D 00003950	81 » 09.86	544884G <sup>(18)</sup>	544884 <sup>(18)</sup>	JF	154874G <sup>(19)</sup>	154874 <sup>(19)</sup>	SC
L426  → H 00005600	81 » 09.86	544884G <sup>(18)</sup>	544884 <sup>(18)</sup>	JF	154874G <sup>(19)</sup>	154874 <sup>(19)</sup>	SC
L42F  → D 00000525	» 09.86	544884G <sup>(18)</sup>	544884 <sup>(18)</sup>	JF	154874G <sup>(19)</sup>	154874 <sup>(19)</sup>	SC
B371, B372, B373, B374, B37J, B37S	81 » 91	544884G <sup>(18)</sup>	544884 <sup>(18)</sup>	JF	154874G <sup>(19)</sup>	154874 <sup>(19)</sup>	SC
B375 (Turbo)  → D 00001343	» 09.86	544884G <sup>(18)</sup>	544884 <sup>(18)</sup>	JF	154874G <sup>(19)</sup>	154874 <sup>(19)</sup>	SC
B376  → D 00043789	» 09.86	544884G <sup>(18)</sup>	544884 <sup>(18)</sup>	JF	154874G <sup>(19)</sup>	154874 <sup>(19)</sup>	SC
B376  → H 00017726	» 84	544884G <sup>(18)</sup>	544884 <sup>(18)</sup>	JF	154874G <sup>(19)</sup>	154874 <sup>(19)</sup>	SC
B37F  → D 00000644	83 » 09.86	544884G <sup>(18)</sup>	544884 <sup>(18)</sup>	JF	154874G <sup>(19)</sup>	154874 <sup>(19)</sup>	SC
C371, C372, C373, C374, C37J, C37S	81 » 91	544884G <sup>(18)</sup>	544884 <sup>(18)</sup>	JF	154874G <sup>(19)</sup>	154874 <sup>(19)</sup>	SC
C375 (Turbo)  → D 00007886	84 » 09.86	544884G <sup>(18)</sup>	544884 <sup>(18)</sup>	JF	154874G <sup>(19)</sup>	154874 <sup>(19)</sup>	SC
C375 (Turbo)  → E 00002300	84 » 09.86	544884G <sup>(18)</sup>	544884 <sup>(18)</sup>	JF	154874G <sup>(19)</sup>	154874 <sup>(19)</sup>	SC
C376  → D 00006418	83 » 09.86	544884G <sup>(18)</sup>	544884 <sup>(18)</sup>	JF	154874G <sup>(19)</sup>	154874 <sup>(19)</sup>	SC
C37F  → D 00000509	83 » 09.86	544884G <sup>(18)</sup>	544884 <sup>(18)</sup>	JF	154874G <sup>(19)</sup>	154874 <sup>(19)</sup>	SC























MODELE MODEL	ANNEE / YEAR						
		AVANT / FRONT			ARRIÈRE / REAR		
		GAZ / GAS	HYD	TYPE	GAZ / GAS	HYD	TYPE
<b>R9 &amp; R11</b>							
S371, S372, S373, S374, S375	81 » 91	544884G <sup>(18)</sup>	544884 <sup>(18)</sup>	JF	154874G <sup>(19)</sup>	154874 <sup>(19)</sup>	SC
L425 (Turbo) Except Zender	84 » 91	544884G <sup>(18)</sup>	544884 <sup>(18)</sup>	JF	154874G <sup>(19)</sup>	154874 <sup>(19)</sup>	SC
L426  D 00003951 →	09.86 » 91	544884G <sup>(18)</sup>	544884 <sup>(18)</sup>	JF	154874G <sup>(19)</sup>	154874 <sup>(19)</sup>	SC
L426  H 00005601 →	09.86 » 91	544884G <sup>(18)</sup>	544884 <sup>(18)</sup>	JF	154874G <sup>(19)</sup>	154874 <sup>(19)</sup>	SC
L42D, L42E, L42L, L42N	09.86 » 91	544884G <sup>(18)</sup>	544884 <sup>(18)</sup>	JF	154874G <sup>(19)</sup>	154874 <sup>(19)</sup>	SC
L42F  D 00000526 →	09.86 » 91	544884G <sup>(18)</sup>	544884 <sup>(18)</sup>	JF	154874G <sup>(19)</sup>	154874 <sup>(19)</sup>	SC
B375 (Turbo)  D 00001344 → Except Zender	09.86 » 91	544884G <sup>(18)</sup>	544884 <sup>(18)</sup>	JF	154874G <sup>(19)</sup>	154874 <sup>(19)</sup>	SC
B376  E 00043790 →	09.86 » 91	544884G <sup>(18)</sup>	544884 <sup>(18)</sup>	JF	154874G <sup>(19)</sup>	154874 <sup>(19)</sup>	SC
B376  D 00017727 →	84 » 91	544884G <sup>(18)</sup>	544884 <sup>(18)</sup>	JF	154874G <sup>(19)</sup>	154874 <sup>(19)</sup>	SC
B37D, B37E, B37L, B37N	09.86 » 91	544884G <sup>(18)</sup>	544884 <sup>(18)</sup>	JF	154874G <sup>(19)</sup>	154874 <sup>(19)</sup>	SC
B37F  D 00000645 →	09.86 » 91	544884G <sup>(18)</sup>	544884 <sup>(18)</sup>	JF	154874G <sup>(19)</sup>	154874 <sup>(19)</sup>	SC
C375 (Turbo)  D 00007887 → Except Zender	09.86 » 91	544884G <sup>(18)</sup>	544884 <sup>(18)</sup>	JF	154874G <sup>(19)</sup>	154874 <sup>(19)</sup>	SC
C375 (Turbo)  E 00002301 → Except Zender	09.86 » 91	544884G <sup>(18)</sup>	544884 <sup>(18)</sup>	JF	154874G <sup>(19)</sup>	154874 <sup>(19)</sup>	SC
C376  D 00006419 →	09.86 » 91	544884G <sup>(18)</sup>	544884 <sup>(18)</sup>	JF	154874G <sup>(19)</sup>	154874 <sup>(19)</sup>	SC
C37D, C37E, C37L, C37N	09.86 » 91	544884G <sup>(18)</sup>	544884 <sup>(18)</sup>	JF	154874G <sup>(19)</sup>	154874 <sup>(19)</sup>	SC
C37 F  D 00000510 →	09.86 » 91	544884G <sup>(18)</sup>	544884 <sup>(18)</sup>	JF	154874G <sup>(19)</sup>	154874 <sup>(19)</sup>	SC
<b>RENAULT R12</b>							
<b>R12</b>							
Berline/Saloon  	69 » 04.70				174185G	174185	SC
Berline/Saloon  	05.70 » 81	364188G	364188	SR	174185G	174185	SC











MODELE MODEL	ANNEE / YEAR						
		AVANT / FRONT			ARRIÈRE / REAR		
		GAZ / GAS	HYD	TYPE	GAZ / GAS	HYD	TYPE
<b>RENAULT R14</b>							
<b>R14</b>							
 R1210 (  → 345946	76 » 09.78	444397G	444397	FU	254293G	254293	GC
 R1211 (  → 007532	76 » 09.78	444397G	444397	FU	254293G	254293	GC
 R1210 (  345947 →	10.78 » 85	444742G	444742	FU	254293G	254293	GC
 R1211 (  007533 →	10.78 » 85	444742G	444742	FU	254293G	254293	GC
 R1212, R1213 (  000001 →	79 » 85	444742G	444742	FU	254293G	254293	GC
<b>RENAULT R15 - R17</b>							
<b>R15, R17</b>							
	71 » 81	364188G	364188	SR	174185G	174185	SC
<b>RENAULT R16</b>							
<b>R16</b>							
	64 » 81	141980G	141980	SC	151991G	151991	SC
<b>RENAULT R18 Berline/Saloon 4 Portes/Doors</b>							
<b>R18</b>							
 R1340 L, TL, GTL (  → 552000	78 » 83	(20) 364501G	(20) 364501	SR	174502G	174502	SC
 R1341 GTL, TS, GTS (  → 559400	8378 »	(20) 364501G	(20) 364501	SR	174502G	174502	SC
 R1342 TS, GTS (  010710 (  → 020609	08.82 » 83	(20) 364501G	(20) 364501	SR	174502G	174502	SC
 R1349 TL	78 » 83	(20) 364501G	(20) 364501	SR	174502G	174502	SC



































MODELE MODEL	ANNEE / YEAR						
		AVANT / FRONT			ARRIÈRE / REAR		
		GAZ / GAS	HYD	TYPE	GAZ / GAS	HYD	TYPE
<b>R18</b>							
 R1342 TS - GTS (  ) → 010709	» 07.82	(20) 364814G	(20) 364814	SR	174502G	174502	SC
 R1343 TX, GTX (  ) → 003200	» 07.82	(20) 364814G	(20) 364814	SR	174502G	174502	SC
 R1344 TD, GTD (  ) → 190905	80 » 83	(20) 364814G	(20) 364814	SR	174502G	174502	SC
 R1340, TL, GTL (  ) 552001 →	84 » 87	(20) 364795G	(20) 364795	SR	174502G	174502	SC
 R1341 GTL, TS, GTS (  ) 559401 →	84 » 87	(20) 364795G	(20) 364795	SR	174502G	174502	SC
 R1342 TS, GTS (  ) 020610 →	84 » 87	(20) 364795G	(20) 364795	SR	174502G	174502	SC
 R1343 TX, GTX (  ) 003201 →	08.82 » 87	(20) 364795G	(20) 364795	SR	174502G	174502	SC
 R1344 TD, GTD (  ) 190906 →	84 » 87	(20) 364795G	(20) 364795	SR	174502G	174502	SC
 R1345 Turbo, Essence/Petrol	81 » 87	(20) 364795G	(20) 364795	SR	174502G	174502	SC
 R1346 Turbo Diesel	84 » 87	(20) 364795G	(20) 364795	SR	174502G	174502	SC
 R134A Turbo Injection, Essence/Petrol	81 » 87	(20) 364795G	(20) 364795	SR	174502G	174502	SC



MODELE MODEL	ANNEE / YEAR						
		AVANT / FRONT			ARRIÈRE / REAR		
		GAZ / GAS	HYD	TYPE	GAZ / GAS	HYD	TYPE
<b>RENAULT R18 Break/Estate (4x2)</b>							
<b>R18</b>							
R1350 TL  → 122600	79 » 84	(20) 364501G	(20) 364501	SR	174502G	174502	SC
  R1351 GTL, LS, TS, GTS  → 118200 Except 	79 » 84	(20) 364501G	(20) 364501	SR	174502G	174502	SC
  R1352  → 003929 TS, GTS	79 » 84	(20) 364501G	(20) 364501	SR	174502G	174502	SC
  R1359 TL  → 000200	79 » 84	(20) 364501G	(20) 364501	SR	174502G	174502	SC
  R2350 Société/Van  → 004600	79 » 84	(20) 364501G	(20) 364501	SR	174502G	174502	SC
  R1353 TX, GTX Except   → 002000	» 06.82	(20) 364814G	(20) 364814	SR	174502G	174502	SC
  R1354 TD, GTD Except   → 063219	82 » 83	(20) 364814G	(20) 364814	SR	174502G	174502	SC
  R2354 Société/Van Diesel  → 003499	82 » 83	(20) 364814G	(20) 364814	SR	174502G	174502	SC
  R1350 TL  122601 →	84 » 87	(20) 364795G	(20) 364795	SR	174502G	174502	SC















MODELE MODEL	ANNEE / YEAR						
		AVANT / FRONT			ARRIÈRE / REAR		
		GAZ / GAS	HYD	TYPE	GAZ / GAS	HYD	TYPE
<b>R18</b>							
  R1351, GTL, LS, TS, GTS Except   118201 →	84 » 87	(20) 364795G	(20) 364795	SR	174502G	174502	SC
  R1352 TS, GTS  003930 →	84 » 87	(20) 364795G	(20) 364795	SR	174502G	174502	SC
  R1353 TX, GTX Except   002001 →	07.82 » 87	(20) 364795G	(20) 364795	SR	174502G	174502	SC
  R1354 TD, GTD Except   063220 →	84 » 87	(20) 364795G	(20) 364795	SR	174502G	174502	SC
  R1355 Turbo Essence/Petrol	82 » 87	(20) 364795G	(20) 364795	SR	174502G	174502	SC
  R1356 Turbo Diesel	82 » 87	(20) 364795G	(20) 364795	SR	174502G	174502	SC
  R1359 TL  000201 →	84 » 87	(20) 364795G	(20) 364795	SR	174502G	174502	SC
  R135A, R135B Turbo Injection Essence/Petrol	82 » 87	(20) 364795G	(20) 364795	SR	174502G	174502	SC
  R2350 Société/Van  004601 →	84 » 87	(20) 364795G	(20) 364795	SR	174502G	174502	SC
  R2354 Société/Van Diesel  003500 →	84 » 87	(20) 364795G	(20) 364795	SR	174502G	174502	SC



















MODELE MODEL	ANNEE / YEAR						
		AVANT / FRONT			ARRIÈRE / REAR		
		GAZ / GAS	HYD	TYPE	GAZ / GAS	HYD	TYPE
<b>RENAULT R19 &amp; R19 CHAMADE</b>							
<b>R19</b>							
 1237cc, 1390cc (TS, GTS, TSE, Europa, Prima) Except Turbo (D, DX)	88 » 93	544039G	544039	JF	154030G	154030	SC
 1397cc (TR, GTR, TRE, Prima) Except Turbo (D, DX)	88 » 93	544039G	544039	JF	154030G	154030	SC
 1870cc Diesel (TD, GTD, TDE, Europa D-Prima D) Except Turbo (D, DX)	88 » 93	544039G	544039	JF	154030G	154030	SC
 1721cc (GTX, TXE, TXi)	88 » 93	544039G	544039	JF	154041G	154041	SC
 1870cc Turbo Diesel (D, DX)	88 » 93	544039G	544039	JF	154041G	154041	SC
 1764cc 16V	88 » 93	545260G	545260	JF	154041G	154041	SC
 1390cc (1.4, 1.4e) RL, RN, Europa, Latitude, Prima, Storia	93 »	544039G	544039	JF	154030G	154030	SC
 1397cc (1.4, 1.4i) RL	93 »	544039G	544039	JF	154030G	154030	SC
 1870cc Diesel (1.9 D) RL, RN, RT	93 »	544039G	544039	JF	154030G	154030	SC
 1870cc Diesel (1.9 D) Europa, Latitude, Prima, Storia	93 »	544039G	544039	JF	154030G	154030	SC
 1794cc (1.8, 1.8i) RN, RT, Alizé, Baccara	93 »	544039G	544039	JF	154041G	154041	SC
 1870cc Diesel Turbo (1.9 DT) RL, RN, RT	93 »	544039G	544039	JF	154041G	154041	SC















MODELE MODEL	ANNEE / YEAR						
		AVANT / FRONT			ARRIÈRE / REAR		
		GAZ / GAS	HYD	TYPE	GAZ / GAS	HYD	TYPE
<b>R19</b>							
 1870cc Diesel Turbo (1.9 DT) Alizé, Latitude, Storia	93 »	544039G	544039	JF	154041G	154041	SC
 1764cc, 1794cc 16V	93 »	545260G	545260	JF	154041G	154041	SC
 Tous All Models 1721cc Except 16V	88 » 93	544039G	544039	JF	154041G	154041	SC
 1721cc 16V	88 » 93	545260G	545260	JF	154041G	154041	SC
 Tous All Models 1764cc, 1783cc, 1794cc Except 16V, RSi	93 »	544039G	544039	JF	154041G	154041	SC
 1764cc, 1783cc, 1794cc 16V, RSi	93 »	545260G	545260	JF	154041G	154041	SC
<b>RENAULT R20</b>							
<b>R20</b>							
R1271 L, TL, GTL  → 187000	75 » 80		364407	SR	554923G	554923	JF
R1271 L, TL, GTL  187001 →	80 » 84	364865G	364865	SR	554923G	554923	JF
R1272 LS, TS	75 » 85	364399G	364399	SR	554923G	554923	JF
R1277 LS, TS	80 » 85	364865G	364865	SR	554923G	554923	JF
R1279 TX	80 » 85	364847G	364847	SR	554923G	554923	JF
R1270, R 1276 Diesel TD, GTD, Turbo diesel	79 » 85	364865G	364865	SR	554923G	554923	JF
<b>RENAULT R21 Berline/Saloon (4x2)</b>							
<b>R21</b>							
   B481, L481 (TL, GTL)	86 » 95	544981G	544981	JF	114984G	114984	SC











MODELE MODEL	ANNEE / YEAR						
		AVANT / FRONT			ARRIÈRE / REAR		
		GAZ / GAS	HYD	TYPE	GAZ / GAS	HYD	TYPE
<b>R21</b>							
   B482, B484, B48D, B48E, B48F, B48H, B48i, B48J, B48M, B48N, B48U	86 » 95	544981G	544981	JF	214997G	214997	GC
   L482, L484, L48D, L48E, L48F, L48H, L48i, L48J, L48M, L48N, L48U (RS, TS, GTS, TSE, SD, GSD...)	86 » 95	544981G	544981	JF	214997G	214997	GC
   B480, B483, B486, B487, B488, B489, B48A, B48C, B48K, B48O, B48P, B48R, B48V, B48W, B48Y (RX, TX, GTX, TXE, Ti, TXi, Baccara, TD, GTD, Turbo D, DX...)	86 » 95	544982G L 544983G R	544982 L 544983 R	JF	214997G	214997	GC
   L480, L483, L486, L487, L488, L489, L48A, L48C, L48K, L48O, L48P, L48Q, L48R, L48S, L48V, L48W, L48Y (RX, TX, GTX, TXE, Ti, TXi, Baccara, TD, GTD, Turbo D, DX...)	86 » 95	544982G L 544983G R	544982 L 544983 R	JF	214997G	214997	GC
<b>RENAULT R21 Break/Estate (4x2)</b>							
<b>R21 NEVADA &amp; SAVANNA</b>							
Brake/Estate  K481, K482, K484, K48E, K48F, K48H, K48i, K48J, K48M, K48N, K48U, S481, S482, S48H (TL, GTL, TS, GTS, RN, RT1.7, RX1.6, SD, GSD...)	86 »	544981G	544981	JF	613214G	613214	RC
Brake/Estate  K480, K483, K486, K487, K488, K489, K48A, K48B, K48C, K48K, K48O, K48P, K48R, K48S, K48V, K48W, S486, S48O, S48V (RX, GTX, TXE, TXi, RN, RT 2.1, RTi, TD, GTD, Turbo D, DX...)	86 »	544982G L 544983G R	544982 L 544983 R	JF	613214G	613214	RC
<b>RENAULT R25</b>							
<b>R25</b>							
 Except V6, Turbo Diesel	84 » 93	364920G	364920	SR	554931G	554931	JF
V6, Turbo Diesel <sup>(13)</sup>	84 » 93	364973G	364973	SR	554931G	554931	JF

















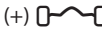





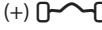





MODELE MODEL	ANNEE / YEAR						
		AVANT / FRONT			ARRIÈRE / REAR		
		GAZ / GAS	HYD	TYPE	GAZ / GAS	HYD	TYPE
<b>RENAULT R30</b>							
<b>R30</b>							
R1273, R1275 TS	75 » 84	364399G	364399	SR	554923G	554923	JF
R1278 TX  → 22200	76 » 06.80	364399G	364399	SR	554923G	554923	JF
R1278 TX  22201 →	07.80 » 84	364847G	364847	SR	554923G	554923	JF
R1270 Turbo Diesel	81 » 84	364865G	364865	SR	554923G	554923	JF
<b>RENAULT SAFRANE (4x2)</b>							
<b>SAFRANE I &amp; II</b>							
 <sup>(13)</sup>	91 »	545233G	545233	JF	555235G	555235	JF
<b>RENAULT SB SERIES</b>							
<b>SB2</b>							
 (Fourgon bas/Lower van) 4.2 Tonnes	67 »		841899	PL		871890	PL
<b>RENAULT SCENIC I</b>							
<b>SCENIC I</b>							
(JA)  1.4	96 » 06.98	545295G	545295	JF	215436G	215436	SC
(JA)  1.6 Except <b>A</b>	96 » 06.98	545295G	545295	JF	215436G	215436	SC
(JA)  1.6 (+) <b>A</b>	96 » 06.98	545435G	545435	JF	215436G	215436	SC
(JA)  1.9D, 1.9DT Except dTi	96 » 05.03	545435G	545435	JF	215436G	215436	SC
(JA)  1.9 dTi, 2.0	96 » 06.98	545435G	545435	JF	215436G	215436	SC





















MODELE MODEL	ANNEE / YEAR						
		AVANT / FRONT			ARRIÈRE / REAR		
		GAZ / GAS	HYD	TYPE	GAZ / GAS	HYD	TYPE
<b>SCENIC I</b>							
(JA)  1.4, 1.6, 1.8, 1.9 (D, DT, dCi, dTi), 2.0	07.98 » 05.03	545295G	545295	JF	215436G	215436	SC
RX4 1.9 dCi, 2.0 16V	00 » 05.03	545562G	545562	JF	215530G	215530	GC
<b>RENAULT SCENIC II</b>							
<b>SCENIC II</b>							
(JM) Court/Short = 4.25 (5 Sièges/Seats) Except 	06.03 » 04.09	545699G	545699	JF	215623G	215623	GC
<b>GRAND SCENIC II</b>							
(JM) Long = 4.47 (7 Sièges/Seats) Except 	06.03 » 03.09	545699G	545699	JF	215724G	215724	GC
<b>RENAULT SCENIC III</b>							
<b>SCENIC III</b>							
 Except Xmod	05.09 »	545852G	545852	JF	215623G	215623	GC
<b>GRAND SCENIC III</b>							
 Except Xmod	04.09 »	545852G	545852	JF	215853G	215853	GC
<b>RENAULT SG SERIES</b>							
<b>SG1 - SG2</b>							
SR 210 → 240 Goelette, Super Goelette  Except SR 211	65 »	761878G	761878	PLL	751879G	751879	PLL
<b>SG2</b>							
SR 211 Tropique	71 »	801909G	801909	PL			
<b>SG3</b>							
Except Châssis 262-27, 262-31	72 »	701059G	701059	PLL	714744G	714744	PLL
<b>SG4</b>							
SR 410 → 480 Super Galion Except SR 411	66 »	761878G	761878	PLL	771659G	771659	PLL
SR 411 Tropique	71 »	801909G	801909	PL			

























MODELE MODEL	ANNEE / YEAR						
		AVANT / FRONT			ARRIÈRE / REAR		
		GAZ / GAS	HYD	TYPE	GAZ / GAS	HYD	TYPE
<b>SG5</b>							
7.3 Tonnes	69 »	701059G	701059	PLL	774231G	774231	PLL
<b>RENAULT SYMBOL</b>							
<b>SYMBOL III</b>							
 (-)  (-) 	11.12 »	545892G	545892	JF	155893G	155893	SC
 (+)  (-) 	11.12 »	545891G	545891G	JF	155893G	155893	SC
 (-)  (+) 	11.12 »	545878G	545878	JF	155893G	155893	SC
 (+)  (+) garde au sol augmentée	11.12 »	545908G	545908	JF	155893G	155893	SC
<b>RENAULT TRAFIC I - PROPULSION/RWD - 4x2 (Series P)</b>							
<b>TRAFIC I</b>							
(Series P), P3 PROPULSION/RWD    → 3373	80 » 82	544959G L 544958G R	544959 L 544958 R	JF			
(Series P), P5 PROPULSION/RWD  Microcar  → 0224	80 » 82	544959G L 544958G R	544959 L 544958 R	JF			
(Series P), P6 PROPULSION/RWD  Microcar  → 0105	80 » 82	544959G L 544958G R	544959 L 544958 R	JF			
(Series P), P8 PROPULSION/RWD  Microcar  → 0011	80 » 82	544959G L 544958G R	544959 L 544958 R	JF			
(Series P), P3 PROPULSION/RWD    3374 →	82 » 89	544959G L 544958G R	544959 L 544958 R	JF	215117G	215117	GC
(Series P), P5 PROPULSION/RWD  Microcar  0225 →	82 » 86	544959G L 544958G R	544959 L 544958 R	JF	215117G	215117	GC

















MODELE MODEL	ANNEE / YEAR						
		AVANT / FRONT			ARRIÈRE / REAR		
		GAZ / GAS	HYD	TYPE	GAZ / GAS	HYD	TYPE
<b>TRAFIC I</b>							
(Series P), P6 PROPULSION/RWD  Microcar  0106 →	82 » 89	544959G L 544958G R	544959 L 544958 R	JF	215117G	215117	GC
(Series P), P8 PROPULSION/RWD  Microcar  0012 →	82 » 86	544959G L 544958G R	544959 L 544958 R	JF	215117G	215117	GC
(Series P) PROPULSION/RWD  P6C, PA, PC	81 »		545471 L 545472 R	JF	215117G	215117	GC
<b>RENAULT TRAFIC 1 - TRACTION/FWD - 4x2 (Series T)</b>							
<b>TRAFIC 1</b>							
(Series T), T1 TRACTION/FWD   Except Ambulance	80 » 02.89	544959G L 544958G R	544959 L 544958 R	JF	254873G	254873	GC
(Series T), T1 TRACTION/FWD   (Ambulance inclus)	03.89 » 08.01	544959G L 544958G R	544959 L 544958 R	JF	254873G	254873	GC
(Series T), T2, T3 TRACTION/FWD  	80 » 08.01	544959G L 544958G R	544959 L 544958 R	JF	254873G	254873	GC
(Series T), T4 TRACTION/FWD   Except T42, T44, T46, T4C, Ambulance	80 » 02.89	544959G L 544958G R	544959 L 544958 R	JF	254873G	254873	GC
(Series T), T4 TRACTION/FWD  T42, T44, T46, T4C → N° 25720	80 » 12.82	544959G L 544958G R	544959 L 544958 R	JF	254873G	254873	GC
(Series T), T4 TRACTION/FWD   (Ambulance inclus)	03.89 » 08.01	544959G L 544958G R	544959 L 544958 R	JF	254873G	254873	GC



MODELE MODEL	ANNEE / YEAR						
		AVANT / FRONT			ARRIÈRE / REAR		
		GAZ / GAS	HYD	TYPE	GAZ / GAS	HYD	TYPE
<b>TRAFIC 1</b>							
(Series T), T5B TRACTION/FWD   Except T5	89 » 08.01	544959G L 544958G R	544959 L 544958 R	JF	254873G	254873	GC
(Series T) TRACTION/FWD   TF, TG, TH, TJ	86 » 08.01	544959G L 544958G R	544959 L 544958 R	JF	254873G	254873	GC
(Series T) TRACTION/FWD   T42, T44, T46, T4C N° 25721 →	01.83 » 02.89		545471 L 545472 R	JF	254873G	254873	GC
(Series T), T1, T4 TRACTION/FWD   Ambulance	80 » 02.89	544959G L 544958G R	544959 L 544958 R	JF	254962G	254962	GC
(Series T), T5 TRACTION/FWD   Except T5B	80 » 08.01	544959G L 544958G R	544959 L 544958 R	JF	254962G	254962	GC
(Series T) TRACTION/FWD   T6, T7, T9	83 » 08.01	544959G L 544958G R	544959 L 544958 R	JF	254962G	254962	GC
(Series T) TRACTION/FWD   TA, TB, TC, TE, TM	81 » 08.01	544959G L 544958G R	544959 L 544958 R	JF	254962G	254962	GC
(Series T) TX TRACTION/FWD  	80 »	544959G L 544958G R	544959 L 544958 R	JF	254873G 254962G	254873 254962	GC
<b>RENAULT TRAFIC I - 4x4</b>							
<b>TRAFIC I</b>							
(Series V)  	85 » 08.01		545471 L 545472 R	JF	215117G	215117	GC
<b>RENAULT TRAFIC II</b>							
<b>TRAFIC II Phase 1</b>							
(JL)  	09.01 » 06.06	545593G	545593	JF	215597G	215597	GC







MODELE MODEL	ANNEE / YEAR						
		AVANT / FRONT			ARRIÈRE / REAR		
		GAZ / GAS	HYD	TYPE	GAZ / GAS	HYD	TYPE
<b>TRAFIC II Phase 1</b>							
(FL) 	09.01 » 06.06	545593G	545593	JF	215597G	215597	GC
(EL) 	09.01 »	545593G	545593	JF	215597G	215597	GC
<b>RENAULT TRAFIC 3</b>							
<b>TRAFIC II Phase 2</b>							
	07.06 » 04.14		545593	JF	215597G	215597	GC
	07.06 » 04.14		545593	JF	215597G	215597	GC
<b>TRAFIC III</b>							
	05.14 »				215597G	215597	GC
	05.14 »				215597G	215597	GC
	05.14 »				215597G	215597	GC
<b>RENAULT TWINGO</b>							
<b>TWINGO I</b>							
(C0, S0) Phase 1, 2 	93 » 08.00	545189G	545189	JF	355180G	355180	SR
(C0, S0) Phase 3, 4 	09.00 » 05.07	545551G	545551	JF	355180G	355180	SR
<b>TWINGO II</b>							
(CN)  (+) ⊕ Except 1.2 8V "Access", GT, RS	06.07 »	545711G	545711	JF	155712G	155712	SC
(CN)  (-) ⊕ 1.2 8V "Access"	06.07 »	545747G	545747	JF	155712G	155712	SC
<b>TWINGO III</b>							
	09.14 »	545959G	545959	JF	155950G	155950	SC
<b>RENAULT VOLTIGEUR</b>							
<b>VOLTIGEUR</b>							
R 2065, R 4065 Ressorts à lames	05.59 »		261621	GC		251622	GC
<b>ROVER</b>							
<b>25 SERIES</b>							
(RF)	99 »				355362G	355362	SR







ROVER





SAAB

MODELE MODEL	ANNEE / YEAR						
		AVANT / FRONT			ARRIÈRE / REAR		
		GAZ / GAS	HYD	TYPE	GAZ / GAS	HYD	TYPE
<b>100 SERIES</b>							
(XP) GTa, GTi	90 »	144870G	144870	SC			
<b>200 SERIES</b>							
(RF)  Except 200 Vi, BRM	10.95 »				355362G	355362	SR
(RF)  200 Vi, BRM	10.95 »	545547G	545547	JF	355548G	355548	SR
(XW)  N° 911248 → Except Cabrio	10.95 »				355362G	355362	SR
<b>P6 SERIES</b>							
2000, 2200, 3500 (V8 inclus)	63 » 78	101623G	101623	SC	171624G	171624	SC
<b>SD1 SERIES</b>							
2000, 2300 Except Vitesse	76 » 87	444749G	444749	FU	274844G	274844	GC
2400 (Turbo D inclus) Except Vitesse	82 » 87	444749G	444749	FU			
2600, 3500 Except Vitesse	76 » 87	444749G	444749	FU			













## SAAB

<b>SAAB 90 --&gt; 99</b>							
<b>90</b>							
 (F+D) → G6000885	» 09.84		101828	SC		154654	SC
 (F+D) G6000886 →	10.84 » 88					154654	SC
<b>93 &amp; 95</b>							
	56 » 78		101475	SC			
<b>96</b>							
750GT, 850, 896 Sport inclus	60 » 79		101475	SC	141525G	141525	SC
<b>97</b>							
Sonett	67 » 74		101475	SC	141525G	141525	SC





















MODELE MODEL	ANNEE / YEAR						
		AVANT / FRONT			ARRIÈRE / REAR		
		GAZ / GAS	HYD	TYPE	GAZ / GAS	HYD	TYPE
<b>99</b>							
	67 » 04,78		101828	SC	171829G	171829	SC
	05.78 » 87		101828	SC		154654	SC
<b>SAAB 600 --&gt; 900</b>							
<b>900</b>							
	78 » 93		144653	SC		154654	SC





















## SEAT

<b>SEAT 124 --&gt; 133</b>							
<b>124</b>							
 Pamplona, Serie I	66 »	141628G	141628	SC	151629G	151629	SC
 Pamplona, Serie II	68 »	141628G	141628	SC	151801G	151801	SC
	67 »	141628G	141628	SC	111867G	111867	SC
<b>127 - FURA</b>							
 Except Crono	71 »	544825G	544825	JF	554851G	554851	JF
Crono	71 »				554851G	554851	JF
<b>128</b>							
	77 »				554852G	554852	JF
<b>131</b>							
 Essence/Petrol, Diesel	74 » 12.78	544810G	544810	JF	151801G	151801	SC
 Essence/Petrol	01.79 » 09.81	544821G	544821	JF	151801G	151801	SC
 Essence/Petrol	10.81 »				151801G	151801	SC
 Diesel	01.79 » 09.81	544811G	544811	JF	151801G	151801	SC
 Diesel	10.81 »				151801G	151801	SC
 Essence/Petrol, Diesel	74 » 12.78	544810G	544810	JF	114829G	114829	SC
 Essence/Petrol	01.79 » 09.81	544821G	544821	JF	114829G	114829	SC
 Essence/Petrol	10.81 »				114829G	114829	SC



















MODELE MODEL	ANNEE / YEAR						
		AVANT / FRONT			ARRIÈRE / REAR		
		GAZ / GAS	HYD	TYPE	GAZ / GAS	HYD	TYPE
<b>131</b>							
 Diesel	01.79 » 09.81	544811G	544811	JF	114829G	114829	SC
 Diesel	10.81 »				114829G	114829	SC
<b>132</b>							
	72 » 82	141601G	141601	SC	154110G	154110	SC
<b>133</b>							
	73 »	121572G	121572	SC	131573G	131573	SC
<b>SEAT 600 --&gt; 1430</b>							
<b>600 D - 800</b>							
	64 »				171386G	171386	SC
<b>850</b>							
	65 »	121572G	121572	SC	131573G	131573	SC
<b>1200 - 1430</b>							
Sport					554851G	554851	JF
<b>SEAT ALHAMBRA</b>							
<b>ALHAMBRA 1</b>							
 	95 » 08.10	545336G	545336	JF	115337G	115337	SC
<b>ALHAMBRA 2</b>							
 	09.10	545612G	545612	JF	115337G	115337	GC
<b>SEAT ALTEA</b>							
<b>ALTEA</b>							
(5P)   Court/Short, Long (XL) Tube Jambe de Force : Ø Externe = 50mm. Strut outer Tube : External Ø (OD) = 50mm. Except (SS), Quattro Except 	04 »	545611G	545611	JF	255613G	255613	GC
(5P)   Court/Short, Long (XL) Tube Jambe de Force : Ø Externe = 55mm. Strut outer Tube : External Ø (OD) = 55mm. Except (SS), Quattro Except 	04 »	545612G	545612	JF	255613G	255613	GC















MODELE MODEL	ANNEE / YEAR						
		AVANT / FRONT			ARRIÈRE / REAR		
		GAZ / GAS	HYD	TYPE	GAZ / GAS	HYD	TYPE
<b>SEAT AROSA</b>							
<b>AROSA</b>							
(6H) 	97 » 11.11	<sup>(2) (3)</sup> 545201G	<sup>(2) (3)</sup> 545201	JF	155467G	155467	SC
<b>SEAT CORDOBA</b>							
<b>CORDOBA 1</b>							
(6K)  Except 16V, GT(i), Diesel  → 6K.TR080.000	93 » 04.94	<sup>(2)</sup> 544091G	<sup>(2)</sup> 544091	JF	<sup>(4)</sup> 355242G	<sup>(4)</sup> 355242	SR
(6K)  Except 16V, GT(i), Diesel.  6K.TR080.001 →	05.94 » 12.97	<sup>(2)</sup> 545201G	<sup>(2)</sup> 545201	JF	<sup>(4)</sup> 355242G	<sup>(4)</sup> 355242	SR
(6K) 16V, GT, GTi	93 » 12.97	<sup>(2)</sup> 544092G	<sup>(2)</sup> 544092	JF	<sup>(4)</sup> 355237G	<sup>(4)</sup> 355237	SR
(6K) Diesel 1.9 D, TD, Tdi	93 » 12.97	<sup>(2)</sup> 544092G	<sup>(2)</sup> 544092	JF	<sup>(4)</sup> 355242G	<sup>(4)</sup> 355242	SR
(6K)   1.4, 1.6	01.98 » 09.99	<sup>(2)</sup> 545201G	<sup>(2)</sup> 545201	JF	<sup>(4)</sup> 355242G	<sup>(4)</sup> 355242	SR
(6K)   1.9 SDi, TDi	01.98 » 09.99	<sup>(2)</sup> 544092G	<sup>(2)</sup> 544092	JF	<sup>(4)</sup> 355242G	<sup>(4)</sup> 355242	SR
(6K)   2.0 16V	01.98 » 09.99	<sup>(2)</sup> 544092G	<sup>(2)</sup> 544092	JF	<sup>(4)</sup> 355237G	<sup>(4)</sup> 355237	SR
(6K)   1.4, 1.6, 1.9 (SDi, TDi) Except 	10.99 » 09.02	<sup>(2)</sup> 545201G	<sup>(2)</sup> 545201	JF	<sup>(4)</sup> 355538G	<sup>(4)</sup> 355538	SR
(6K)    1.4, 1.6, 1.9 SDi	10.99 » 09.02	<sup>(2)</sup> 544092G	<sup>(2)</sup> 544092	JF	<sup>(4)</sup> 355538G	<sup>(4)</sup> 355538	SR
(6K)  1.4, 1.6, 1.9 (SDi, TDi)	97 » 03	<sup>(2)</sup> 545201G	<sup>(2)</sup> 545201	JF	<sup>(4)</sup> 355538G	<sup>(4)</sup> 355538	SR





























MODELE MODEL	ANNEE / YEAR						
		AVANT / FRONT			ARRIÈRE / REAR		
		GAZ / GAS	HYD	TYPE	GAZ / GAS	HYD	TYPE
<b>CORDOBA 2</b>							
(6L)  Except (SS)	10.02 »	(5) 545566G	(5) 545566	JF	155567G	155567	SC
<b>SEAT EXEO</b>							
<b>EXEO</b>							
(3R)  Except 	09 »	345644G	345644	SR	155647G	155647	SC
<b>EXEO ST</b>							
(3R)  Except 	09 »	345644G	345644	SR	155647G	155647	SC
<b>SEAT IBIZA</b>							
<b>IBIZA I</b>							
(1A)   → 9146536	84 » 03.86	544906G	544906	JF	554769G	554769	JF
(1A)   9146537 →	04.86 » 08.89	544049G	544049	JF	554769G	554769	JF
(1A) 	09.89 » 04.93	545133G	545133	JF	554769G	554769	JF
<b>IBIZA II</b>							
(6K)  Except 16V, GTi, Diesel  → 6K.TR080.000	05.93 » 04.94	(2) 544091G	(2) 544091	JF	(4) 355242G	(4) 355242	SR
(6K)  Except 16V, GTi, Diesel  6K.TR080.001 →	05.94 » 12.97	(2) 545201G	(2) 545201	JF	(4) 355242G	(4) 355242	SR
(6K) 16V, GT(i)	05.93 » 12.97	(2) 544092G	(2) 544092	JF	(4) 355237G	(4) 355237	SR
(6K) Diesel, 1.9D, TD, TDi	05.93 » 12.97	(2) 544092G	(2) 544092	JF	(4) 355242G	(4) 355242	SR
(6K) 1.0, 1.4, 1.6	01.98 » 09.99	(2) 545201G	(2) 545201	JF	(4) 355242G	(4) 355242	SR
(6K) 1.9 SDi, TDi	01.98 » 09.99	(2) 544092G	(2) 544092	JF	(4) 355242G	(4) 355242	SR























MODELE MODEL	ANNEE / YEAR						
		AVANT / FRONT			ARRIÈRE / REAR		
		GAZ / GAS	HYD	TYPE	GAZ / GAS	HYD	TYPE
<b>IBIZA II</b>							
(6K) 2.0 16V	01.98 » 09.99	544092G <sup>(2)</sup>	544092 <sup>(2)</sup>	JF	355237G	355237	SR
<b>IBIZA III</b>							
(6K)  Except (SS)	10.99 » 01.02	545201G <sup>(2)</sup>	545201 <sup>(2)</sup>	JF	355538G <sup>(4)</sup>	355538 <sup>(4)</sup>	SR
(6K) (+) (SS) Except 1.8 20V/VT, 1.9 TDi  , 2.0 GTi, Cupra	10.99 » 01.02	544092G <sup>(2)</sup>	544092 <sup>(2)</sup>	JF	355538G <sup>(4)</sup>	355538 <sup>(4)</sup>	SR
<b>IBIZA IV</b>							
(6L)  Except (SS)	02.02 » 03.08	545566G <sup>(5)</sup>	545566 <sup>(5)</sup>	JF	155567G <sup>(5)</sup>	155567 <sup>(5)</sup>	SC
(6L) COLLECTOR 	04.08 »	545566G <sup>(5)</sup>	545566 <sup>(5)</sup>	JF	155567G <sup>(5)</sup>	155567 <sup>(5)</sup>	SC
<b>IBIZA V</b>							
(6J5)  Except (SS), FR	04.08 »	545751G <sup>(5)</sup>	545751 <sup>(5)</sup>	JF	155567G <sup>(5)</sup>	155567 <sup>(5)</sup>	SC
<b>IBIZA 5 ST</b>							
(6J8)  Except (SS)	05.10 »	545751G <sup>(5)</sup>	545751 <sup>(5)</sup>	JF	155567G <sup>(5)</sup>	155567 <sup>(5)</sup>	SC
<b>SEAT INCA</b>							
<b>INCA</b>							
(6K, 9K) 	95 »	545201G <sup>(3)</sup>	545201 <sup>(3)</sup>	JF	115200	115200	SC
<b>SEAT LEON</b>							
<b>LEON 1</b>							
(1M)  Except (SS), 1.8 20VT Except 	<sup>(8)</sup> 98 » 08.05	545274G <sup>(6)</sup>	545274 <sup>(6)</sup>	JF	155275G <sup>(6)</sup>	155275 <sup>(6)</sup>	SC
(1M)  (+) (SS) Except 1.8 20VT Except 	<sup>(8)</sup> 98 » 08.05	545274G <sup>(6)</sup>	545274 <sup>(6)</sup>	JF	155464G <sup>(6)</sup>	155464 <sup>(6)</sup>	SC

















MODELE MODEL	ANNEE / YEAR						
		AVANT / FRONT			ARRIÈRE / REAR		
		GAZ / GAS	HYD	TYPE	GAZ / GAS	HYD	TYPE
<b>LEON 2</b>							
(1P)   Tube Jambe de Force : Ø Externe = 50mm/Strut outer Tube : External Ø (OD) = 50mm Except (SS), FR, Cupra Except 	(8) 09.05 » 08.12	(7) 545611G	(7) 545611	JF	(7) 255613G	(7) 255613	GC
(1P)   Tube Jambe de Force : Ø Externe = 55mm/Strut outer Tube : External Ø (OD) = 55mm Except (SS), FR, Cupra Except 	(8) 09.05 » 08.12	(7) 545612G	(7) 545612	JF	(7) 255613G	(7) 255613	GC
<b>LEON 3 &amp; LEON 3 ST</b>							
(5F)   ST:    Ø = 50mm Ø = 50mm Except  Except (SS), FR, Cupra Except 	(8) 09.12 »	545809G	545809	JF	255911G	255911	GC
(5F)   ST:    Ø = 55mm Ø = 55mm Except  Except (SS), FR, Cupra Except 	(8) 09.12 »	545800G	545800	JF	255911G	255911	GC
(5F) -  Berline/Saloon ST -(5F) -   /SportTourer Ø = 50mm Ø = 50mm  AR/Rear Except (SS), FR, Cupra, Except 	(8) 09.12 »	545809G	545809	JF	255924G	255924	GC



























MODELE MODEL	ANNEE / YEAR						
		AVANT / FRONT			ARRIÈRE / REAR		
		GAZ / GAS	HYD	TYPE	GAZ / GAS	HYD	TYPE
<b>LEON 3 &amp; LEON 3 ST</b>							
(5F) -  Berline/Saloon <sup>(8)</sup> ST-(5F) -   /SportTourer Ø = 55mm Ø = 55mm  AR/Rear Except  , FR, Cupra, Except 	09.12 »	545800G	545800	JF	255924G	255924	GC
<b>SEAT MALAGA / CREDOS</b>							
<b>MALAGA / CREDOS</b>							
(3A)   → 9071599	85 » 09.86	544906G	544906	JF	554769G	554769	JF
(3A)   9071600 →	10.86 » 08.89	544049G	544049	JF	554769G	554769	JF
(3A) 	09.89 »	545133G	545133	JF	554769G	554769	JF
<b>SEAT MARBELLA &amp; PANDA</b>							
<b>MARBELLA</b>							
	86 » 03.89	544915G <sup>(2)</sup>	544915 <sup>(2)</sup>	JF	114916G	114916	SC
	04.89 »	545473G <sup>(2)</sup>	545473 <sup>(2)</sup>	JF	114916G	114916	SC
<b>PANDA</b>							
	80 »	544915G <sup>(2)</sup>	544915 <sup>(2)</sup>	JF	114916G	114916	SC
<b>SEAT RONDA , RITMO</b>							
<b>RONDA &amp; RITMO</b>							
 Except Crono	78 » 12.83	544828G	544828	JF	554769G	554769	JF
Crono	78 » 12.83	544828G	544828	JF			
<b>RONDA</b>							
(2A)  Except Crono	01.84 »	544906G	544906	JF	554769G	554769	JF
(2A) Crono	01.84 »	544906G	544906	JF			
<b>SEAT TERRA &amp; TRANS</b>							
<b>TERRA</b>							
(24) 	87 » 03.89	544915G <sup>(2)</sup>	544915 <sup>(2)</sup>	JF	114916G	114916	SC
(24) 	04.89 »	545473G <sup>(2)</sup>	545473 <sup>(2)</sup>	JF	114916G	114916	SC



















MODELE MODEL	ANNEE / YEAR						
		AVANT / FRONT			ARRIÈRE / REAR		
		GAZ / GAS	HYD	TYPE	GAZ / GAS	HYD	TYPE
<b>TRANS</b>							
(24) 	85 »	(2) 544915G	(2) 544915	JF	114916G	114916	SC
<b>SEAT TOLEDO</b>							
<b>TOLEDO I</b>							
(1L)   → 1L.ZR054.999 Except 1.8 GT(i) 16V, 2.0 GTi 16V, 2.0i 16V	91 » 08.95	(2) 544091G	(2) 544091	JF	354952G	354952	SR
(1L) 1.8 GTi 16V, 2.0 GTi 16V  → 1L.ZR054.999	91 » 08.95	(2) 544092G	(2) 544092	JF	354952G	354952	SR
(1L)   1L.TR000.001 → Except 1.9 TDi, 2.0 16V, 2.0 GT	09.95 » 02.99	(2) 545201G	(2) 545201	JF	354952G	354952	SR
(1L) 1.9 TDi  1L.TR000.001 →	09.95 » 02.99	(2) 544092G	(2) 544092	JF	354952G	354952	SR
<b>TOLEDO II</b>							
(1M)  Except (SS), 1.8 20VT	03.99 » 08.04	(6) 545274G	(6) 545274	JF	(6) 155275G	(6) 155275	SC
(1M)  (SS) Except 1.8 20VT	03.99 » 08.04	(6) 545274G	(6) 545274	JF	(6) 155464G	(6) 155464	SC
<b>TOLEDO III</b>							
(5P)   Tube Jambe de Force : Ø Externe = 50mm Strut Outer Tube : External Ø (OD) = 50mm Except (SS) Except 	09.04 » 06.12	545611G	545611	JF	255613G	255613	GC





MODELE MODEL	ANNEE / YEAR						
		AVANT / FRONT			ARRIÈRE / REAR		
		GAZ / GAS	HYD	TYPE	GAZ / GAS	HYD	TYPE
<b>TOLEDO III</b>							
(5P)   Tube Jambe de Force : Ø Externe = 55mm Strut Outer Tube : External Ø (OD) = 55mm Except  Except 	09.04 » 06.12	545612G	545612	JF	255613G	255613	GC
<b>TOLEDO IV</b>							
(KG) 	07.12 »	545751G	545751	JF	155934G	155934	SC
<b>SIMCA France</b>							
<b>6</b>							
	47 »		101135	SC	111136G	111136	SC
<b>1000</b>							
  → 180643	» 08.62	141156G	141156	SC	151158G	151158	SC
 Rallye I inclus  → 180644	09.62 » 07.73	141156G	141156	SC	171150G	171150	SC
 Rallye I inclus	08.73 »	141156G	141156	SC	254113G	254113	GC
Rallye II	72 »	141156G	141156	SC	254113G	254113	GC
<b>1100</b>							
  	67 » 80	141721G	141721	SC	151722G	151722	SC
 VF 1	67 » 80	141721G	141721	SC	151722G	151722	SC
 VF 2  → 504388	74 » 76	141721G	141721	SC	151722G	151722	SC
 VF 2  504389 →	76 » 80	144345G <sup>(1)</sup>	144345 <sup>(1)</sup>	SC	154528G	154528	SC
 VF 3	79 »	144345G <sup>(1)</sup>	144345 <sup>(1)</sup>	SC	154528G	154528	SC
	76 »	144345G <sup>(1)</sup>	144345 <sup>(1)</sup>	SC	154528G	154528	SC
<b>1200</b>							
	»	141721G	141721	SC	151722G	151722	SC
<b>1200 S</b>							
Rallye I	» 07.73	141156G	141156	SC	171150G	171150	SC

























MODELE MODEL	ANNEE / YEAR						
		AVANT / FRONT			ARRIÈRE / REAR		
		GAZ / GAS	HYD	TYPE	GAZ / GAS	HYD	TYPE
<b>1300</b>							
 (F+D) → L 080573	63 » 08.64	161163G	161163	SC	171164G	171164	SC
 (F+D) L 080574 →	09.64 » 66	161163G	161163	SC	151539G	151539	SC
<b>1500</b>							
 (F+D) → L 080588	63 » 08.64	161163G	161163	SC	171164G	171164	SC
 (F+D) L 080589 →	09.64 » 66	161163G	161163	SC	151539G	151539	SC
<b>1301 - 1501</b>							
	66 »	161163G	161163	SC	151539G	151539	SC
<b>ARONDE</b>							
Ressorts à lames AR/Rear	51 » 58	141134G	141134	SC	171159G	171159	SC
P 60  AR/Rear	59 » 63	141134G	141134	SC	171135G	171135	SC
<b>ARIANE 4 &amp; 8 - BEAULIEU - CHAMBORD - MARLY - PRESIDENCE - REGENCE - TRIANON - VERSAILLES</b>							
ARIANE 4, 8 - BEAULIEU - CHAMBORD - MARLY - PRESIDENCE - REGENCE - TRIANON - VERSAILLES	55 » 63	441814G	441814	FU	171159G	171159	SC
<b>VEDETTE</b>							
	49 » 55	161141G	161141	SC	171159G	171159	SC
<b>SINGER</b>							
<b>CHAMOIS</b>							
MK I - MK II  	65 » 70					151558	SC
<b>GAZELLE</b>							
MK V, VI 	63 » 66		141561	SC	171159G	171159	SC
<b>NEW GAZELLE</b>							
	67 » 71	441998G	441998	FU			
<b>VOGUE</b>							
MK I → MK IV (F+D) B 7102262 →	61 » 66		141561	SC	171159G	171159	SC
	67 » 70	441998G	441998	FU			
	67 » 70	441998G	441998	FU	111366G	111366	SC



























MODELE MODEL	ANNEE / YEAR						
		AVANT / FRONT			ARRIÈRE / REAR		
		GAZ / GAS	HYD	TYPE	GAZ / GAS	HYD	TYPE



## SKODA

SKODA 100 --> 1050							
100 - 105 - 110 - 120							
	70 » 90	141559G	141559	SC	171829G	171829	SC
130							
	» 83	141559G	141559	SC	171829G	171829	SC
 Rapide, Estelle inclus	84	141559G	141559	SC	174358G	174358	SC
135							
	88 »	141559G	141559	SC	171829G	171829	SC
1000 & 1050							
1000 MB inclus, 1050	64 » 69	141559G	141559	SC	171829G	171829	SC
SKODA FABIA							
FABIA 1							
(6Y)  Except  	99 » 02.10	545563G	545563	JF	155567G	155567	SC
(6Y)  (+)  Except RS, VRS, WRC, 	99 » 02.10	545501G	545501	JF	155503G	155503	SC
(6Y)  (+) 	99 » 02.10	545501G	545501	JF	155502G	155502	SC
(6Y)  Except 	00 » 02.10	545563G	545563	JF	155567G	155567	SC
(6Y)  (+) 	00 » 02.10	545501G	545501	JF	155502G	155502	SC
FABIA 1 PRAKTIK							
 Except 	01 » 07	545563G	545563	JF	155567G	155567	SC
 (+) 	01 » 07	545501G	545501	JF	155502G	155502	SC
FABIA 2							
(542)  Except  	03.10 » 08.14	545563G	545563	JF	155567G	155567	SC



























MODELE MODEL	ANNEE / YEAR						
		AVANT / FRONT			ARRIÈRE / REAR		
		GAZ / GAS	HYD	TYPE	GAZ / GAS	HYD	TYPE
<b>FABIA 2</b>							
(542)  (SS) Except RS, VRS, WRC, 	03.10 » 08.14	545501G	545501	JF	155503G	155503	SC
(542)  (+) 	03.10 » 08.14	545501G	545501	JF	155502G	155502	SC
<b>FABIA 2 COMBI</b>							
(545)  Except  	03.10 » 08.14	545563G	545563	JF	155567G	155567	SC
(545)  (+)  	03.10 » 08.14	545501G	545501	JF	155502G	155502	SC
<b>FABIA 3</b>							
(NJ3)  Except (SS) 	08.14 »	545751G	545751	JF			
(NJ5)  Except (SS) 	08.14 »	545751G	545751	JF			
<b>SKODA FAVORIT</b>							
<b>FAVORIT</b>							
(78) 	88 »	545239G	545239	JF	355230G	355230	SR
<b>FAVORIT / FORMAN</b>							
(78)  	90 »	545239G	545239	JF	355230G	355230	SR
<b>SKODA FELICIA</b>							
<b>FELICIA</b>							
(6U) 	94 »	545351G	545351	JF	355230G	355230	SR
(6U) 	94 »	545351G	545351	JF	355230G	355230	SR
(79) 	95 »	545351G	545351	JF			
<b>SKODA OCTAVIA</b>							
<b>OCTAVIA</b>							
 	67 » 70	141559G	141559	SC			





















MODELE MODEL	ANNEE / YEAR						
		AVANT / FRONT			ARRIÈRE / REAR		
		GAZ / GAS	HYD	TYPE	GAZ / GAS	HYD	TYPE
<b>OCTAVIA 1</b>							
(1U)  Except "Tour", (SS), RS	96 » 05.04	545274G	545274	JF	155275G	155275	SC
(1U)  (+) (SS) Except RS	96 » 05.04	545274G	545274	JF	155464G	155464	SC
(1U)  	98 » 12.04	545274G	545274	JF	155504 <sup>(1)</sup>	155504 <sup>(1)</sup>	SC
(1U)  	98 » 07.00	545274G	545274	JF			
<b>OCTAVIA TOUR</b>							
(1U)  	96 » 11	545274G	545274	JF	155275G	155275	SC
<b>OCTAVIA 2</b>							
(1Z)  Tube Jambe de Force : Ø Externe = 50mm Strut Outer Tube : External Ø (OD) = 50mm Except GTi, (SS) Except 	06.04 » 12.12	545611G <sup>(2)</sup>	545611 <sup>(2)</sup>	JF	255613G <sup>(2)</sup>	255613 <sup>(2)</sup>	GC
(1Z)  Tube Jambe de Force : Ø Externe = 55mm Strut Outer Tube : External Ø (OD) = 55mm Except GTi, (SS) Except 	06.04 » 12.12	545612G <sup>(2)</sup>	545612 <sup>(2)</sup>	JF	255613G <sup>(2)</sup>	255613 <sup>(2)</sup>	GC
(1Z)  Tube Jambe de Force : Ø Externe = 50mm Strut Outer Tube : External Ø (OD) = 50mm Except GTi, (SS) Except 	01.05 » 12.12	545611G <sup>(2)</sup>	545611 <sup>(2)</sup>	JF	255613G <sup>(2)</sup>	255613 <sup>(2)</sup>	GC





MODELE MODEL	ANNEE / YEAR						
		AVANT / FRONT			ARRIÈRE / REAR		
		GAZ / GAS	HYD	TYPE	GAZ / GAS	HYD	TYPE
<b>OCTAVIA 2</b>							
(1Z)    Tube Jambe de Force : Ø Externe = 55mm Strut Outer Tube : External Ø (OD) = 55mm Except GTi, (SS) Except 	01.05 » 12.12	(2) 545612G	(2) 545612	JF	(2) 255613G	(2) 255613	GC
<b>OCTAVIA 3</b>							
(5E)     Tube Jambe de Force : Ø Externe = 50mm Strut Outer Tube : External Ø (OD) = 50mm Except  AR/Rear, (SS), RS Except 	01.13 »	545809G	545809	JF	255911G	255911	GC
(5E)     Tube Jambe de Force : Ø Externe = 55mm Strut Outer Tube : External Ø (OD) = 55mm Except  AR/Rear, (SS), RS Except 	01.13 »	545800G	545800	JF	255911G	255911	GC
(5E)     Tube Jambe de Force : Ø Externe = 50mm Strut Outer Tube : External Ø (OD) = 50mm (+)  AR/Rear Except (SS), RS Except 	01.13 »	545809G	545809	JF	255924G	255924	GC



MODELE MODEL	ANNEE / YEAR						
		AVANT / FRONT			ARRIÈRE / REAR		
		GAZ / GAS	HYD	TYPE	GAZ / GAS	HYD	TYPE
<b>OCTAVIA 3</b>							
(5E)  Tube Jambe de Force : Ø Externe = 55mm Strut Outer Tube : External Ø (OD) = 55mm (+)  AR/Rear Except  , RS Except 	01.13 »	544800G	545800	JF	255924G	255924	GC
<b>SKODA RAPID</b>							
<b>RAPID</b>							
	12 »	545751G	545751	JF	155934G	155934	SC
	13 »	545751G	545751	JF	155934G	155934	SC
<b>SKODA ROOMSTER</b>							
<b>ROOMSTER</b>							
(5J) 	06 »	545566G	545566	JF	155504G	155504	SC
<b>SKODA SUPERB</b>							
<b>SUPERB 1</b>							
(3U)  Except 	02 » 08.08	345667G	345667	SR	155373G	155373	SC
(3U)  (+) 	02 » 08.08	345680G	345680	SR			
<b>SUPERB 2</b>							
(3T4)  Except 	09.08 » 07.15	545612G	545612	JF	255613G	255613	GC
(3T5)  Except  , Off-Road	09 » 02.15	545612G	545612	JF	255613G	255613	GC
<b>SKODA YETI</b>							
<b>YETI</b>							
(5L) 	09 »	545611G	545611	JF	255793G	255793	GC





MODELE MODEL	ANNEE / YEAR						
		AVANT / FRONT			ARRIÈRE / REAR		
		GAZ / GAS	HYD	TYPE	GAZ / GAS	HYD	TYPE

## SSANGYONG

### SSANGYONG 4x4



#### ACTYON SPORT



 Q100	05 »	345981G	345981	SR	255982G	255982	GC
---	------	---------	--------	----	---------	--------	----

#### KORANDO

KJ	96 »	245112G	245112	GC	255554G	255554	GC
----	------	---------	--------	----	---------	--------	----

#### KYRON

 2.0 XDi, 2.7 XDi 	05 »	345981G	345981	SR	255982G	255982	GC
--	------	---------	--------	----	---------	--------	----

 2.0 XDi, 2.7 XDi 	05 »	345981G	345981	SR	255985G	255985	GC
--	------	---------	--------	----	---------	--------	----

#### MUSSO



 Except 	93 »	745658G	745658	PLL	255659G	255659	GC
---	------	---------	--------	-----	---------	--------	----

#### REXTON 1

 2.7 XDi, 2.9 TD, 3.2	02 » 06	345981G	345981	SR	255983G	255983	GC
---	---------	---------	--------	----	---------	--------	----

#### REXTON 2

 2.7 XDi, 2.9 TD, 3.2 	06 »	345984G	345984	SR	255982G	255982	GC
--	------	---------	--------	----	---------	--------	----

 2.7 XDi, 2.9 TD, 3.2 	06 »	345984G	345984	SR	255985G	255985	GC
--	------	---------	--------	----	---------	--------	----



## STEYR PUCH

#### HALFLINGER



HALFLINGER			101922	SC		101922	SC
------------	--	--	--------	----	--	--------	----

## SUBARU



#### LEONE

(AB, AF, AJ, AM, AW)    	80 » 08.84				<sup>(1)</sup> 114429G	<sup>(1)</sup> 114429	SC
--	------------	--	--	--	------------------------	-----------------------	----









MODELE MODEL	ANNEE / YEAR						
		AVANT / FRONT			ARRIÈRE / REAR		
		GAZ / GAS	HYD	TYPE	GAZ / GAS	HYD	TYPE













## SUNBEAM

ALPINE							
MK IV, V	64 » 68	141592G	141592	SC		151593	SC
Fastback	69 » 75	441998G	441998	FU	151999G	151999	SC
Talbot	75 »	144345G	144345	SC	154346G	154346	SC
AVENGER							
R2, R3 	70 » 08.74	444353G	444353	FU	154354G <sup>(1)</sup>	154354 <sup>(1)</sup>	SC
R4 	09.74 »	444685G	444685	FU	154354G <sup>(1)</sup>	154354 <sup>(1)</sup>	SC
R5 	78 »	444685G	444685	FU	154686G <sup>(1)</sup>	154686 <sup>(1)</sup>	SC
RAPIER							
Series IV, V	63 » 67	141561G	141561	SC	171159G	171159	SC
Rapier H120	68 » 76	441998G	441998	FU	151999G	151999	SC
STILETTO							
Imp Sport	68 » 76					151558	SC









## SUZUKI

IGNIS							
	00 »				115665G	115665	SC
JIMNY							
 LJ 10, 20, LJ 81K, 81P, SJ 10	70 » 77	145525G	145525	SC	104534G	104534	SC
 LJ 80, 80Q, 80V, SJ 10, 20	77 » 04.81	145525G	145525	SC	151477G	151477	SC
SN 413 (JA, JB) Ressorts Hélicoïdaux	98 » 12.05	145525G	145525	SC	115526G	115526	SC
1.3V VT, 1.5D DiS 	12.05 »	145525G	145525	SC	115526G	115526	SC
JIMNY / Samurai / Santana							
 SJ 30, 40, SJ 410, 413	05.81 » 87	145525G	145525	SC	104534G	104534	SC
 SJ 410, 413 	88 »	145525G	145525	SC	115118G	115118	SC















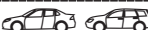

MODELE MODEL	ANNEE / YEAR						
		AVANT / FRONT			ARRIÈRE / REAR		
		GAZ / GAS	HYD	TYPE	GAZ / GAS	HYD	TYPE
<b>SPLASH</b>							
	07 »	545729G L 545720G R	545729 L 545720 R	JF	155715G	155715	SC
<b>SWIFT</b>							
(EZ, MZ)   RS 413, RS 415 Except Sport	03.05 » 08.10	545729G L 545720G R	545729 L 545720 R	JF	155715G	155715	SC
(FZ, NZ)  Except Sport	09.10 »				155925G	155925	SC
<b>SX4</b>							
 	06 »				155781G	155781	SC
<b>VITARA / Escudo / Santana / Sidekick</b>							
(ET, TA)  (2, 3 Portes/Doors) Court/SWB (-) ABS Made in JPN - SE 416 (JSAE, 2S3)	89 » 95	545206G	545206	JF	155259G	155259	SC
(ET, TA)  (2, 3 Portes/Doors) Court/SWB (+) ABS Made in ESP - SE 416 : JJ, JV, TV (VSE)	89 »				155259G	155259	SC
(ET, TA)  (2, 3 Portes/Doors) Court/SWB (+) ABS Made in JPN - SE 416 : (JSAE, 2S3)	96 »				155259G	155259	SC
(ET, TA)  (5 Portes/Doors) Long/LWB (-) ABS Made in JPN - SE 416 : TD (JSAE, 2S3)	89 » 95	545206G	545206	JF	155207G	155207	SC



MODELE MODEL	ANNEE / YEAR						
		AVANT / FRONT			ARRIÈRE / REAR		
		GAZ / GAS	HYD	TYPE	GAZ / GAS	HYD	TYPE
<b>VITARA / Escudo / Santana / Sidekick</b>							
(ET, TA)  (5 Portes/Doors) Long/LWB (+) ABS Made in ESP - SE 416 : TW (VSE)	89 »				155207G	155207	SC
(ET, TA)  (5 Portes/Doors) Long/LWB (+) ABS Made in JPN - SE 416 : TD (JSAE , 2S3)	96 »				155207G	155207	SC
(ET, TA)  (5 Portes/Doors) Long/LWB (+) ABS Made in JPN - SV 420 , 620 : TD (JSAE, 2S3)	94 »				155207G	155207	SC
<b>GRAND VITARA</b>							
(FT, GT) SQ 416/420/425 (JSAF, 2S2) Except XL6 , XL7	98 » 08.05				155259G	155259	SC
(FT, GT) SQ 416/420/425 (JSAF, 2S2) XL6, XL7	98 » 08.05				155686G	155686	SC
<b>WAGON R+</b>							
SR 410 (MA6), SR 420 (MA8, MB8)	97 » 02.00				115474G	115474	SC
RB 410 (MA5)	05.00 »	545896G L 545897G R	545896 L 545897 R	JF	115665G	115665	SC
<b>X90</b>							
(EL)  	95 »				155259G	155259	SC
<b>TALBOT France</b>							
<b>160 - 180</b>							
	70 » 75		441973	FU		251974	GC
<b>1100</b>							
 	76 »	141721G	141721	SC	151722G	151722	SC





MODELE MODEL	ANNEE / YEAR						
		AVANT / FRONT			ARRIÈRE / REAR		
		GAZ / GAS	HYD	TYPE	GAZ / GAS	HYD	TYPE
<b>1100 AS</b>							
 VF2:  504389 → VF3	76 »	(1) 144345G	(1) 144345	SC	154528G	154528	SC
<b>1200</b>							
	»	141721G	141721	SC	151722G	151722	SC
<b>1307 - 1308 - 1309</b>							
	74 »	144345G	144345	SC	154346G	154346	SC
<b>1510</b>							
	79 »	144345G	144345	SC	154346G	154346	SC
<b>1609 - 1610</b>							
2 litres	76 »		441973	FU		251974	GC
<b>AVENGER</b>							
	79 »	444353G	444353	FU	154354G	154354	SC
<b>BAGHEERA</b>							
	73 » 80		144287	SC		114288	SC
<b>HORIZON</b>							
	77 »	144548G	144548	SC	154346G	154346	SC
<b>MURENA</b>							
1.6, 2.2	80 »	145185G	145185	SC			
<b>RANCHO</b>							
	77 »	144345G <sup>(1)</sup>	144345 <sup>(1)</sup>	SC	154528G	154528	SC
<b>SAMBA</b>							
 Except Samba Rallye	82 »	544819G	544819	JF	354580G	354580	SR
RALLYE	82 »				354580G	354580	SR
<b>SOLARA</b>							
	79 »	144345G	144345	SC	154346G	154346	SC
<b>SUNBEAM</b>							
	79 »	444685G	444685	FU	154686G	154686	SC
<b>TAGORA</b>							
	80 » 85	444444G	444444	FU	254484G	254484	GC





## TALBOT U.K.

### TALBOT U.K. Utilitaires/Commerciaux

#### EXPRESS

	81 » 85	544960G	544960	JF	214809G	214809	GC
 Except 	<sup>(2)</sup> 86 » 94	544040G	544040	JF	214809G	214809	GC







MODELE MODEL	ANNEE / YEAR						
		AVANT / FRONT			ARRIÈRE / REAR		
		GAZ / GAS	HYD	TYPE	GAZ / GAS	HYD	TYPE
<b>EXPRESS</b>							
 (2)	86 » 94	544961G	544961		714968G	714968	PLL
	86 » 94	544040G	544040	JF	214963G	214963	GC









## TATA

<b>TELCOLINE</b>							
<b>TELCOLINE</b>							
			145177	SC		215178	GC
<b>TELCOSPORT</b>							
<b>TELCOSPORT</b>							
			145177	SC		215194	GC





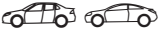

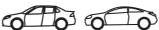



















## TOYOTA

<b>TOYOTA AURIS</b>							
<b>AURIS</b>							
NRE15, ZZE15, ADE15, ZRE15, NDE15 1.3, 1.4L, 1.6L, 1.8, 2.0L Except 2.2 L Diesel	10.06 »				755960G	755960	PLL
E15 Berline/Saloon 3/5 Portes  (Japon)	10.06 » .12				755960G	755960	PLL
<b>TOYOTA AYGO</b>							
<b>AYGO</b>							
	05 » 05.14	545696G L 545697G R	545696 L 545697 R	JF	155698G	155698	SC
	06.14 »				155698G	155698	SC
<b>TOYOTA CARINA I</b>							
<b>1400 --&gt; 2000</b>							
RA10, 30, TA10, 30, 40	70 » 07.77	444706G	444706	FU	154130G	154130	SC
<b>1500 --&gt; 2000</b>							
AA60, CA60, RA40, 60, SA60, TA 40, 60	08.77 » 09.83	444706G	444706	FU	154354G	154354	SC
<b>TOYOTA CARINA II / CORONA</b>							
<b>1600</b>							
(AT151) 	10.83 » 12.87	445173G	445173	FU			
<b>1500 &amp; 1600</b>							
(AT171) 	01.88 » 92	445173G	445173	FU			













MODELE MODEL	ANNEE / YEAR						
		AVANT / FRONT			ARRIÈRE / REAR		
		GAZ / GAS	HYD	TYPE	GAZ / GAS	HYD	TYPE
<b>TOYOTA CELICA</b>							
<b>1600 - 2000</b>							
1600 (TA 20, 22, 27) 2000 (RA 21, 25, 27)	70 » 09.75		441009	FU	154130G	154130	SC
1600 (TA 23, 28, 35) 2000 (RA 22, 23, 24, 28, 29, 35)	10.75 » 07.77	444706G	444706	FU	154130G	154130	SC
<b>1600 - 1800 - 2000</b>							
(RA40, TA40) Roues/Weels = 13	08.77 » 07.80	444706G	444706	FU	154354G	154354	SC
(MA40, RA40, TA40) Roues/Weels = 14	08.77 » 07.80	444404G	444404	FU	154354G	154354	SC
<b>1600 --&gt; 2800</b>							
(MA50, RA50, 60, TA50, 60)	08.80 » 07.81	444404G	444404	FU	254967G	254967	GC
<b>1600</b>							
(TA60) 	08.81 » 07.85	444706G	444706	FU	154354G	154354	SC
(AA63) 	08.81 » 07.85	444404G	444404	FU	254967G	254967	GC
<b>2000</b>							
(RA60, ST60, XT60) 	08.81 » 07.85	444404G	444404	FU	154354G	154354	SC
(RA61, RA63, RA65, SA63) 	08.81 » 07.85	444404G	444404	FU	254967G	254967	GC
<b>2800</b>							
Supra SPR (MA61)	81 » 05.83	444966G	444966	FU	254967G	254967	GC
Supra SPR (MA61)	06.83 » 86	444706G	444706	FU	254967G	254967	GC
<b>TOYOTA COASTER</b>							
<b>COASTER</b>							
Series: BU19, RU19	72 » 07.77	204552G	204552	GC	204587G	204587	GC
Series: BB10, 11, RB10, 11, 12, 13	08.77 » 04.82				204587G	204587	GC
<b>TOYOTA COROLLA --&gt; 04.83</b>							
<b>1100 &amp; 1200</b>							
(KE10, 11, 15, 16, 17) 	67 » 05.70		441704	FU		151804	SC
(KE16, 18) 	67 » 05.70		441704	FU			
<b>1200</b>							
(KE20, 25, TE 20, 25) 	06.70 » 07.74		444317	FU		154334	SC

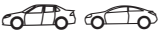
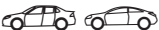





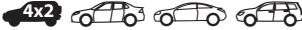
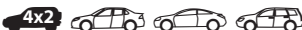







MODELE MODEL	ANNEE / YEAR						
		AVANT / FRONT			ARRIÈRE / REAR		
		GAZ / GAS	HYD	TYPE	GAZ / GAS	HYD	TYPE
<b>1200</b>							
(KE26V) 	06.70 » 07.74		444317	FU			
(KE30, 35, 40, 45, 50, 55, 60, 65)  	08.74 » 81		444317	FU	151762G	151762	SC
(KE36V) 	08.74 » 81		444317	FU	154612G	154612	SC
<b>1300</b>							
(KE55)  	78 » 81		444317	FU	154354G	154354	SC
(KE70)  	79 » 04.83		444845	FU	154130G	154130	SC
(KE70, 71, 72, 73) 	79 » 04.83		444845	FU	154354G	154354	SC
<b>1400</b>							
(TE25)  	70 » 07.74		444317	FU	154334G	154334	SC
(TE30, 40)  	08.74 » 79	444404G	444404	FU	151762G	151762	SC
(TE36V) 	70 » 79	444404G	444404	FU	154612G	154612	SC
<b>1500</b>							
(AE70)  	79 » 04.83		444845	FU	154130G	154130	SC
<b>1600</b>							
(TE31, 37, 51, 52, 55, 61, 62, 65, 66)  	75 » 80	444404G	444404	FU	151762G	151762	SC
(TE70, 71)  	79 » 04.83	444404G	444404	FU	154130G	154130	SC
(CE70)   Diesel	79 » 04.83	444404G	444404	FU	154130G	154130	SC
(TE27)  Sprinter Trueno	71 » 07.74	444706G	444706	FU	154334G	154334	SC
(TE47)  Sprinter Trueno	08.74 » 79	444404G	444404	FU			







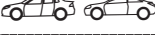





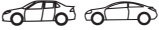

MODELE MODEL	ANNEE / YEAR						
		AVANT / FRONT			ARRIÈRE / REAR		
		GAZ / GAS	HYD	TYPE	GAZ / GAS	HYD	TYPE
<b>1600</b>							
(AE71, TE71, TE 73) 	79 » 04.83	444404G	444404	FU	154354G	154354	SC
<b>1800</b>							
(TE72) 	79 » 04.83	444404G	444404	FU	154130G	154130	SC
(CE 70)  Diesel	79 » 04.83	444404G	444404	FU	154130G	154130	SC
(CE 70)  Diesel	79 » 04.83	444404G	444404	FU	154354G	154354	SC
<b>TOYOTA COROLLA 05.83 --&gt; 05.92</b>							
<b>1300 - 1500 - 1600</b>							
1300 (AE80), 1500 (EE80), 1600 (AE82)  Except 1600 GT	05.83 » 05.87	445173G	445173	FU			
<b>1600</b>							
(AE71) 	05.83 » 84		444845	FU	154130G	154130	SC
(AE86)  Trueno/GTi, TwinCam 16V Propulsion/ RWD	05.83 » 05.87	444404G	444404	FU	154130G	154130	SC
<b>1300 - 1600 - 1800 D</b>							
1300 (KE70, 71), 1600 (AE71, TE 71, 73), 1800 Diesel (CE 70) 	05.83 » 05.92	444404G	444404	FU	154354G	154354	SC
<b>1300 - 1600</b>							
1300 (EE90), 1600 (AE92, EE 92)  Except GTi	06.87 » 05.92	444090G	444090	FU			
<b>1600 - 1800 D</b>							
1600 GTi (AE92), 1800 Diesel (CE90, 92) 	06.87 » 05.92		445228	FU			
<b>TOYOTA COROLLA 01.02 --&gt;</b>							
<b>COROLLA</b>							
(ZZE12, NDE12, ZDE12)  (GB)	01.02 » 07	545964G L 545965G R	545964 L 545965 R	JF	355966G	355966	SR

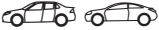
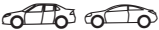

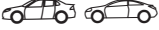









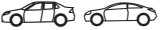

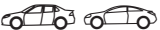
MODELE MODEL	ANNEE / YEAR						
		AVANT / FRONT			ARRIÈRE / REAR		
		GAZ / GAS	HYD	TYPE	GAZ / GAS	HYD	TYPE
<b>COROLLA</b>							
(ZZE12, NDE12, ZDE12)  Japon	09.02 » 08	545964G L 545965G R	545964 L 545965 R	JF	355966G	355966	SR
(ZZE12- CDE12)  Exept <b>A</b> Japon	10.01 » .07				355966G	355966	SR
(ZZE14, CE140, NZE141)  AXION LX, XLi Japon	07.07 » 13	545967G L 545968G R	545967 L 545968 R	JF	355969G	355969	SR
(ZZE14, CE140, NZE141)  LX, XLi Japon	07.08 » 13	545967G L 545968G R	545967 L 545968 R	JF	355969G	355969	SR
E15  Japon	10.07 »				755960G	755960	PLL
<b>COROLLA AXIO</b>							
NRE15, ZZE15, ADE15, ZRE15, NDE15 1.3, 1.6 1.3 VVTi, 1.4 VVTi, 1.6 VVTi 1.4 D4, 2.0 D4D	10.06 »				755960G	755960	PLL
(ZZE14, CCE14, NZE14)  Japon	04.07 » 13	545967G L 545968GR	545967 L 545968 R	JF	355969G	355969	SR
(ZZE14, CCE14, NZE14)  Japon	04.07 » 13	545967G L 545968G R	545967 L 545968 R	JF	355969G	355969	SR
<b>COROLLA VERSO</b>							
(ZNR10, ZNR11, CUR10, AUR10) 	02.04 »				755960G	755960	SR
<b>1500 --&gt; 2000</b>							
Series : RT 40, 50, 60, 70, 80, 90 	64 » 07.73	141761G	141761	SC	151762G	151762	SC
<b>1500 --&gt; 1900</b>							
Series : RT 40 	65 » 70	141761G	141761	SC	114535G	114535	SC
Series : PT 40 	64 » 07.73	141761G	141761	SC	114535G	114535	SC

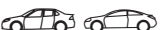

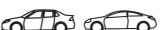

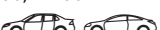







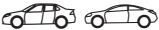

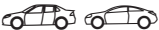
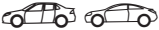

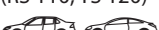
MODELE MODEL	ANNEE / YEAR						
		AVANT / FRONT			ARRIÈRE / REAR		
		GAZ / GAS	HYD	TYPE	GAZ / GAS	HYD	TYPE
<b>1500 --&gt; 1700</b>							
Series : RT 80 	70 » 07.73	141761G	141761	SC			
<b>1600 --&gt; 2000</b>							
Series : RT 100, 110, 120, TT 100, 110, 120 	08.73 » 08.78	141761G	141761	SC	154130G	154130	SC
Series : RT 140, TT 140  ⑭	01.82 » 87	444588G	444588	FU	154589G	154589	SC
<b>1601 --&gt; 2000</b>							
Series : RT 100, 110, TT 100, 110 	08.73 » 08.78	141761G	141761	SC	204587G	204587	GC
<b>1602 --&gt; 2000</b>							
Series : RT 130, TT 130, XT 130  ⑬	09.78 » 12.81	444706G	444706	FU	154354G	154354	SC
<b>1603 --&gt; 2000</b>							
Series : RT 130, TT 130, XT 130  ⑭	09.78 » 12.81	444588G	444588	FU	154354G	154354	SC
<b>1604 --&gt; 2000</b>							
Series : RT 130, TT 130, XT 130 	09.78 » 12.81	444706G	444706	FU	151762G	151762	SC
<b>1500 --&gt; 1800</b>							
Series : CT 140, RT 140, ST 140  ⑬	01.82 » 87	444706G	444706	FU	154354G	154354	SC
<b>1600 --&gt; 1800</b>							
Series : CT 140, TT 140 	01.82 » 87	444706G	444706	FU	151762G	151762	SC
<b>TOYOTA : COROLLA VERSO</b>							
<b>VERSO 1 E12</b>							
 (Grand Bretagne)	09.01 » 12.03				355966G	355966	SR
<b>VERSO 2 E12</b>							
 (Grand Bretagne)	02.04 »				355971G	355971	SR





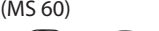
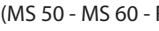





MODELE MODEL	ANNEE / YEAR						
		AVANT / FRONT			ARRIÈRE / REAR		
		GAZ / GAS	HYD	TYPE	GAZ / GAS	HYD	TYPE
<b>TOYOTA CORONA MK II</b>							
<b>1500 --&gt; 1900</b>							
Series : RT 60, 70 	68 » 12.71	141761G	141761	SC	114535G	114535	SC
<b>1501 --&gt; 1900</b>							
Series : PT 60, 70 , RT 60, 70 	68 » 12.71	141761G	141761	SC	114535G	114535	SC
<b>1800 --&gt; 2600</b>							
Series : MX 10, 20 , , RX 10, 20 	01.72 » 78	141761G	141761	SC	254433G	254433	GC
<b>1800 --&gt; 2300</b>							
Series : M10, R10 	01.72 » 78	141761G	141761	SC			
<b>1801 --&gt; 2300</b>							
Series : M20, R20 	01.72 » 78	141761G	141761	SC	204587G	204587	GC
<b>TOYOTA CRESSIDA</b>							
<b>1800 --&gt; 2600</b>							
Series : MX 30, 40 , RX 30, 40 , TX 30, 40 	77 » 08.80		444588	FU	154589G	154589	SC
<b>1801 --&gt; 2600</b>							
Series : MX 30, 40 , RX 30, 40 , TX 30, 40 	77 » 08.80		444588	FU	151762G	151762	SC
<b>1800 --&gt; 2800</b>							
Series : GX 60, LX 60, MX 60, RX 60, TX 60 	09.80 » 08.82	444966G	444966	FU	154589G	154589	SC
<b>1801 --&gt; 2800</b>							
Series : GX 60, LX 60, MX 60, RX 60, TX 60 	09.80 » 08.82	444966G	444966	FU	154354G	154354	SC
<b>1802 --&gt; 2800</b>							
Series : GX 60, LX 60, MX 60, RX 60, SX 60, TX 60 	09.82 » 07.84	444966G	444966	FU	154589G	154589	SC
<b>1803 --&gt; 2800</b>							
Series : GX 60 , LX 60 , MX 60 , RX 60 , SX 60, TX 60 	09.82 » 07.84	444966G	444966	FU	154354G	154354	SC

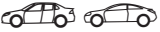
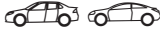
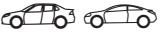

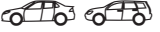







MODELE MODEL	ANNEE / YEAR						
		AVANT / FRONT			ARRIÈRE / REAR		
		GAZ / GAS	HYD	TYPE	GAZ / GAS	HYD	TYPE
<b>2000 --&gt; 2800</b>							
Series : GX 70 , LX 70 , MX 70, SX 70, YX 70 	08.84 » 08.88	444966G	444966	FU	154589G	154589	SC
<b>2001 --&gt; 2800</b>							
Series : GX 70, LX 70, MX 70, YX 70 	08.84 » 08.88	444966G	444966	FU	154354G	154354	SC
<b>TOYOTA CROWN</b>							
<b>1900</b>							
(RS 40) 	65 » 67		241763	GC	141525G	141525	SC
<b>2000</b>							
(MS 40) 	65 » 08.67		241763	GC	141525G	141525	SC
(RS 50, RS 60) 	09.67 » 08.67		244683	GC		111955	SC
(RS 80) 	10.74 » 08.79		244683	GC		214218	GC
(RS 110, YS 120) 	09.79 » 87		244683	GC		254433	GC
(MS 40) 	65 » 08.67		241763	GC	211765G	211765	GC
(MS 50 → 80 - RS 50 , 60) 	09.67 » 87		244683	GC	211765G	211765	GC
<b>2200</b>							
(LS 110) 	79 » 87		244683	GC		254433	GC
<b>2300</b>							
(MS 40) 	65 » 08.67		241763	GC	141525G	141525	SC
(MS 50) 	09.67 »		244683	GC		111955	SC
(MS 60) 	02.71 » 87		244683	GC		214218	GC
(MS 50 - MS 60 - RS 50) 	67 » 87		244683	GC	211765G	211765	GC
<b>2400</b>							
(GS 110) 	79 » 87		244683	GC		254433	GC

















MODELE MODEL	ANNEE / YEAR						
		AVANT / FRONT			ARRIÈRE / REAR		
		GAZ / GAS	HYD	TYPE	GAZ / GAS	HYD	TYPE
<b>2500</b>							
(LS 120) 	83 » 87		244683	GC		254433	GC
<b>2600</b>							
(MS 60 - MS 70 - MS 80 - MS 90 - MS 100) - 	71 » 08.79		244683	GC		214218	GC
(MS 110) 	09.79 »		244683	GC		254433	GC
(MS 60 - MS 80) 	71 » 08.79		244683	GC	211765G	211765	GC
(MS 110) 	09.79 » 87		244683	GC		254433	GC
<b>2800</b>							
(MS 110, 120)  	79 » 87		244683	GC		254433	GC
<b>TOYOTA DYNA</b>							
<b>200 --&gt; 400</b>							
(BU10, 10H, 12, 15, 15H)	69 » 07.77	204552G	204552	GC	204587G	204587	GC
(JU10, 10H, 12, 15, 15H)	69 » 07.77	204552G	204552	GC	204587G	204587	GC
(RU10, 10H, 12, 15, 15H)	72 » 07.77	204552G	204552	GC	204587G	204587	GC
(HU15H)	69 » 07.77				204587G	204587	GC
(BU20, 30, 35, 36)	08.77 » 84	244861G	244861	GC	204587G	204587	GC
(HU30, 50, JU20, RU20,30)	08.77 » 84	244861G	244861	GC	204587G	204587	GC
<b>LH - YH</b>							
LH 80 (2.4 D) YH 81 (1.8)  (100)	85 » 04.95	244088G	244088	GC			
<b>LY</b>							
100 (2.4 D) (100)	05.95 »	244088G	244088	GC			
<b>TOYOTA FOUR - RUNNER</b>							
<b>FOUR - RUNNER</b>							
 (1) RN61	87 »	744075G	744075	PLL	714077G	714077	PLL
 (1) KZN130, LN130, VZN130, YN130 LND9, VND0	89 »	744075G	744075	PLL	754078G	754078	PLL











MODELE MODEL	ANNEE / YEAR						
		AVANT / FRONT			ARRIÈRE / REAR		
		GAZ / GAS	HYD	TYPE	GAZ / GAS	HYD	TYPE
<b>TOYOTA HI - ACE</b>							
<b>HI - ACE</b>							
HI - ACE 1 LH 10, 20, 30, 40, PH 10, RH 10, 20 Except RH 22, 24, 30, 40	67 » 11.82	244586G	244586	GC	204587G	204587	GC
HI - ACE 2 RH22	77 » 11.82	244586G	244586	GC			
HI - ACE 3 LH 50, 60, 70, YH 50, 60, 70	12.82 » 12.83		245167	GC		215176	GC
HI - ACE 3  LH 51, 61, 71, YH 50, 51, 60, 61, 71	01.84 » 08.89		245167	GC		215168	GC
HI - ACE 3  LH 56, 66, YH 56, 66	86 » 08.89				215031G	215031	GC
HI - ACE 3 LH 80, YH 81  Dyna 100	85 »	244088G	244088	GC			
HI - ACE 4  LH 102/112 - RZH 102/103/112/113/115	08.89 » 07.95	245027G	245027	GC			
HI - ACE 4  LH 108/118 - RZH 109/119	09.89 » 07.95	245025G	245025	GC	215028G	215028	GC
HI - ACE 4  LH 107G/117G	08.89 » 08.95	245025G	245025	GC	215028G	215028	GC
HI - ACE 4  LH 166/176	08.98 »	245025G	245025	GC	215028G	215028	GC
HI - ACE 4  LXH 12/22 - RCH 12/13/22/23	08.95 » 07.99	245027G	245027	GC	235029G	235029	GC
HI - ACE 4  LXH 18/28 - RCH 18/19/28/29	08.95 »	245025G	245025	GC	235026G	235026	GC

















MODELE MODEL	ANNEE / YEAR						
		AVANT / FRONT			ARRIÈRE / REAR		
		GAZ / GAS	HYD	TYPE	GAZ / GAS	HYD	TYPE
<b>HI - ACE</b>							
HI - ACE 5  KDH2, LH2, TRH2	01.05 »	245027G	245027	GC	215028G	215028	GC
HI - ACE 5  2.5 D - 4D	01.05 »	245027G	245027	GC	235026G	235026	GC
<b>TOYOTA HI - LUX</b>							
<b>HI - LUX</b>							
HI - LUX 1-2  RN 10, 13, 15, 16, 20, 22, 25, 27, 28	67 » 07.78	244586G	244586	GC	204587G	204587	GC
HI - LUX 3  RN 30, 31, 32, 33, 34, 35, 40, 41, 42, 44	08.78 » 84	244586G	244586	GC	204587G	204587	GC
HI - LUX 3  LN 30, 40	78 » 84	244586G	244586	GC	204587G	204587	GC
HI - LUX 3  LN 36, 46, RN 36, 39, 46	79 » 07.83	144472G	144472	SC		114473	SC
HI - LUX 4  LN 50, 51, 55, 56, RN 50, 55, YN 50, 51, 52, 55, 56, 57, 58	08.83 » 07.88	244586G	244586	GC	211765G	211765	GC
HI - LUX 4  LN50,51,55,56,YN51,56	08.84 » 08.89	148671G	148671	SC	118672G	118672	SC
HI - LUX 4  LN 60, 61, 65, YN 60, 61, 62, 65, 67	08.83 » 07.88	144472G	144472	SC			
HI - LUX 5  LN 85, 90, YN 85, 90	08.88 » 07.97	144472G	144472	SC			
HI - LUX 5  LN 105, YN 106	08.88 » 07.97	744073G	744073	PLL	214074G	214074	GC
HI - LUX 5  LN 108, 110, RN 106, 108, 110, YN 110	08.88 » 07.97	744075G	744075	PLL	214076G	214076	GC













MODELE MODEL	ANNEE / YEAR						
		AVANT / FRONT			ARRIÈRE / REAR		
		GAZ / GAS	HYD	TYPE	GAZ / GAS	HYD	TYPE
<b>HI - LUX</b>							
HI - LUX 6 Ph 1-2 LN 145, 150	08.97 » 07.01	144472G	144472	SC			
HI - LUX 6 Ph 1-2 LN 165, 170, RZN 168, 173	08.97 » 07.01	744075G	744075	PLL			
HI - LUX 6 Ph 1-2 LN A4, A7, B8  Avant	90 » 07.01	744075G	744075	PLL	214074G	214074	GC
HI - LUX 6 Ph 1-2 LN A4, A7, B8  Avant/Front	90 » 07.01	744073G	744073	PLL	214074G	214074	GC
HI - LUX 6 Ph 1-2 KDN 145, 150	08.01 »	144472G	144472	SC			
HI - LUX 6 Vigo  4x2 KUN 15, 16	08.04 »	545935 L 545936 R	545935 L 545936 R	SR	215937G	215937	GC
HI - LUX 6 Vigo  4x4 KUN 25	04 »	349331G	349331	SR	215020G	215020	GC
<b>TOYOTA LAND CRUISER 4x4</b>							
<b>LAND CRUISER</b>							
BJ 40, 42, 43, 45, 46 - FJ 40, 42, 43, 45 - HJ 45, 47	69 » 86	204552G	204552	GC	211765G	211765	GC
BJ 55 - FJ 55, 56	69 » 80	244894G	244894	GC	211765G	211765	GC
HZJ 70, 73, PZJ 70, 73 	90 »	744066G	744066	PLL	714067G	714067	PLL
HZJ 75 - PZJ 75 	90 »	744003G	744003	PLL	714004G	714004	PLL
LJ 70, 73, 77, 79 - RJ 70, 73 - KZJ 70, 73, 77	90 »	744068G	744068	PLL	734069G	734069	PLL
FJ 80, FZJ 80, HDJ 80, HZJ 80 	90 »	764060G	764060	PL	854071G	854071	PL
GJ 90, KZJ 90, VZJ 90	96 » 09.02				755574G <sup>(3)</sup>	755574 <sup>(3)</sup>	PLL
GJ 95, KZJ 95, VZJ 95	96 » 09.02				755574G <sup>(3)</sup>	755574 <sup>(3)</sup>	PLL
HDJ100, KZJ100, UZJ100	98 »				855516G <sup>(3)</sup>	855516 <sup>(3)</sup>	PL
<b>TOYOTA LITE - ACE</b>							
<b>LITE - ACE</b>							
KM10, 11	70 » 09.79	141761G	141761	SC	114535G	114535	SC













MODELE MODEL	ANNEE / YEAR						
		AVANT / FRONT			ARRIÈRE / REAR		
		GAZ / GAS	HYD	TYPE	GAZ / GAS	HYD	TYPE
<b>LITE - ACE</b>							
CM 20, KM 20  AR/Rear	10.79 » 09.85	144756G	144756	SC	214757G	214757	GC
CM 20, KM 20  AR/Rear	10.79 » 09.85	144756G	144756	SC	204587G	204587	GC
CM 35, 36, KM 36 	10.85 » 91				115364G	115364	SC
CR 27, KR 27, YR 29 	92 »				204587G	204587	GC
KM 67	92 »				204587G	204587	GC
<b>TOYOTA PASEO</b>							
<b>1500</b>							
(EL54)	95 »				355283G	355283	SR
<b>TOYOTA PUBLICA - OSAKA</b>							
<b>1000 &amp; 1200</b>							
(KP30) 	69 » 71					114487	SC
(KP30, 40, 45, 50) 	72 » 78	444428		FU	114536G	114536	SC
(KP 36 - KP 37) 	69 » 81	444428		FU			
<b>TOYOTA RAV 4 - FUN CRUISER 4x4</b>							
<b>RAV 4 I</b>							
 SXA 10 Except Pneus/Tyres 235/60R16	94 » 12.97	445202G	<sup>(2)</sup> 445202	FU	155203G	155203	GC
 SXA 10 (+) Pneus/Tyres 235/60R16	94 » 12.97	545654G L 545655G R	545654 L 545655 R	JF	155313G	155313	SC
 SXA 11 Except Pneus/Tyres 235/60R16	01.98 » 04.00	545654G L 545655G R	545654 L 545655 R	JF	155203G	155203	GC
<b>RAV 4 II</b>							
 ACA 20/21, CLA 20/21, ZCA 25/26	05.00 » 12.05	545688G L 545689G R	545688 L 545689 R	JF	155203G	155203	GC
<b>RAV 4 III</b>							
 ACA30 2.0 VVT-i, 2.2 D-4D	06 »	545975G L 545976G R	545975 L 545976 R	JF	215977G	215977	GC









MODELE MODEL	ANNEE / YEAR						
		AVANT / FRONT			ARRIÈRE / REAR		
		GAZ / GAS	HYD	TYPE	GAZ / GAS	HYD	TYPE
<b>TOYOTA STARLET</b>							
<b>1000 - 1200 - 1300</b>							
 1000 (KP 60) , 1200 (KP 62), 1300 (KP 61)	78 » 84	444663G	444663	FU	154664G	154664	SC
<b>1001 - 1200 - 1300</b>							
 1000 (KP 60 V), 1200 (KP 62 V), 1300 (KP 61 V)	78 » 84	444663G	444663	FU	154354G	154354	SC
<b>1002 - 1300 - 1500</b>							
1000 (EP 80), 1300(EP 81 , EP 82), 1500 (NP 80)	05.94 » 95				355283G	355283	SR
<b>1300</b>							
1300 (EP 91)	96 »	545454G L 545455G R	545454 L 545455 R	JF	355283G	355283	SR
<b>TOYOTA STOUT</b>							
<b>STOUT</b>							
40, 40V, 43	63 » 69	141761G	141761	SC	114535G	114535	SC
45, 47, 100, 101	60 » 79				114535G	114535	SC
110, 111	79 »				204587G	204587	GC
<b>TOYOTA SUPRA - SOARER</b>							
<b>2800</b>							
SUPRA SPR (MA61)	81 » 05.83	444966G	444966	FU	254967G	254967	GC
SUPRA SPR (MA 61)	06.83 » 86	444706G	444706	FU	254967G	254967	GC
<b>TOYOTA TERCEL</b>							
<b>1300</b>							
 1300 (AL 10)	78 » 04.82					154859	SC
<b>1300 - 1450</b>							
 1300 (AL 11), 1450 (AL 12)	78 » 04.82					154859	SC
<b>1450</b>							
 1450 (AL 25)	82 » 89	444975		FU	154130G	154130	SC
<b>TOYOTA VIOS</b>							
<b>VIOS</b>							
 Sedan	13 »	545903G	545903	JF	155904G	155904	SC



MODELE MODEL	ANNEE / YEAR						
		AVANT / FRONT			ARRIÈRE / REAR		
		GAZ / GAS	HYD	TYPE	GAZ / GAS	HYD	TYPE
<b>TOYOTA YARIS - YARIS VERSO</b>							
<b>YARIS I</b>							
1.0 (VVTi 70 inclus), 1.3 (VVTi 85 inclus° 1.4 D (D4D 75 inclus) Except Verso	99 » 01.06	545521G	545521	JF	155523G	155523	SC
1.5 TS (VVTi 105 inclus) Except Verso	99 » 01.06	545522G	545522	JF	155687G	155687	SC
<b>YARIS II</b>							
 Except Verso	02.06 » 08.11	545766G L 545767G R	545766 L 545767 R	JF	155768G	155768	SC
<b>YARIS III</b>							
 Except Verso	09.11 »	545766G L 545767G R	545766 L 545767 R	JF	155944G 155768G	155944 155768	SC
<b>YARIS III XP150</b>							
	13 »	545903G	545903	JF	155904G	155904	SC
<b>YARIS VERSO</b>							
	99 »	545522G	545522	JF	155524G	155524	SC
<b>TRABANT</b>							
<b>601</b>							
	65 » 91		144034	SC		144034	
<b>TRIUMPH</b>							
<b>1300</b>							
	65 » 70					151661	SC
<b>2000</b>							
	63 » 10.69		441784	FU		171619	SC
<b>2500</b>							
P.I.	63 » 10.69		441784	FU		171619	SC
2500, 2500 TC, MK II	11.69 » 77		441784	FU		171619	SC
<b>BRITT</b>							
	59 » 71					111342	SC
<b>GT6</b>							
MK I	66 » 68					111342	SC
<b>GT7</b>							
MK II	69 » 73					111868	SC
<b>GT8</b>							
MK III	74 » 80					111342	SC



TRIUMPH

MODELE MODEL	ANNEE / YEAR						
		AVANT / FRONT			ARRIÈRE / REAR		
		GAZ / GAS	HYD	TYPE	GAZ / GAS	HYD	TYPE
<b>HERALD</b>							
	59 » 71					111342	SC
<b>SPITFIRE</b>							
 MK I, II, III, IV	62 » 82					111342	SC
<b>STAG</b>							
Sport GT	70 » 77		441784	FU		171619	SC
<b>TR4 - TR5 - TR6 - TR250</b>							
TR4 A - TR5 - TR6 P - TR250	64 » 75		141615	SC			
<b>TR7 - TR8</b>							
TR7 - TR8	75 » 83		444677	FU		174678	SC
<b>VITESSE 2</b>							
	62 » 68		341341	SR		111342	SC
	69 » 72		341341	SR			









UMM

## UMM

































<b>UMM 4x4</b>								
<b>ALTER I</b>								
 ALTER I, ENTREPRENEUR	78 » 87					115364G	115364	SC
<b>ALTER II</b>								
B11 (100 H, S) - B13 (121 S)	87 »	205355G	205355	GC	215356G	215356	GC	

VAUXHALL























## VAUXHALL

<b>VAUXHALL ASTRA</b>							
<b>ASTRA</b>							
 (F) → J2791967, J5273427	79 » 07.88	444640G	444640	FU	154651G	154651	SC
 (F) J2791968, J5273428 →	08.88 » 08.91	444640G	444640	FU	155149G	155149	SC
 (Except Astra Max)	79 » 08.91	444640G	444640	FU	134652G	134652	SC
 Except GSi	09.91 » 97	445156G	445156	FU	155149G	155149	SC
 GSi  GSi	09.91 » 97	445157G	445157	FU	155158G	155158	SC
	09.91 » 97	445156G	445156	FU	134652G <sup>(1)</sup>	134652 <sup>(1)</sup>	SC
 AstraVan Except Astra Max	09.91 » 97	445156G	445156	FU	134652G <sup>(1)</sup>	134652 <sup>(1)</sup>	SC

















MODELE MODEL	ANNEE / YEAR						
		AVANT / FRONT			ARRIÈRE / REAR		
		GAZ / GAS	HYD	TYPE	GAZ / GAS	HYD	TYPE
<b>ASTRA</b>							
MAX 	85 » 97	444640G	444640	FU	114050G	114050	SC
<b>VAUXHALL BELMONT</b>							
<b>BELMONT</b>							
  → J2791967, J5273427	86 » 88	444640G	444640	FU	154651G	154651	SC
  J2791968, J5273428 →	88 » 91	444640G	444640	FU	155149G	155149	SC
<b>VAUXHALL CALIBRA</b>							
<b>CALIBRA</b>							
2.0 i <sup>(2)</sup>  Except 16V	90 »	444056G	444056	FU	155181G <sup>(1)</sup>	155181 <sup>(1)</sup>	SC
2.0i 16 V, 2.5 V6 <sup>(2)</sup> Except Turbo	90 »	445272G	445272	FU	255273G	255273	GC
<b>VAUXHALL CARLTON</b>							
<b>CARLTON</b>							
 	78 » 09.86	444666G	444666	FU	154327G	154327	SC
 	78 » 09.86	444666G	444666	FU	254328G	254328	GC
 <sup>(2)</sup>	10.86 » 04.94				155131G	155131	SC
 <sup>(2)</sup>	10.86 » 04.94				155120G	155120	SC
<b>VAUXHALL CAVALIER</b>							
<b>CAVALIER</b>							
	75 » 08.81	144385G	144385	SC	154489G	154489	SC
   → F1003026, F5000000, F6000000	09.81 » 08.84	444803G	444803	FU	154651G	154651	SC
   F1003027, F5000001, F6000001 →	09.84 » 07.88	444950G	444950	FU	154651G	154651	SC
   Except 2.0 16V, 2.5 V6	08.88 » 09.95	444056G	444056	FU	155149G <sup>(1)</sup>	155149 <sup>(1)</sup>	SC
   2.0 16V  N...	08.88 » 92	445272G	445272	FU	155131G <sup>(1)</sup>	155131 <sup>(1)</sup>	SC
   2.0 16V:  P...	93 » 09.95	445272G	445272	FU	155149G <sup>(1)</sup>	155149 <sup>(1)</sup>	SC













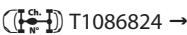

MODELE MODEL	ANNEE / YEAR						
		AVANT / FRONT			ARRIÈRE / REAR		
		GAZ / GAS	HYD	TYPE	GAZ / GAS	HYD	TYPE
<b>CAVALIER</b>							
   2.5 V6	08.88 » 09.95	445272G	445272	FU	<sup>(1)</sup> 155149G	<sup>(1)</sup> 155149	SC
   Except Turbo	08.88 » 09.95	445272G	445272	FU	<sup>(1)</sup> 155131G	<sup>(1)</sup> 155131	SC
 (F, D) → F1003026, F5000000, F6000000	83 » 08.84	444803G	444803	FU	115125G	115125	SC
 (F, D) F1003027, F5000001, F6000001 →	09.84 » 88	444950G	444950	FU	115125G	115125	SC
<b>VAUXHALL CHEVETTE</b>							
<b>CHEVETTE</b>							
   Except Hatchback	75 » 84	<sup>(3)</sup> 144385G	<sup>(3)</sup> 144385	SC	154327G	154327	SC
 Hatchback	75 » 84	<sup>(3)</sup> 144385G	<sup>(3)</sup> 144385	SC	141706G	141706	SC
  →	75 » 84	<sup>(3)</sup> 144385G	<sup>(3)</sup> 144385	SC	141706G	141706	SC
<b>VAUXHALL COMBO</b>							
<b>COMBO</b>							
 Base/Basis = Corsa B	94 » 01	545179G	545179	JF	114050G	114050	SC
<b>VAUXHALL CORSA</b>							
<b>CORSA</b>							
 1.0, 1.2	93 » 09.00	545179G	545179	JF	154935G	154935	SC
 1.3, 1.4, 1.5 (D, TD), 1.6 (GSi), 1.7 (D, TD)	93 » 09.00	545179G	545179	JF	254995G	254995	GC
 Combo	94 » 01	545179G	545179	JF			
 Corsavan	83 » 00	545179G	545179	JF	254995G	254995	GC
<b>VAUXHALL FIRENZA</b>							
<b>FIRENZA</b>							
1250 - 1750 	72 » 73	101871G	101871	SC	151872G	151872	SC
2300 	72 » 75	101871G	101871	SC	151872G	151872	SC















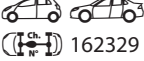





MODELE MODEL	ANNEE / YEAR						
		AVANT / FRONT			ARRIÈRE / REAR		
		GAZ / GAS	HYD	TYPE	GAZ / GAS	HYD	TYPE
<b>VAUXHALL FRONTERA 4x4</b>							
<b>FRONTERA</b>							
MK I (52 - 53 - 5J) Ressorts à lames	91 » 09.95	745319G	745319	PLL	215321G	215321	GC
MK I (54 - 55 - 5B - 5K - 5U) 	10.95 » 98	745310G	745310	PLL	715496G	715496	PLL
<b>MAGNUM</b>							
<b>MAGNUM</b>							
	73 » 78	101871G	101871	SC	151872G	151872	SC
<b>VAUXHALL MONTEREY 4x4</b>							
<b>MONTEREY</b>							
	92 » 03.95	745319G	745319	PLL	215322G	215322	GC
	04.95 »	745310G	745310	PLL	215322G	215322	GC
<b>VAUXHALL NOVA</b>							
<b>NOVA</b>							
MK I  Except GLS, GSi, GT, GTE, GTR, SR, Sport	83 » 93	545179G	545179	JF	154935G	154935	SC
MK I GLS, GSi, GT, GTE, GTR, SR, Sport	83 » 93	545179G	545179	JF	254995G	254995	GC
MK II  Except GLS, GSi, GT, GTE, SR, SRi, Sport	93 » 09.00	545179G	545179	JF	154935G	154935	SC
MK II GLS, GSi, GT, GTE, SR, SRi, Sport	93 » 09.00	545179G	545179	JF	254995G	254995	GC
<b>VAUXHALL ROYALE - SENATOR</b>							
<b>ROYALE - SENATOR</b>							
	78 » 08.87	444666G	444666	FU	151014G	151014	SC
	<sup>(2)</sup> 09.87 »				155131G	155131	SC
<b>VAUXHALL TIGRA</b>							
<b>TIGRA</b>							
	94 »	545179G	545179	JF	254995G	254995	GC
<b>VAUXHALL VECTRA</b>							
<b>VECTRA</b>							
  → T1086823	10.95 » 08.96	545278G L 545279G R	545278 L 545279 R	JF	355270G <sup>(1)</sup>	355270 <sup>(1)</sup>	SR
  T 1086824 → Except Sport	09.96 » 04.02	545278G L 545279G R	545278 L 545279 R	JF	355281G <sup>(1)</sup>	355281 <sup>(1)</sup>	SR





























MODELE MODEL	ANNEE / YEAR						
		AVANT / FRONT			ARRIÈRE / REAR		
		GAZ / GAS	HYD	TYPE	GAZ / GAS	HYD	TYPE
<b>VECTRA</b>							
 SPORT  T1086824 →	09.96 » 04.02				<sup>(1)</sup> 355281G	<sup>(1)</sup> 355281	SR
<b>VAUXHALL VICEROY</b>							
<b>VICEROY</b>							
	80 » 82	444666G	444666	FU	154327G	154327	SC
<b>VAUXHALL VICTOR - VX - VENTORA</b>							
<b>CRESTA - ENVOY - VISCOUNT</b>							
CRESTA (PA) - ENVOY - VISCOUNT (PB-PC)	57 » 72		161320	SC		171536	SC
<b>VICTOR - VX - VENTORA</b>							
VICTOR - VX - VENTORA	62 »		161403	SC		171327	SC
<b>FB Series</b>							
VX, VENTORA  → 3151343	62 » 63		161521	SC		171522	SC
VX, VENTORA  3151344 →	64 » 65		141773	SC		171522	SC
<b>FB , FC Series</b>							
VX, VENTORA	65 » 67		141773	SC		151844	SC
<b>FD Series</b>							
VX, VENTORA	68 » 71		101871	SC		151872	SC
<b>FE Series</b>							
VX, VENTORA  CY...	72 » 02.74		104689	SC	154489G	154489	SC
VX, VENTORA  DY...	03.74 »		104689	SC		154680	SC
VX, VENTORA 	72 »		104689	SC		154680	SC
<b>VAUXHALL VIVA</b>							
<b>HA</b>							
HA, EPIC HA 	63 » 66		141926	SC		101162	SC
HA, EPIC HA 	67 »		101748	SC		171749	SC
<b>HB</b>							
 → 162328	67 » 68		101803	SC		151992	SC

























MODELE MODEL	ANNEE / YEAR						
		AVANT / FRONT			ARRIÈRE / REAR		
		GAZ / GAS	HYD	TYPE	GAZ / GAS	HYD	TYPE
<b>HB</b>							
 (  ) 162329 →	69 » 70		101871	SC		151872	SC
 (  ) → 158035	67 » 68		101803	SC		151992	SC
 (  ) 158036 →	69 » 70		101871	SC		151872	SC
<b>HC</b>							
	71 » 79		101871	SC		151872	SC
<b>VOLGA</b>							
<b>M21 &amp; M24</b>							
STANDARD 	63 »	141529G	141529	SC	151520G	151520	SC
<b>VOLKSWAGEN</b>							
<b>VOLKSWAGEN 411 - 412</b>							
<b>411</b>							
 (  ) → 422.045.430	68 » 07.72	441995G	441995	FU	151996G	151996	SC
<b>412</b>							
 (  ) 422.045.431 →	06.72 » 07.73	444425G	444425	FU	151996G	151996	SC
	08.73 » 74				151996G	151996	SC
<b>VOLKSWAGEN 914</b>							
<b>914</b>							
914/4 - 914/6	69 » 76		441937	FU			
<b>VOLKSWAGEN 1200 ---&gt; 1500 COCCINELLE / BEETLE / KAEFER (TYPE I)</b>							
<b>1200</b>							
 (Buggy inclus)	53 » 07.65		111333	SC		111334	SC
<b>1200 - 1300 - 1500</b>							
 (Buggy, Mexico inclus) Essieu Arrière Simple Cardan/Rear Single Axle	08.65 » 79	141627G	141627	SC		101334	SC
<b>1300 - 1500</b>							
 (Buggy, Sportomatic inclus) Essieu Arrière Double Cardan/Rear Double Joint articulés Axle	05.67 » 79	141627G	141627	SC	111908G	111908	SC





















MODELE MODEL	ANNEE / YEAR						
		AVANT / FRONT			ARRIÈRE / REAR		
		GAZ / GAS	HYD	TYPE	GAZ / GAS	HYD	TYPE
<b>1302 - 1303</b>							
 Ch → 1333200000	70 » 07.73	441907G	441907	FU	111908G	111908	SC
<b>1303</b>							
 (  ) 1333200001 → 1342000000	08.73 » 04.75		444338	FU	111908G	111908	SC
 : (  ) 1342000001 →	05.75 » 79				111908G	111908	SC
<b>VOLKSWAGEN 1500 - 1600 (TYPE III)</b>							
<b>1500</b>							
	62 » 07.67		101404	SC		101334	SC
<b>1600</b>							
	62 » 07.67		101404	SC		101334	SC
	08.67 » 73		101404	SC	111908G	111908	SC
<b>VOLKSWAGEN BEETLE</b>							
<b>NEW BEETLE</b>							
 (9C, 1C)  (1Y) Except  , USA, MEX	98 » 12.11	545274G	545274	JF	155464G	155464	SC
<b>VOLKSWAGEN BORA Berline/Saloon</b>							
<b>BORA</b>							
(1J)  Except (SS)  Except 	97 » 08.05	545274G	545274	JF	155275G	155275	SC
(1J)  (+) (SS) Except  Except 	97 » 08.05	545274G	545274	JF	155464G	155464	SC
(1J)   Except (SS) 	97 » 08.05	545274G	545274	JF			
(1J)  (  ) → 1J.X.999000 Except (SS) Except 	98 » 04.99	545274G	545274	JF			













MODELE MODEL	ANNEE / YEAR						
		AVANT / FRONT			ARRIÈRE / REAR		
		GAZ / GAS	HYD	TYPE	GAZ / GAS	HYD	TYPE
<b>VOLKSWAGEN BORA Break/Estate</b>							
<b>BORA</b>							
(1J)  Except   Except 	99 » 08.05	545274G	545274	JF	155504G	155504	SC
(1J)  (+)  Except  Except 	99 » 08.05	545274G	545274	JF			
(1J)   Except  	99 » 08.05	545274G	545274	JF			
<b>VOLKSWAGEN CADDY</b>							
<b>CADDY 1</b>							
(14)  	82 » 12.95	444373G <sup>(2)</sup>	444373 <sup>(2)</sup>	FU	114802G	114802	SC
<b>CADDY 2</b>							
(9K) 	01.96 » 06.04	545201G <sup>(2)</sup>	545201 <sup>(2)</sup>	JF	115200G	115200	SC
(9K) 	01.96 » 12.03	545201G <sup>(2)</sup>	545201 <sup>(2)</sup>	JF	115200G	115200	SC
<b>CADDY 3</b>							
(2C, 2K)  5/7 Places/Seats Tube Jambe de Force : Ø Externe = 50mm Strut Outer Tube: External Ø (OD) = 50mm Except 	03.04 »	545611G	545611	JF	115758G	115758	SC
(2C, 2K)  5/7 Places/Seats Tube Jambe de Force : Ø Externe = 55mm Strut Outer Tube: External Ø (OD) = 55mm Except 	03.04 »	545612G	545612	JF	115758G	115758	SC





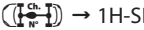
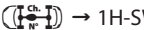

























MODELE MODEL	ANNEE / YEAR						
		AVANT / FRONT			ARRIÈRE / REAR		
		GAZ / GAS	HYD	TYPE	GAZ / GAS	HYD	TYPE
<b>CADDY 3</b>							
(2C, 2K)  5/7 Places/Seats Tube Jambe de Force : Ø Externe = 50mm Strut Outer Tube : External Ø (OD) = 50mm Except 	03.04 »	545611G	545611	JF	115758G	115758	SC
(2C, 2K)  5/7 Places/Seats Tube Jambe de Force : Ø Externe = 55mm Strut Outer Tube : External Ø (OD) = 55mm Except 	03.04 »	545612G	545612	JF	115758G	115758	SC
<b>VOLKSWAGEN CC</b>							
<b>CC</b>							
(358)  (4 Portes/Doors) Except 	12 »	545612G	545612	JF	255613G	255613	GC
<b>VOLKSWAGEN CRAFTER</b>							
<b>CRAFTER</b>							
(2E)   3T, 3,5T	05.06 »	545759G	545759	JF	215894G	215894	GC
(2E)   4.6T, 5T	05.06 »	545764G	545764	JF	215895G	215895	GC
(2F)   3T, 3,5T	05.06 »	545759G	545759	JF	215894G	215894	GC
(2F)   5T	05.06 »	545764G	545764	JF	215895G	215895	GC
<b>VOLKSWAGEN DERBY</b>							
<b>DERBY</b>							
	76 » 86	444492G	444492	FU	354493G	354493	SR
<b>VOLKSWAGEN EOS</b>							
<b>EOS</b>							
(1F)   Except V6 Sportline	06 » 02.10	545612G	545612	JF	255765G	255765	GC



















MODELE MODEL	ANNEE / YEAR						
		AVANT / FRONT			ARRIÈRE / REAR		
		GAZ / GAS	HYD	TYPE	GAZ / GAS	HYD	TYPE
<b>VOLKSWAGEN FOX</b>							
<b>FOX</b>							
	05 »	545566G	545566	JF	155564G	155564	SC
<b>VOLKSWAGEN GOLF I Berline/Saloon</b>							
<b>GOLF I</b>							
(17)  Except GLi, GTi	73 » 07.77	<sup>(2)</sup> 444373	<sup>(2)</sup> 444373	FU	354374G	354374	SR
(17)  Except GLi, GTi	08.77 » 08.83	<sup>(2) (3)</sup> 444373G	<sup>(2) (3)</sup> 444373	FU	354681G	354681	SR
(17) GLi, GTi	76 » 08.83	<sup>(2) (3)</sup> 444373G	<sup>(2) (3)</sup> 444373	FU	354681G	354681	SR
<b>VOLKSWAGEN GOLF II Berline/Saloon</b>							
<b>GOLF II</b>							
(19, G)  Except GTi, Syncro	09.83 » 12.89	444951G	444951	FU	354952G	354952	SR
(19, G) GTi Except GTi 16V	09.83 » 12.89	444998G	444998	FU	354952G	354952	SR
(19, G)  Except GTi, Syncro	01.90 » 08.91	<sup>(2)</sup> 544091G	<sup>(2)</sup> 544091	JF	354952G	354952	SR
(19, G) GTi Except GTi 16V, GTi G60	01.90 » 08.91	<sup>(2)</sup> 544092G	<sup>(2)</sup> 544092	JF	354952G	354952	SR
<b>VOLKSWAGEN GOLF III Berline/Saloon</b>							
<b>GOLF III</b>							
(1H)   → 1H-SB019475  → 1H-SW062538 Except GL, GLi, GT, GTi, VR6,  , Diesel, Syncro	09.91 » 07.94	<sup>(2)</sup> 544091G	<sup>(2)</sup> 544091	JF	354952G	354952	SR



















MODELE MODEL	ANNEE / YEAR						
		AVANT / FRONT			ARRIÈRE / REAR		
		GAZ / GAS	HYD	TYPE	GAZ / GAS	HYD	TYPE
<b>GOLF III</b>							
(1H)  GL, GLi, GT Diesel (TDi inclus)  → 1H-SB019475  → 1H-SW062538	09.91 » 07.94	(2) 544092G	(2) 544092	JF	354952G	354952	SR
(1H)    1H-SB019476 →  1H-SW062539 → Except GTi, TDi, VR6,  , Syncro	08.94 » 09.97	(2) 545201G	(2) 545201	JF	354952G	354952	SR
(1H)  TDi	01.94 » 09.97	(2) 545201G	(2) 545201	JF	354952G	354952	SR
<b>VOLKSWAGEN GOLF IV Berline/Saloon (1J)</b>							
<b>GOLF IV</b>							
(1J)    Except  ention  Except 	10.97 » 10.03	(1) 545274G	(1) 545274	JF	155275G	155275	SC
(1J)  (+)  Except R32,  	10.97 » 10.03	(1) 545274G	(1) 545274	JF	155464G	155464	SC
(1J)   Except 	10.97 » 10.03	(1) 545274G	(1) 545274	JF			
(1J)     → 1J.X.800000	10.97 » 05.99	(1) 545274G	(1) 545274	JF			







































MODELE MODEL	ANNEE / YEAR						
		AVANT / FRONT			ARRIÈRE / REAR		
		GAZ / GAS	HYD	TYPE	GAZ / GAS	HYD	TYPE
<b>VOLKSWAGEN GOLF V</b>							
<b>GOLF V</b>							
(1K1)  Tube Jambe de Force : Ø Externe = 50mm Strut Outer Tube : External Ø (OD) = 50mm Except (SS)  Except GT Sport, GTi Turbo, R32, R36 Except 	11.03 » 09.08	(4) 545611G	(4) 545611	JF	(4) 255613G	(4) 255613	(4) GC
(1K1)  Tube Jambe de Force : Ø Externe = 55mm Strut Outer Tube : External Ø (OD) = 55mm Except (SS)  , GT Sport, GTi Turbo, R32, R36 Except 	11.03 » 09.08	(4) 545612G	(4) 545612	JF	(4) 255613G	(4) 255613	(4) GC
(1K1)  Tube Jambe de Force : Ø Externe = 50mm Strut Outer Tube : External Ø (OD) = 50mm (+) (SS) Except  	11.03 » 09.08				(4) 255613G	(4) 255613	(4) GC
(1K1)  Tube Jambe de Force : Ø Externe = 55mm Strut Outer Tube : External Ø (OD) = 55mm (+) (SS) Except  	11.03 » 09.08				(4) 255613G	(4) 255613	(4) GC
(1K5)  Except (SS) Except 	06.07 » 08.09	(4) 545612G	(4) 545612	JF	(4) 255613G	(4) 255613	(4) GC

























MODELE MODEL	ANNEE / YEAR						
		AVANT / FRONT			ARRIÈRE / REAR		
		GAZ / GAS	HYD	TYPE	GAZ / GAS	HYD	TYPE
<b>VOLKSWAGEN GOLF VI</b>							
<b>GOLF VI</b>							
(5K1)  Tube Jambe de Force : Ø Externe = 50mm Strut Outer Tube : External Ø (OD) = 50mm Except (SS)  Except GTi, GTD , R Except 	10.08 » 08.12	(4) 545611G	(4) 545611	JF	(4) 255613G	(4) 255613	(4) GC
(5K1)  Tube Jambe de Force : Ø Externe = 55mm Strut Outer Tube : External Ø (OD) = 55mm Except (SS)  Except GTi, GTD , R Except 	10.08 » 08.12	(4) 545612G	(4) 545612	JF	(4) 255613G	(4) 255613	(4) GC
(5K1)  Tube Jambe de Force : Ø Externe = 50mm Strut Outer Tube : External Ø (OD) = 50mm (+) (SS) Except  	10.08 » 08.12				(4) 255613G	(4) 255613	(4) GC
(5K1)  Tube Jambe de Force : Ø Externe = 55mm Strut Outer Tube : External Ø (OD) = 55mm (+) (SS) Except  	10.08 » 08.12				(4) 255613G	(4) 255613	(4) GC
(AJ5)  Except (SS)  Except 	09.09 » 05.13	(4) 545612G	(4) 545612	JF	(4) 255613G	(4) 255613	(4) GC



















MODELE MODEL	ANNEE / YEAR						
		AVANT / FRONT			ARRIÈRE / REAR		
		GAZ / GAS	HYD	TYPE	GAZ / GAS	HYD	TYPE
<b>VOLKSWAGEN GOLF VII</b>							
<b>GOLF VII</b>							
(5G1):   (BA5):   Tube Jambe de Force : Ø Externe = 50mm Strut Outer Tube : External Ø (OD) = 50mm  Except Susp,  (SS) Except GTi, GTD,  	10.12 » 06.13 »	545809G	545809	JF	255911G	255911	GC
(5G1):   (BA5):   Tube Jambe de Force : Ø Externe = 55mm Strut Outer Tube : External Ø (OD) = 55mm  Except Susp,  (SS) Except GTi, GTD,  	10.12 » 06.13 »	545800G	545800	JF	255911G	255911	GC
(5G1):   (BA5):   Tube Jambe de Force : Ø Externe = 50mm Strut Outer Tube : External Ø (OD) = 50mm (+)  AR/Rear Except (SS), GTi, GTD,  Except 	10.12 » 06.13 »	545800G	545800	JF	255924G	255924	GC
(5G1):   (BA5):   Tube Jambe de Force : Ø Externe = 55mm Strut Outer Tube : External Ø (OD) = 55mm (+)  AR/Rear Except (SS), GTi, GTD,  Except 	10.12 » 06.13 »	545800G	545800	JF	255924G	255924	GC
<b>VOLKSWAGEN GOLF CABRIOLET</b>							
<b>GOLF I</b>							
(155)  	79 » 93	<sup>(2) (3)</sup> 444373G	<sup>(2) (3)</sup> 444373	FU	354681G	354681	SR
CADDY   	82 » 95	<sup>(2) (3)</sup> 444373G	<sup>(2) (3)</sup> 444373	FU	114802G	114802	SC



















MODELE MODEL	ANNEE / YEAR						
		AVANT / FRONT			ARRIÈRE / REAR		
		GAZ / GAS	HYD	TYPE	GAZ / GAS	HYD	TYPE
<b>GOLF III</b>							
(E1) 	01.94 » 03.98	544092G <sup>(2)</sup>	544092 <sup>(2)</sup>	JF	354952G	354952	SR
(1H)  (F) → 1H-SB019475 (F) → 1H-SW062538	93 » 07.94	544092G <sup>(2)</sup>	544092 <sup>(2)</sup>	JF	355226G	355226	SR
(1H)  (F) 1H-SB019476 → (F) 1H-SW062539 →	08.94 » 06.99	545201G <sup>(2)</sup>	545201 <sup>(2)</sup>	JF	355226G	355226	SR
<b>GOLF IV</b>							
(1H)  Except 	04.98 » 05	544092G <sup>(2)</sup>	544092 <sup>(2)</sup>	JF	354952G	354952	SR
(1H)  (+) 	04.98 » 05	544092G <sup>(2)</sup>	544092 <sup>(2)</sup>	JF			
(1J)  Except  	07.99 » 05.07	545274G	545274	JF	155504G	155504	SC
(1J)  Except 	07.99 » 05.07	545274G	545274	JF			
<b>VOLKSWAGEN GOLF PLUS</b>							
<b>GOLF PLUS</b>							
(1KP, 5M)  Tube Jambe de Force : Ø Externe = 50mm Strut Outer Tube : External Ø (OD) = 50mm Except  	03.05 »	545611G	545611	JF	255613G	255613	GC
(1KP, 5M)  Tube Jambe de Force : Ø Externe = 55mm Strut Outer Tube : External Ø (OD) = 55mm Except  	03.05 »	545612G	545612	JF	255613G	255613	GC





























MODELE MODEL	ANNEE / YEAR						
		AVANT / FRONT			ARRIÈRE / REAR		
		GAZ / GAS	HYD	TYPE	GAZ / GAS	HYD	TYPE
<b>VOLKSWAGEN JETTA</b>							
<b>JETTA I</b>							
(17) 	79 » 08.83	<sup>(2) (3)</sup> 444373G	<sup>(2) (3)</sup> 444373	FU	354681G	354681	SR
<b>JETTA II</b>							
(19, 1G)  Except GT 16V, Syncro	09.83 » 12.89	444951G	444951	FU	354952G	354952	SR
(19, 1G)  Except GL, GT 16V, GTX, Syncro , Diesel	01.90 » 92	<sup>(2)</sup> 544091G	<sup>(2)</sup> 544091	JF	354952G	354952	SR
(19, 1G) GL, Diesel	01.90 » 92	<sup>(2)</sup> 544092G	<sup>(2)</sup> 544092	JF	354952G	354952	SR
<b>JETTA III</b>							
(1K2)  Tube Jambe de Force : Ø Externe = 50mm Strut Outer Tube : External Ø (OD) = 50mm Except  	08.05 » 12.10	<sup>(2)</sup> 545611G	<sup>(2)</sup> 545611	JF	255613G	255613	GC
(1K2)  Tube Jambe de Force : Ø Externe = 55mm Strut Outer Tube : External Ø (OD) = 55mm Except  	08.05 » 12.10	<sup>(2)</sup> 545612G	<sup>(2)</sup> 545612	JF	255613G	255613	GC
<b>JETTA IV</b>							
(162)  Tube Jambe de Force : Ø Externe = 50mm Strut Outer Tube : External Ø (OD) = 50mm Except  	01.11 »	<sup>(2)</sup> 545611G	<sup>(2)</sup> 545611	JF	255613G	255613	GC
(162)  Tube Jambe de Force : Ø Externe = 55mm Strut Outer Tube : External Ø (OD) = 55mm Except  	01.11 »	<sup>(2)</sup> 545612G	<sup>(2)</sup> 545612	JF	255613G	255613	GC







































MODELE MODEL	ANNEE / YEAR						
		AVANT / FRONT			ARRIÈRE / REAR		
		GAZ / GAS	HYD	TYPE	GAZ / GAS	HYD	TYPE
<b>VOLKSWAGEN K70</b>							
<b>K70</b>							
	70 » 76		444164	FU			
<b>VOLKSWAGEN LT - SERIES</b>							
<b>LT</b>							
28, 31, 35 (D inclus)  → 007273	75 » 11.82	244826G	244826	GC			
28, 28D, 31, 31D - 35, 35D, 35TD  007274 →	12.82 » 04.96	244826G	244826	GC			
(2D) 28, 32, 35	05.96 » 06	545540G	545540	JF	215238G	215238	GC
(2D) 46	05.96 » 06	545610G	545610	JF	215639G	215639	GC
<b>VOLKSWAGEN LUPO</b>							
<b>LUPO</b>							
(6X, 6E)  Except 1.2 TDi, 1.4 FSi, 1.6 GTi	97 » 10	545201G <sup>(2)</sup>	545201 <sup>(2)</sup>	JF	155467G	155467	SC
(6X, 6E) 1.2 TDi, 1.4 FSi, 1.6 GTi 16V	97 » 10				155467G	155467	SC
<b>VOLKSWAGEN PASSAT I &amp; II</b>							
<b>PASSAT I</b>							
(32) 	73 » 09.80		444126	FU	114347G	114347	SC
(33) 	73 » 09.80		444126	FU	114242G	114242	SC
<b>PASSAT II</b>							
(32B)    → 155757	10.80 » 04.83	444869G	444869	FU	354806G	354806	SR
(32B)  Except Syncro  155758 →	05.83 » 03.88	444869G	444869	FU	354912G	354912	SR
(32B)  SYNCRO	84 » 03.88	444869G	444869	FU			
(32B)   → 155757	10.80 » 04.83	444869G	444869	FU	354806G	354806	SR





































MODELE MODEL	ANNEE / YEAR						
		AVANT / FRONT			ARRIÈRE / REAR		
		GAZ / GAS	HYD	TYPE	GAZ / GAS	HYD	TYPE
<b>PASSAT II</b>							
(32B)  Except Syncro  155758 →	05.83 » 03.88	444869G	444869	FU	354912G	354912	SR
(32B)  SYNCRO	84 » 03.88	444869G	444869	FU			
<b>VOLKSWAGEN PASSAT III</b>							
<b>PASSAT III</b>							
(3A2):  (3A5):   Except VR6, Syncro,   → 31P026435	04.88 » 92	(2) 545134G	(2) 545134	JF	(7) 355135G	(7) 355135	SR
(3A2)  Except VR6, Syncro,   31P026436 →	93 » 09.96	(2) 545255G	(2) 545255	JF	(7) 355135G	(7) 355135	SR
(3A5)  Except VR6, Syncro,   31P026436 →	93 » 04.97	(2) 545255G	(2) 545255	JF	(7) 355135G	(7) 355135	SR
<b>VOLKSWAGEN PASSAT IV</b>							
<b>PASSAT IV</b>							
(3B2)  Except  , Syncro,   → 3B-YE121221	10.96 » 09.99	(8) 345276G	(8) 345276	SR	(7) (8) 155373G	(7) (8) 155373	SC
(3B5)  Except  , Syncro,   → 3B-YE121221	05.97 » 09.99	(8) 345276G	(8) 345276	SR	(7) (8) 155373G	(7) (8) 155373	SC
(3B2)  (+)  Except Syncro,   → 3B-YE121221	10.96 » 09.99	(8) 345372G	(8) 345372	SR	(7) (8) 155373G	(7) (8) 155373	SC































MODELE MODEL	ANNEE / YEAR						
		AVANT / FRONT			ARRIÈRE / REAR		
		GAZ / GAS	HYD	TYPE	GAZ / GAS	HYD	TYPE
<b>PASSAT IV</b>							
(3B5)  (+) (SS) Except Syncro,   → 3B-YE121221	05.97 » 09.99	(8) 345372G	(8) 345372	SR	(7) (8) 155373G	(7) (8) 155373	SC
(3B2)  Syncro  Except (SS)   → 3B-YE121221	10.96 » 09.99	(8) 345276G	(8) 345276	SR			
(3B5)  Syncro  Except (SS)   → 3B-YE121221	08.97 » 09.99	(8) 345276G	(8) 345276	SR			
(3B2)  Syncro  (SS)  → 3B-YE121221 Except 	10.96 » 09.99	(8) 345372G	(8) 345372	SR			
(3B5)  Syncro  (SS)  → 3B-YE121221 Except 	08.97 » 09.99	(8) 345372G	(8) 345372	SR			
<b>VOLKSWAGEN PASSAT V</b>							
<b>PASSAT V</b>							
(3B3)   (+) (SS)  3B-YE121222 → Except W8,  	10.99 » 02.05	(9) 345667G	(9) 345667	SR	(7) (9) 155373G	(7) (9) 155373	SC
(3B6)   (+) (SS)  3B-YE121222 → Except W8,  	10.99 » 08.05	(9) 345667G	(9) 345667	SR	(7) (9) 155373G	(7) (9) 155373	SC
(3B3)    3B-YE121222 → Except  	10.99 » 02.05	(9) 345680G	(9) 345680	SR			



















MODELE MODEL	ANNEE / YEAR						
		AVANT / FRONT			ARRIÈRE / REAR		
		GAZ / GAS	HYD	TYPE	GAZ / GAS	HYD	TYPE
<b>PASSAT V</b>							
(3B6)    3B-YE121222 → Except  	10.99 » 08.05	<sup>(9)</sup> 345680G	<sup>(9)</sup> 345680	SR			
(3B3)   3B-YE121222 → Except  	10.99 » 02.05	<sup>(9)</sup> 345667G	<sup>(9)</sup> 345667	SR			
(3B6)   3B-YE121222 → Except  	10.99 » 08.05	<sup>(9)</sup> 345667G	<sup>(9)</sup> 345667	SR			
(3B3)    3B-YE121222 → Except 	10.99 » 02.05	<sup>(9)</sup> 345680G	<sup>(9)</sup> 345680	SR			
(3B6)    3B-YE121222 → Except 	10.99 » 08.05	<sup>(9)</sup> 345680G	<sup>(9)</sup> 345680	SR			
<b>VOLKSWAGEN PASSAT VI</b>							
<b>PASSAT VI</b>							
(3C2)   Except  	<sup>(5)</sup> 03.05 » 07.10	<sup>(9)</sup> 545612G	<sup>(9)</sup> 545612	JF	<sup>(9)</sup> 255613G	<sup>(9)</sup> 255613	GC
(357)  - Confort  Except 	<sup>(5)</sup> 06.08 »	<sup>(9)</sup> 545612G	<sup>(9)</sup> 545612	JF	<sup>(9)</sup> 255613G	<sup>(9)</sup> 255613	GC
(3C5)   Except  	<sup>(5)</sup> 09.05 » 07.10	<sup>(9)</sup> 545612G	<sup>(9)</sup> 545612	JF	<sup>(9)</sup> 255613G	<sup>(9)</sup> 255613	GC







































MODELE MODEL	ANNEE / YEAR						
		AVANT / FRONT			ARRIÈRE / REAR		
		GAZ / GAS	HYD	TYPE	GAZ / GAS	HYD	TYPE
<b>VOLKSWAGEN PASSAT VII</b>							
<b>PASSAT VII</b>							
(362)   Except   Except  	(5) 08.10 » 10.14	(10) 545612G	(10) 545612	JF	(10) 255613G	(10) 255613	GC
(365)   Except   Except  	(5) 08.10 » 10.14	(10) 545612G	(10) 545612	JF	(10) 255613G	(10) 255613	GC
<b>VOLKSWAGEN POLO</b>							
<b>POLO I &amp; II</b>							
(80, 86)  Except G40	75 » 07.94	444492G	444492	FU	354493G	354493	SR
<b>POLO III</b>							
(6N)   Except  Classic, Flight	08.94 » 10.01	(2) (6) 545201G	(2) (6) 545201	JF	(11) 355242G	(11) 355242	SR
(6N)  Classic, Flight	96 » 10.01	(2) 545201G	(2) 545201	JF	(11) 355242G	355242	SR
(6K) 	96 » 10.01	(2) 545201G	(2) 545201	JF	355538G	355538	SR
(6K)  Except Caddy	96 » 10.01	(2) (6) 545201G	(2) (6) 545201	JF	115200G	115200	SC
(9K)  Caddy	96 » 04	(2) 545201G	(2) 545201	JF	115200G	115200	SC
<b>POLO IV</b>							
(9N)   Except  	11.01 » 05.09	(12) 545566G	(12) 545566	JF	(12) 155567G	(12) 155567	SC
(9N)    Except 	11.01 » 05.09	(12) 545501G	(12) 545501	JF	(12) 155503G	(12) 155503	SC
(9N)   	11.01 » 05.09	(12) 545501G	(12) 545501	JF	(12) 155502G	(12) 155502	SC









MODELE MODEL	ANNEE / YEAR						
		AVANT / FRONT			ARRIÈRE / REAR		
		GAZ / GAS	HYD	TYPE	GAZ / GAS	HYD	TYPE
<b>POLO V</b>							
(6R)  Except GTI	06.09 »	545751G	545751	JF	155567G	155567	SC
<b>VOLKSWAGEN SANTANA</b>							
<b>SANTANA</b>							
 (  ) → 32 D 155757	81 » 08.83	155567G	155567	JF	354806G	354806	SR
 (  ) 32 D 155758 →	09.83 » 86	155567G	155567	JF	354912G	354912	SR
<b>VOLKSWAGEN SCIROCCO</b>							
<b>SCIROCCO</b>							
(53)  Except GLi, GTi	73 » 07.77	444373G <sup>(2)</sup>	444373 <sup>(2)</sup>	FU	354374G	354374	SR
(53B)  Except GLi, GTi, GT 16V	08.77 »	444373G <sup>(2)</sup>	444373 <sup>(2)</sup>	FU	354681G	354681	SR
(53B) GLi, GTi Except GT 16V	76 »	444373G <sup>(2) (3)</sup>	444373 <sup>(2) (3)</sup>	FU	354681G	354681	SR
<b>NEW SCIROCCO</b>							
(137)  Except (SS), R	08 »	354681G	354681	JF	255613G	255613	GC
<b>VOLKSWAGEN SHARAN</b>							
<b>SHARAN I</b>							
	95 » 06.10	545336G	545336	JF	115337G <sup>(7)</sup>	115337 <sup>(7)</sup>	SC
<b>SHARAN II</b>							
 Except 	07.10 »	545612G	545612	JF	255836G	255836	GC
<b>VOLKSWAGEN TARO</b>							
<b>TARO</b>							
CL, GL  	89 »	144072G	144072	SC	219358G		GC
CL  Standard, Double Cabines	89 »	744073G	744073	PLL	214074G		GC







MODELE MODEL	ANNEE / YEAR						
		AVANT / FRONT			ARRIÈRE / REAR		
		GAZ / GAS	HYD	TYPE	GAZ / GAS	HYD	TYPE
<b>TARO</b>							
CL, GL  Extra Cabine	89 »	744075G	744075	PLL	214076G		GC
<b>VOLKSWAGEN TIGUAN</b>							
<b>TIGUAN</b>							
(5N)    Except (SS)	(5) 07 »	545857G	545857	JF	255858G	255858	GC
(5N)    (+) (SS)	(5) 07 »	545857G	545857	JF	255858G	255858	GC
<b>VOLKSWAGEN TOURAN</b>							
<b>TOURAN</b>							
(T1, T2, T3)  	03 » 08.15	545614G	545614	JF	255616G	255616	GC
<b>VOLKSWAGEN TRANSPORTER / CARAVELLE (TYPE II)</b>							
<b>TRANSPORTER</b>							
 	53 » 07.67		111334	SC		111334	SC
 	08.67 » 07.69		101808	SC	111700G	111700	SC
 	08.69 » 07.71	104158G	104158	SC	111700G	111700	SC
 	08.71 » 12.78	104158G	104158	SC	114159G	114159	SC
   Except Syncro	01.79 » 90	744938G	744938	PLL	214939G	214939	GC
  Syncro	01.79 » 90					214930	GC
<b>VOLKSWAGEN TRANSPORTER T4 / CARAVELLE (TYPE IV)</b>							
<b>TRANSPORTER</b>							
  (California Coach, Multivan, Syncro inclus)	09.90 » 04.03	745458G	745458	PLL	735459G	735459	PLL
 (Syncro inclus)	94 » 12.03	745458G	745458	PLL	735459G	735459	PLL
<b>VOLKSWAGEN TRANSPORTER T5</b>							
<b>TRANSPORTER</b>							
   Except 	05.03 »					115660	SC
  Except 	01.04 »					115660	SC

















MODELE MODEL	ANNEE / YEAR						
		AVANT / FRONT			ARRIÈRE / REAR		
		GAZ / GAS	HYD	TYPE	GAZ / GAS	HYD	TYPE
<b>VOLKSWAGEN UP</b>							
<b>UP</b>							
 Except GT	11 »				155875G	155875	SC
<b>VOLKSWAGEN VENTO</b>							
<b>VENTO</b>							
(1H)  Except GT, VR6, (SS), Diesel (T) → 1H-SB019475, 1H-SW062538	92 » 07.94	(2) 544091G	(2) 544091	JF	354952G	354952	SR
(1H)  Diesel (T) → 1H-SB019475, 1H-SW062538	92 » 07.94	(2) 544092G	(2) 544092	JF	354952G	354952	SR
(1H)  (+) (SS) (T) 1H-SB019476, 1H-SW062539 → Except GT, TDi, VR6	08.94 »	(2) 545201G	(2) 545201	JF	354952G	354952	SR
(1H) TDi	01.94 »	(2) 545201G	(2) 545201	JF	354952G	354952	SR



## VOLVO

<b>VOLVO 66 --&gt; 960</b>							
<b>66</b>							
(Daf 66)	75 » 80		441971	FU		174393	SC
<b>140 &amp; 160 Series</b>							
	66 » 08.71		141668	SC			
	09.71 » 74		141668	SC		114104	SC
<b>240 &amp; 260Series</b>							
	74 » 93	444394G (2)	444394 (2)	FU	114395G (1)	114395 (1)	SC
<b>340 &amp; 360 Series</b>							
 Except, 360 GLT	76 »	444667G	444667	FU	174668G	174668	SC
<b>440 &amp; 460 &amp; 480 Series</b>							
	85 »	545282G	545282	JF	115262G	115262	SC





MODELE MODEL	ANNEE / YEAR						
		AVANT / FRONT			ARRIÈRE / REAR		
		GAZ / GAS	HYD	TYPE	GAZ / GAS	HYD	TYPE
<b>740 &amp; 760 Series</b>							
 (  ) → 81679	82 » 04.84				<sup>(1)</sup> 114029G	<sup>(1)</sup> 114029	SC
 Essieu Rigide à l'Arrière/Rigid Rear Axle (  ) 81680 →	05.84 » 92	444028G	444028	FU	<sup>(1)</sup> 114029G	<sup>(1)</sup> 114029	SC
 Roues Independantes AR/Rear (  ) 81680 →	05.84 » 92	444028G	444028	FU			
<b>780 Series</b>							
Essieu Rigide AR/Rear	85 » 07.87	444028G	444028	FU	<sup>(1)</sup> 114029G	<sup>(1)</sup> 114029	SC
Roues Independantes AR/Rear	08.87 »	444028G	444028	FU			
<b>940 Series</b>							
 Except Turbo 16V	90 »	444028G	444028	FU	<sup>(1)</sup> 114029G	<sup>(1)</sup> 114029	SC
Turbo 16V	90 »	444028G	444028	FU			
<b>960 Series</b>							
 (  ) → R048299	90 » 08.94	444028G	444028	FU			
 (  ) → R018099	90 » 08.94	444028G	444028	FU	114029G	114029	SC
<b>VOLVO A --&gt; Z</b>							
<b>P120 &amp; P130 Series</b>							
AMAZON Favorit	57 » 70		161460	SC		171471	SC
<b>P210</b>							
Duett	57 » 69		101468	SC	211765G	211765	GC
<b>P220Series</b>							
AMAZON 	62 » 70		161460	SC			
<b>P1800 &amp; 1800 S</b>							
	61 » 73		161404	SC		171363	SC
<b>PV</b>							
PV 444, 544	45 » 66		101468	SC		151469	SC
PV 445	57 » 69		101468	SC	211765G	211765	GC
<b>WARTBURG</b>							
<b>1000</b>							
	57 »		101641	SC		101641	SC





MODELE MODEL	ANNEE / YEAR						
		AVANT / FRONT			ARRIÈRE / REAR		
		GAZ / GAS	HYD	TYPE	GAZ / GAS	HYD	TYPE
<b>313 - 353</b>							
	67 »		101641	SC		101641	SC
<b>BARKAS</b>							
BARKAS	62 » 65		141706	SC		141706	SC
BARKAS	66 »					141706	SC

## WILLYS

<b>WILLYS (4x2 / 4x4)</b>							
<b>JEEP</b>							
ARMY, M201, 24 Volts (Hotchkiss inclus.)			101507	SC		111508	
Military Jeep, Ambulance MD	54 »		101162	SC		111163	SC
ARMY JH 102 Hotchkiss	54 »		101162	SC		111163	SC
CJ5, CJ6, CJ7, DJ5, DJ6 (Moteur/Engine USA)	55 » 81		101162	SC		111163	SC
CJ2A, CJ3A, CJ2B Dispatcher DJ3A	45 »		101162	SC		111162	
<b>CHEROKEE &amp; WAGONEER</b>							
	76 » 83	104770G	104770	SC	114781G	114781	SC
XJ	84 » 90	244019G	244019	GC	214010G	214010	GC
<b>GRAND CHEROKEE &amp; GRAND WAGONEER</b>							
	84 » 91	104770G	104770	SC	114781G	114781	SC
Except Special Suspension	92 » 94	244019G	244019	GC			
<b>COMMANCHE</b>							
(MJ) 	86 » 92	244019G	244019	GC			
<b>LAREDO &amp; RENEGADE</b>							
CJ7	82 » 86	204891G	204891	GC	214880G	214880	GC
<b>PIONNER</b>							
J10, J20 	74 »	104770G	104770	SC	114781G	114781	SC
<b>UNIVERSAL JEEP</b>							
CJ6, CJ7, CJ8 (Moteur/Engine RENAULT)	82 » 86				214880G	214880	GC
CJ5, C17 (Moteur/Engine USA)	82 » 86	104770G	104770	SC		111163	SC



MODELE MODEL	ANNEE / YEAR						
		AVANT / FRONT			ARRIÈRE / REAR		
		GAZ / GAS	HYD	TYPE	GAZ / GAS	HYD	TYPE

## WOLSELEY

HORNET							
	62 » 67	101495G	101495	SC	151495G	151495	SC

## ZASTAVA

101 & 128							
55, 65 (Skala inclus) GTL					554852G	554852	JF
125							
P	74 » 79		141496		151801G	151801	SC
PZ	64 » 74		141496	SC	151762G	151762	SC
750							
	64 »	161544G	161544	SC	171386G	171386	SC
1300 & 1500							
	64 » 74		141496	SC	151762G	151762	SC
YUGO							
45, 55, 65 Koral inclus	80 »	544913G	544913	JF	554852G	554852	JF
311, 511 (1100), 313, 513 (1300)		544813G	544813	JF	554852G	554852	JF
MIAMI, FLORIDA	89 »	544828G	544828	JF	354952G	354952	SR







## CHRYSLER

- (1) Sauf véhicules avec système automatique de réglage de niveau / Except vehicles with automatic levelling device  
 (2) ATTENTION : Après remplacement des jambes de force; me réglage du train avant est impératif  
 Caution : After fitting new front struts, wheel camber angle and steering alignment should always be checked

## CITROËN

- (1) ou / or 444971G / 444971 Jusqu'à épuisement du stock / while stocks last  
 (2) Poids indiqué en Kg = Charge Utile = poids Total en charge - poids à vide = (F.2) - (G.1) sur Certificat d'Immatriculation  
 Mentionned Weight in Kg : s = Payload/Live Weight )= Total Laden Weight - Unloaded Weight = (F.2) - (G.1) on Registration certificate  
 (3) CITROEN C3 phase 2 / DS3 / Peugeot 208 Avant / Front:  
 Ø Intérieur Pivot / Hyb internal Ø = 47 mm  
 545784G / 545784 = Gauche / Left  
 545785G / 545785 = Droite / Right



Ø Intérieur Pivot / Hyb internal Ø = 51 mm  
 545703G / 545703 = Gauche / Left  
 545704G / 545704 = Droite / Right

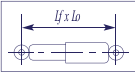
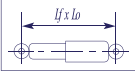
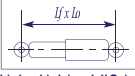
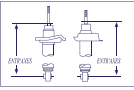

- (4) Sauf véhicules avec système automatique de réglage de niveau / Except vehicles with automatic levelling device  
 (5) Except Camping Car  
 (6) CITROEN EVASION / FIAT ULYSSE / LANCIA ZETA / PEUGEOT 806 Arrière / Rear  

 Lf = Longueur Fermée / Closed Length    Lo = Longueur Ouverte / Extended Length  
 Si / If Lf \* Lo = 262 \* 380, alors monter la référence / then fit part number 215245 ou / or 215245G  
 Si / If Lf \* Lo = 290 \* 408, alors monter la référence / then fit part number 215468 ou / or 215468G  
 (7) CITROEN JUMPER / FIAT DUCATO / PEUGEOT BOXER Arrière / Rear:  

 Lf = Longueur Fermée / Closed Length    Lo = Longueur Ouverte / Extended Length  
 Si / If Lf \* Lo = 283 \* 418 alors monter / then fit 715861  
 Si / If Lf \* Lo = 293 \* 444 alors monter / then fit 715862  
 Si / If Lf \* Lo = 315 \* 476 alors monter / then fit 715863  
 (8) CITROEN JUMPY / FIAT SCUDO / PEUGEOT EXPERT Arrière / Rear  

 Lf = Longueur Fermée / Closed Length    Lo = Longueur Ouverte / Extended Length  
 Si / If Lf \* Lo = 262 \* 380, alors monter la référence / then fit part number 215296 ou / or 215296G  
 Si / If Lf \* Lo = 290 \* 408, alors monter la référence / then fit part number 215475 ou / or 215475G  
 (9) LN - LNA - VISA Arrière / Rear  

 354883 : ENTR'AXES = 385 \* 583  
 354580 & 354580G : ENTRAXE S = 410 \* 581  
 354627 & 354627G : ENTRAXE S = 410 \* 645  
 354711 & 354711G : ENTRAXE S = 410 \* 617  
 (10) Si véhicule équipés de Jambes de Force serties, monter les références 544819 ou 544819G  
 If vehicle equipped with sealed struts, fit part number 544819 or 544819G  
 (11) CITROEN ZX - N°OPR :  
 Situé sur le renfort de la fixation supérieure de l'amortisseur gauche, à proximité du code peinture  
 Located on the reinforcement of the upper mounting of the left-hand shock absorber, close to the painting code  
 (12) ou / or 544096 / 544096G JF (Gauche / Left Hand & Droite / Right Hand) Jusqu'à épuisement du stock / while stock last  
 (!): 544097(G) JFG et 545098(G) JFD ont été remplacées par 545163(G) JFG et 545164(G) JFD



## DAIHATSU

- (1) Sauf véhicules avec amortisseurs réglables par système électronique / Except vehicles with electronically adjustable shock absorbers

## FIAT

- (1) Sauf véhicules avec système automatique de réglage de niveau / Except vehicles with automatic levelling device
- (2) Référence d'origine / Original part N°      Référence SIA'AM      Référence d'origine / Original part n°      Référence SIA'AM
- |           |        |            |        |
|-----------|--------|------------|--------|
| 4.829.233 | 204051 | 4.850.528  | 214023 |
| 4.829.234 | 204908 | 8.574.216  | 204969 |
| 4.829.235 | 214052 | 8.586.273  | 214994 |
| 4.835.372 | 214023 | 8.587.219  | 204969 |
| 4.835.375 | 214023 | 93.803.675 | 204051 |
| 4.843.748 | 214994 | 93.803.892 | 204051 |
| 4.843.749 | 214994 |            |        |
- (3) Poids indiqué en Kg = Charge Utile = poids Total en charge - poids à vide = (F.2) - (G.1) sur Certificat d'Immatriculation  
Mentioned Weight in Kg : s = Payload/Live Weight = Total Laden Weight - Unloaded Weight = (F.2) - (G.1) on Registration certificate
- (4) Si n° origine / if original n° = 4434812, 4439194, 5965476, 5983928 ou / or 7534624, monter / fit 214809  
Si n° origine / if original n° = 7576729, monter / fit 214963
- (5) Except Camping Car
- (6) CITROEN JUMPER / FIAT DUCATO / PEUGEOT BOXER Arrière / Rear:
- 
- Lf = Longueur Fermée / Closed Length      Lo = Longueur Ouverte / Extended Length  
Si / If Lf \* Lo = 283 \* 418 alors monter / then fit 715861  
Si / If Lf \* Lo = 293 \* 444 alors monter / then fit 715862  
Si / If Lf \* Lo = 315 \* 476 alors monter / then fit 715863
- (7) FIAT PALIO: Si le véhicule est équipé de Jambes de Force non serties, il est possible de monter la référence 445529 FU  
If the vehicle is equipped with non-sealed struts, it is possible to fit part n°445529 FU
- (8) ATTENTION: Après remplacement des jambes de force, le réglage du train avant est impératif  
CAUTION: After fitting new front struts, wheel camber angle and steering alignment should always be checked
- (9) CITROEN JUMPY / FIAT SCUDO / PEUGEOT EXPERT Arrière / Rear
- 
- Lf = Longueur Fermée / Closed Length      Lo = Longueur Ouverte / Extended Length  
Si / If Lf \* Lo = 262\*380, alors monter la référence / then fit part number 215296 ou / or 215296G  
Si / If Lf \* Lo = 290\*408, alors monter la référence / then fit part number 215475 ou / or 215475G
- (10) CITROEN EVASION / FIAT ULYSSE / LANCIA ZETA / PEUGEOT 806 Arrière / Rear
- 
- Lf = Longueur Fermée / Closed Length      Lo = Longueur Ouverte / Extended Length  
Si / If Lf \* Lo = 262 \* 380, alors monter la référence / then fit part number 215245 ou / or 215245G  
Si / If Lf \* Lo = 290\*408, alors monter la référence / then fit part number 215468 ou / or 215468G



**FORD**

- (1) Sauf véhicules avec amortisseurs réglables par système électronique / Except vehicles with electronically adjustable shock absorbers
- (2) Le support élastique supérieur, sur lequel est fixée la tige de la cartouche, comprend:  
The upper adjusting plate, in which the rod of the insert is fitted, includes:  
- Soit 1 roulement pour la référence / Either 1 ball-bearing for part n 441770  
- Soit 2 roulements pour la référence / or 2 ball-bearings for part n 441772  
- Soit 1 bloc élastique pour la référence / or 1 elastic bloc for part n 441821
- (3) ou / or 545218 / 545218G JF Jusqu'à épuisement du stock / While stocks last
- (4) FORD EUROPE : ORION  
FORD ESCORT & ORION Avant / Front  
Mois & Année de production : voir 11<sup>ème</sup> & 12<sup>ème</sup> codes du numéro dans la série du type (Numéro d'identification)  
Month & Year of Production : see 11th & 12th digits of the vehicle identification number

Année Year	11 <sup>ème</sup> code 11 <sup>th</sup> digit	Mois = 12 <sup>ème</sup> code / Month = 12 <sup>th</sup> digit											
		01	02	03	04	05	06	07	08	09	10	11	12
1983	D	C	K	D	E	L	Y	S	T	J	U	M	P
1984	E	B	R	A	G	C	K	D	E	L	Y	S	T
1985	F	J	U	M	P	B	R	A	G	C	K	D	E
1986	G	L	Y	S	T	J	U	M	P	B	R	A	G
1990	L	L	Y	S	T	J	U	M	P	B	R	A	G
1994	R	L	Y	S	T	J	U	M	P	B	R	A	G
1995	S	C	K	D	E	L	Y	S	T	J	U	M	P

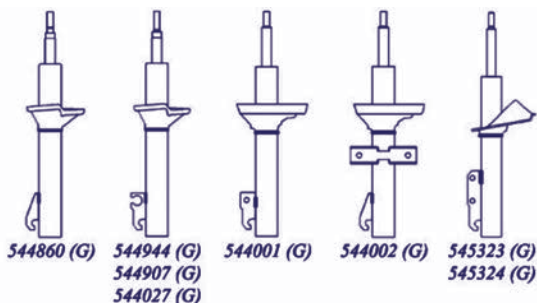

• Escort 4 = Types AAF & ABF & ALF & ANF & AVF  
• Escort 5 & 6 = Types AAL & ABL & AFL & ALL & ANL & AVL

- (5) Poids indiqué en Kg = Charge Utile = poids Total en charge - poids à vide = (F.2) - (G.1) sur Certificat d'Immatriculation  
Mentionned Weight in Kg : s = Payload/Live Weight = Total Laden Weight - Unloaded Weight = (F.2) - (G.1) on Registration certificate
- (6) Sauf véhicules avec système automatique de réglage de niveau / Except vehicles with automatic levelling device
- (7) FORD EUROPE  
FORD FIESTA Avant / Front  
Mois & Année de production : voir 11<sup>ème</sup> & 12<sup>ème</sup> codes du numéro dans la série du type (Numéro d'identification)  
Month & Year of Production : see 11th & 12th digits of the vehicle identification number

Année Year	11 <sup>ème</sup> code 11 <sup>th</sup> digit	Mois = 12 <sup>ème</sup> code / Month = 12 <sup>th</sup> digit											
		01	02	03	04	05	06	07	08	09	10	11	12
1989	K	J	U	M	P	B	R	A	G	C	K	D	E
1993	P	J	U	M	P	B	R	A	G	C	K	D	E
1994	R	L	Y	S	T	J	U	M	P	B	R	A	G
1995	S	C	K	D	E	L	Y	S	T	J	U	M	P
1996	T	B	R	A	G	C	K	D	E	L	Y	S	T
1998	W	L	Y	S	T	J	U	M	P	B	R	A	G
2001	1	J	U	M	P	B	R	A	G	C	K	D	E

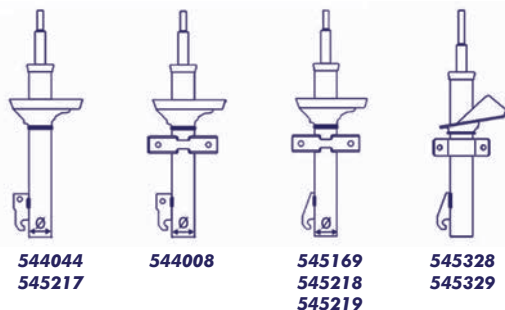

• Fiesta 4 = 01.94 > 08.95 : Types FA & FB & FV  
• Fiesta 4 Classic = 09.95 > 12.96 : Types FA & FB & FV  
• Fiesta 5 = 09.95 > 02.02 : Types JA & JB & JV  
• Fiesta 6 = 03.02 > : Types JD & JH

- (8) FORD FIESTA IV & PUMA : Arrière / Rear: Fixation inférieures / Bottom attachments:

355320 (G) =  
Ferrure en "U" / "U" shaped bracket



355479 (G) =  
Anneau / Loop





## IVECO DAILY (4X2)

(1)	Référence d'origine / Original part N°	Référence SIA'AM	Référence d'origine/ Original part n°	Référence SIA'AM
	4.829.233	204051	4.850.528	214023
	4.829.234	204908	8.574.216	204969
	4.829.235	214052	8.586.273	214994
	4.835.372	214023	8.587.219	204969
	4.835.375	214023	93.803.675	204051
	4.843.748	214994	93.803.892	204051
	4.843.749	214994		

## JAGUAR

- (1) Sauf véhicules avec système automatique de réglage de niveau / Except vehicles with automatic levelling device

## LANCIA

- (1) Pour Jambes de Force non serties / For non-sealed Struts  
 (2) Sauf véhicules avec amortisseurs réglables par système électronique / Except vehicles with electronically adjustable shock absorbers  
 (3) Sauf véhicules avec système automatique de réglage de niveau / Except vehicles with automatic levelling device  
 (4) CITROEN EVASION / FIAT ULYSSE / LANCIA ZETA / PEUGEOT 806 Arrière / Rear

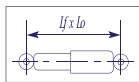

Lf = Longueur Fermée / Closed Length    Lo = Longueur Ouverte / Extended Length  
 Si /If Lf \* Lo = 262 \* 380, alors monter la référence / then fit part number 215245 ou / or 215245G  
 Si / If Lf \* Lo = 290\*408, alors monter la référence / then fit part number 215468 ou / or 215468G

## LAND ROVER (4X4)

- (1) ou / or 834046 Jusqu'à épuisement du stock / while stocks last

## MATRA

- (1) ou / or 144527 Jusqu'à épuisement du stock / while stocks last

## MAZDA

- (1) Sauf véhicules avec amortisseurs réglables par système électronique / Except vehicles with electronically adjustable shock absorbers



## MERCEDES

- (1) Sauf véhicules avec amortisseurs réglables par système électronique / Except vehicles with electronically adjustable shock absorbers
- (2) Sauf véhicules avec système automatique de réglage de niveau / Except vehicles with automatic levelling device
- (3) Amortisseur à l'extérieur du ressort / Shock absorber outside the spring
- (4) Sauf suspension surélevées d'origine / Except originally raised suspensions
- (5) MERCEDES CITAN / RENAULT KANGOO 2: Avant / Front  
 $\varnothing$  Extérieur Tube / Outer Tube External  $\varnothing = 46$  ou/or  $47$  mm  
 545846 / 545846G



- (5)  $\varnothing$  Extérieur Tube / Outer Tube External  $\varnothing = 51$  ou/or  $52$  mm  
 545762 / 545762G



- (6) ATTENTION : Après remplacement des jambes de force; me réglage du train avant est impératif  
 CAUTION: After fitting new front struts, wheel camber angle and steering alignment should always be checked

## MITSUBISHI

- (1) Sauf véhicules avec amortisseurs réglables par système électronique / Except vehicles with electronically adjustable shock absorbers

## NISSAN

- (1) ALMERA Avant / Front : 545357 / 545357(G) (JFG), 545358 / 545358(G) (JFD): (L) = 153 mm  
 ALMERA Arrière / Rear : 355381 / 355381G:  $\varnothing$  Coupelle Appui de ressort / Spring Seat  $\varnothing = 103$  mm
- (2) BLUEBIRD Avant / Front  
 Si / If (L) = 270 mm monter la référence / fit part number 444638  
 Si / If (L) = 280 mm monter la référence / fit part number 444291  
 Si / If (L) = 295 mm monter la référence / fit part number 444179
- (3) Sauf véhicules avec amortisseurs réglables par système électronique / Except vehicles with electronically adjustable shock absorbers
- (4) NISSAN CHERRY: Avant / Front:  
 Livré avec une bague et 2 écrous permettant le montage sur tous les modèles  
 Supplied with a spacer and 2 gland nuts to enable fitting on all models
- (5) Poids indiqué en Kg = Charge Utile = poids Total en charge - poids à vide = (F.2) - (G.1) sur Certificat d'Immatriculation  
 Mentioned Weight in Kg : s = Payload/Live Weight = Total Laden Weight - Unloaded Weight = (F.2) - (G.1) on Registration certificate
- (6) Sauf véhicules avec système automatique de réglage de niveau / Except vehicles with automatic levelling device

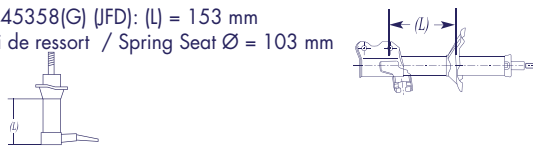

## OPEL

- (1) Sauf véhicules avec amortisseurs réglables par système électronique / Except vehicles with electronically adjustable shock absorbers
- (2) Sauf véhicules avec système automatique de réglage de niveau / Except vehicles with automatic levelling device
- (3) Sauf suspensions surbaissées d'origine / Except originally lowered suspensions
- (4) ou / or 144326 / 144326(G) Jusqu'à l'épuisement du stock / While stocks last



**PEUGEOT**

- (1) 104 Arrière / Rear  
354194 : ENTR'AXE S = 370 \* 560  
354504 : ENTR'AXE S = 375 \* 609

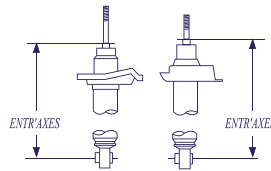

354580/354580G : ENTR'AXE S = 410 \* 581  
354627/354627G : ENTR'AXE S = 410 \* 645

- (2) ou / or 544986 / 544986G Jusqu'à épuisement du stock / While stocks last

- (3) PEUGEOT 207 Avant / Front :  
Ø Tige origine / original piston Rod Ø = 22 mm  
Ø Intérieur pivot / Hyb internal Ø = 51 mm  
545607 / 545607G = Gauche / Left  
545608 / 545608G = Droite / Right



Ø Tige origine / original piston Rod Ø = 20 mm  
Ø Intérieur pivot / Hyb internal = 47 mm  
545771 / 545771G = Gauche / Left  
545772 / 545772G = Droite / Right

- (4) Sauf véhicules avec système automatique de réglage de niveau / Except vehicles with automatic levelling device

- (5) CITROEN C3 phase 2 & DS3 & PEUGEOT 208 Avant / Front:  
Ø Intérieur Pivot / Hyb internal Ø = 47 mm  
545881 / 545881G = Gauche / Left  
545882 / 545882G = Droite / Right



Ø Intérieur Pivot / Hyb internal Ø = 51 mm  
545883 / 545883G = Gauche / Left  
545884 / 545884G = Droite / Right

- (6) ou / or 545165(G) JFG et 545166(G) JFD Jusqu'à épuisement du stock / While stocks last

- (7) Sauf véhicules avec amortisseurs réglables par système électronique / Except vehicles with electronically adjustable shock absorbers

- (8) Si, cas exceptionnel, le véhicule est équipé de ressort plus courts qui ne peuvent être comprimés avec la référence 444444 monter la références 444025 FU / lf, exceptional case, the vehicle is equipped with shorter springs which cannot be compressed with ref 444444, then fit part n°444025

- (9) CITROEN EVASION / FIAT ULYSSE / LANCIA ZETA / PEUGEOT 806 Arrière / Rear  
Lf = Longueur Fermée / Closed Length Lo = Longueur Ouverte / Extended Length  
Si / lf Lf \* Lo = 262 \* 380, alors monter la référence / then fit part number 215245 ou / or 215245G  
Si / lf Lf \* Lo = 290\*408, alors monter la référence / then fit part number 215468 ou / or 215468G

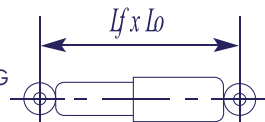

- (10) Poids indiqué en Kg = Charge Utile = poids Total en charge - poids à vide = (F.2) - (G.1) sur Certificat d'Immatriculation  
Mentionned Weight in Kg : s = Payload/Live Weight )= Total Laden Weight - Unloaded Weight = (F.2) - (G.1) on Registration certificate

- (11) Except Camping Car

- (12) CITROEN JUMPER / FIAT DUCATO / PEUGEOT BOXER Arrière / Rear:  
Lf = Longueur Fermée / Closed Length Lo = Longueur Ouverte / Extended Length  
Si / lf Lf \* Lo = 283 \* 418 alors monter / then fit 715861  
Si / lf Lf \* Lo = 293 \* 444 alors monter / then fit 715862  
Si / lf Lf \* Lo = 315 \* 476 alors monter / then fit 715863

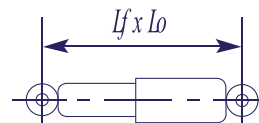

- (13) CITROEN JUMPY / FIAT SCUDO / PEUGEOT EXPERT Arrière / Rear  
Lf = Longueur Fermée / Closed Length Lo = Longueur Ouverte / Extended Length  
Si / lf Lf \* Lo = 262\*380, alors monter la référence / then fit part number 215296 ou / or 215296G  
Si / lf Lf \* Lo = 290\*408, alors monter la référence / then fit part number 215475 ou / or 215475G

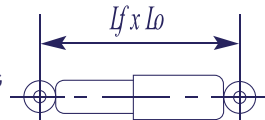

**PORSCHE**

- (1) Seulement pour Jambes de Force BOGE / Only for BOGE Struts



**RENAULT**

(1) RENAULT CLIO I: Avant / Front

*Si ref.origine/If original part n°= 77 00 808 490 - 77 00 816 045 - 77 00 823 130 - 77 00 828 680 - 77 00 838 084, alors monter/then fit 545195G ou/or 545195*

(2) RENAULT CLIO 1: Avant / Front

*Si ref.origine/If original part n°= 77 00 808 491 - 77 00 808 492 - 77 00 816 046 - 77 00 823 129 - 77 00 823 131 - 77 00 828 681 - 77 00 828 682 - 77 00 828 866 - 77 00 830 086 - 77 00 830 087 - 77 00 838 083 - 77 00 838 086 - 77 00 838 087, alors monter/then fit 545196G ou/or 545196*

(3) RENAULT CLIO 1: Avant / Front

*Si ref.origine/If original part n°= 77 00 423 726 - 77 00 423 727 - 77 00 423 729, alors monter/then fit 545365G ou/or 545365*

(4) RENAULT CLIO II: 3 / 5 Portes / Doors - Avant / Front

Si 52 mm alors monter / If 52 mm then if 545366(G)

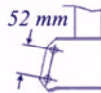

Si 58 mm alors monter / If then fit 545367(G)

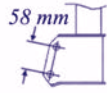

(5) RENAULT CLIO II : 4 Portes / Doors - Avant / Front

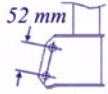

Si réf origine / if original part n° = 7700435333, 7700839378, 8200193013, 8200221816, 8200238826, 8200299816, 8200662265, 8200737472 alors monter / then fit 545366 (G)

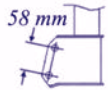

Si réf origine / If original part n° = 7700428438, 7700428602, 7700434925, 7702258372, 8200030741, 8200059508, 8200126408, 8200193016, 8200299817, 8200299822, 8200662261, 8200737473, 8200737475 alors monter / then fit 545367 (G)

(6) Anneau inférieur: Ø Axe ou bague = 10 mm / Lower loop : Ø Sleeve = 10 mm

(7) Sauf véhicules avec système automatique de réglage de niveau / Except vehicles with automatic levelling device

(8) Poids indiqué en Kg = Charge Utile = poids Total en charge - poids à vide = (F.2) - (G.1) sur Certificat d'Immatriculation

Mentionned Weight in Kg : s = Payload/Live Weight = Total Laden Weight - Unloaded Weight = (F.2) - (G.1) on Registration certificate

(9) MERCEDES CITAN / RENAULT KANGOO 2 Avant / Front:

Ø extérieur Tube / Outer Tube external Ø = 46 ou/or 47 mm



545846 / 545846G

Ø extérieur Tube / Outer Tube external Ø = 51 ou/or 52 mm



545762 / 545762G

(10) LAGUNA Avant / Front

545199 / 545199G

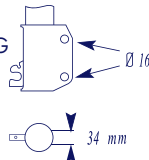

545190 / 545190G

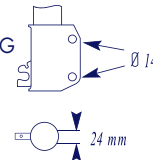

(11) ou / or 545198 / 545198G Jusqu'à épuisement du stock / while stocks last

(12) Si véhicule équipé de Lampes au Xénon, réinitialisation à effectuer / If Xenon light equipped vehicle, re-initialization must be carried out

(13) Sauf véhicules avec amortisseurs réglables par système électronique / Except vehicles with electronically adjustable shock absorbers

(14) SUPER 5 Avant / Front

Si ref origine / If original part n° = 7700731992 - 7700732397 - 7700732743 - 7700732744 - 7700807874 - 7701033884 - 7702745522 - 7702145523 - Alors monter / then fit 544945 ou / or 544945G

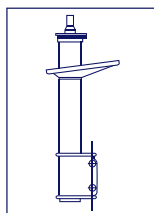

(15) SUPER 5 Avant / Front

Si ref origine / If original part n° = 7700786597 - 7700807873 - 7701034906 - 7702150468 - Alors monter / then fit 544048 ou / or 544048G

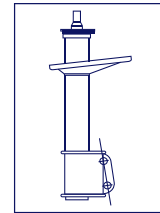



- (16) EXPRESS  
Avant / Front  
544945 ou / or 544945G

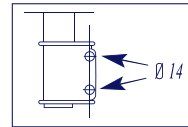
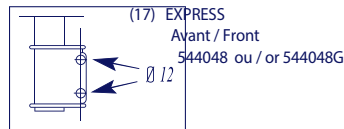

- (18) Si véhicule = Made in Turkey, alors monter la référence 548285 JF / If vehicle = Made in Turkey, then fit part number 5482 85  
(19) Si train arrière avec 2 barres de torsion (type tube), alors monter la réf: 154874 ou 154874G  
If rear suspension with 2 torsion bars (tube type), then fit part n°: 154874 or 154874G



- Si train arrière avec 4 barres de torsion (type tube), alors monter la réf: 154965 ou 154965G  
If rear suspension with 4 torsion bars (tube type), then fit part n°: 154965 or 154965G

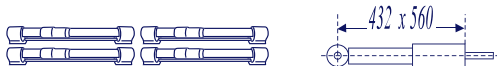

- (20) RENAULT R18

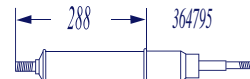
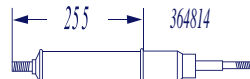
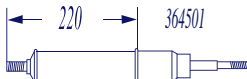

- (21) RENAULT R19 Arrière / Rear  
Si train arrière avec 2 barres de torsion (type tube), alors monter réf: 154030 ou 154030G  
If rear suspension with 2 torsion bars (tube type), then fit part n°: 154030 or 154030G



- Si train arrière avec 4 barres de torsion (type tube), alors monter la réf: 154965 ou 154965G  
If rear suspension with 4 torsion bars (tube type), then fit part n°: 154965 or 154965G

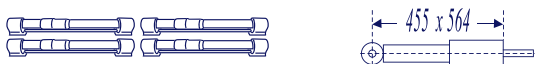

- (22) R20 / R30 Avant / Front



- (23) ATTENTION : Après remplacement des jambes de force ou cartouches, le réglage du train avant est impératif  
CAUTION : After fitting new front struts or inserts, wheel camber angle and steering alignment should always be checked

- (24) RENAULT 21: Pour véhicule avec moteur transversal / For vehicles with transverse engine

- (25) RENAULT 21: Pour véhicule avec moteur longitudinal / For vehicles with line engine

- (26) RENAULT TRAFIC Arrière / Rear

Si / If Lf \* Lo = 340 \* 553, alors monter / then fit 254873

Si / If Lf \* Lo = 354 \* 582, alors monter / then fit 254962

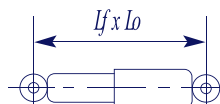





## SEAT

- (1) Sauf véhicules avec système automatique de réglage de niveau / Except vehicles with automatic levelling device
- (2) ATTENTION : Après remplacement des jambes de force, le réglage du train avant est impératif  
CAUTION : After fitting new front struts or inserts, wheel camber angle and steering alignment should always be checked
- (3) ou / or 545241 / 545241G Jusqu'à épuisement du stock / while stocks last
- (4) ou / or 355236 / 355236G Jusqu'à épuisement du stock / while stocks last
- (5) SEAT CORDOBA / IBIZA – Voir le code d'option sur la plaque d'identification / See the option code on the identification plate :  
Standard Suspension = Avant / Front G17 / Arrière / Rear 1JJ  
Sport Suspension = Avant / Front G19 ou / or G21 / Arrière / Rear 1JE ou / or 1JF
- (6) Voir le dernier code d'option sur la plaque d'identification / See the last of option on the identity plate  
Standard Suspension = 1GA, 1GC, 1GE, 1GU, G08, G09, G27, G28, G29, G34, G36, G37, G41, G44, G45, G47, G76, G81 ou / or G82  
Sport Suspension = 1GD, 1GL, 1GT, 1GV, G16, G72, G73, G75, G84, G86, G87, G88 ou / or G99  
Suspension Mauvaises Routes / Rough Roads = 1GB, 1GW, G10, G39, G48, G93 ou / or G95
- (7) Voir le dernier code d'option sur la plaque d'identification / See the last of option on the identity plate  
Standard Suspension = G40, G48 ou / or G49  
Sport Suspension = G50 ou / or G51  
Suspension Mauvaises Routes / Rough Roads = G52, G53, G59, ou / or G60
- (8) Sauf véhicules avec amortisseurs réglables par système électronique / Except vehicles with electronically shock absorbers

## SKODA

- (1) Sauf véhicules avec système automatique de réglage de niveau / Except vehicles with automatic levelling device
- (2) SKODA OCTAVIA 2 = 06.05 > 12.12 & VOLKSWAGEN GOLF 5 = 11.03 > 09.08 / GOLF 6 = 10.08 > 08.12  
Voir le dernier code d'option sur la plaque d'identification / See the last of option on the identity plate  
Standard Suspension = 2UA  
Sport Suspension = 2UC  
Suspension Mauvaises Routes / Rough Roads = 2UB  
Adaptive Suspension = G01 ou/or G03
- (3) Sauf véhicules avec amortisseurs réglables par système électronique / Except vehicles with electronically shock absorber

## SUBARU

- (1) Sauf véhicules avec système automatique de réglage de niveau / Except vehicles with automatic levelling device

## SUNBEAM

- (1) Pour le montage, utiliser la ferrure supérieure d'origine / On fitting, use original upper bracket

## TALBOT FRANCE

- (1) ou / or 144527 Jusqu'à épuisement du stock / while stocks last
- (2) Poids indiqué en Kg = Charge Utile = poids Total en charge - poids à vide = (F.2) - (G.1) sur Certificat d'Immatriculation  
Mentionned Weight in Kg : s = Payload/Live Weight ]= Total Laden Weight - Unloaded Weight = (F.2) - (G.1) on Registration certificate

## TOYOTA

- (1) Sauf véhicules avec amortisseurs réglables par système électronique / Except vehicles with electronically shock absorbers
- (2) Jambes de force non serties / For non-sealed Struts
- (3) Sauf véhicules avec système automatique de réglage de niveau / Except vehicles with automatic levelling device



## VAUXHALL

- (1) Sauf véhicules avec système automatique de réglage de niveau / Except vehicles with automatic levelling device
- (2) Sauf véhicules avec amortisseurs réglables par système électronique / Except vehicles with electronically shock absorbers
- (3) ou / or 144326 / 144326G Jusqu'à épuisement du stock / while stocks last

## VOLKSWAGEN

- (1) Voir le dernier code d'option sur la plaque d'identification / See the last of option on the identity plate  
Standard Suspension = 1GA, 1GC, 1GE, 1GU, G08, G09, G27, G28, G29, G34, G36, G37, G41, G44, G45, G47, G76, G81 ou / or G82  
Sport Suspension = 1GD, 1GL, 1GT, 1GV, G16, G72, G73, G75, G84, G86, G87, G88 ou / or G99  
Suspension Mauvaises Routes / Rough Roads = 1GB, 1GW, G10, G39, G48, G93 ou / or G95
- (2) ATTENTION : Après remplacement des jambes de force, le réglage du train avant est impératif  
CAUTION : After fitting new front struts or inserts, wheel camber angle and steering alignment should always be checked
- (3) ou / or 444670 / 444670G Jusqu'à épuisement du stock / while stocks last
- (4) SKODA OCTAVIA 2 06.05 > 12.12 & VOLKSWAGEN GOLF 5 = 11.03 > 09.08 / GOLF 6 = 10.08 > 08.12  
Voir le dernier code d'option sur la plaque d'identification / See the last of option on the identity plate  
Standard Suspension = 2UA  
Sport Suspension = 2UC  
Suspension Mauvaises Routes / Rough Roads = 2UB  
Adaptive Suspension = G01 ou/or G03
- (5) Sauf véhicules avec amortisseurs réglables par système électronique / Except vehicles with electronically shock absorbers
- (6) ou / or 545241 / 545241G Jusqu'à épuisement du stock / while stocks last
- (7) Sauf véhicules avec système automatique de réglage de niveau / Except vehicles with automatic levelling device
- (8) Voir les repères de couleur sur les ressorts hélicoïdaux et la plaque d'identification du véhicule située dans le coffre à bagages sous la garniture du plancher :  
See the coloured marks on the coils springs and th vehicle identification plate located in the luggage boot under the floor trim :
 

Suspension:	Repères de Couleur / Coloured Marks:	Plaque d'identification/Identification Plate:
Standard	1 Argent / Silver + 1 Vert /Green	Option = 1BA
Sport	1 Argent / Silver + 2 Blanc / White	Option = 1BE
Suspension Pneumatique / Pneumatic		Option = 1BY
Suspension Mauvaises Routes / Rough Roads		
- (9) VOLKSWAGEN PASSAT 5 / 6: Voir le code d'option sur la plaque d'identification / See the option code on the identification plate:
 

PASSAT 5:	PASSAT 6:
Standard Suspension = 1BA	Standard Suspension = G07
Sport Suspension = 1BE	Sport Suspension = G08
Suspension Mauvaise Routes /	Suspension Mauvaise Routes /
Rough Roads = 1BB ou / or 1BP	Rough Roads = G09 ou / or G28»
- (10) VOLKSWAGEN PASSAT 7: Voir le dernier code d'option sur l'étiquette d'identification / See the last option code on the identification label:  
Chassis Standard = G2, G07, G11, G12 ou / or G15      Chassis Sport: G03, G08, G23 ou / or G28  
Chassis Surbaissé / Lowered = G37 ou / or G38      Chassis Mauvaises Routes / Rough Roads = G04, G05, G09, G10 ou / or G16»
- (11) ou / or 355236 / 355236G Jusqu'à épuisement du stock / while stocks last
- (12) VOLKSWAGEN POLO 4:  
Voir le dernier code d'option sur l'étiquette d'identification / See the last option code on the identification label:  
Chassis Standard = G01, G09, G10 ou / or G13  
Chassis Sport: G12, G22 ou / or G27  
Chassis Mauvaises Routes / Rough Roads = G13, G14, G33 ou / or G34

## VOLVO

- (1) Sauf véhicules avec système automatique de réglage de niveau / Except vehicles with automatic levelling device
- (2) VOLVO 240, 260 Avant / Front: Sauf si cartouches d'origine à gaz / Except if original gas inserts
- (3) Sauf véhicules avec amortisseurs réglables par système électronique / Except vehicles with electronically shock absorbers



---

# **TABLE DES CORRESPONDANCES OEM OEM CORRESPONDENCE**

---

SIAAM	OEM	PAGE
101125(G)	–	197
101130(G)	–	162
101151(G)	–	58
101153(G)	–	58
101162(G)	5350857 5350875 5351215	264, 285
101333(G)	111 413 031 B 111 413 031 F 111 413 031 G	
101334(G)	111 413 031 B 111 413 031 F 111 413 031 G	265, 266
101404(G)	311 413 031 A 311 413 031 E 311 413 031 F	266
101468(G)	276440 5304024 89543	284
101475(G)	7872401 8910457 891877	224
101495(G)	–	34, 35, 101, 102, 138, 286
101507(G)	–	285
101508(G)	–	60
101511(G)	–	56
101512(G)	–	56
101623(G)	548077	224
101641(G)	1851599000 1851600004	65, 284, 285
101748(G)	–	264
101766(G)	–	112
101803(G)	–	264, 265
101808(G)	311 413 031 A 311 413 031 E 311 413 031 F	282
101828(G)	7872401 8910457 891877	224, 225
101861(G)	–	95
101871(G)	GDA1042 8822380	105, 262, 263, 264, 265
101887(G)	–	109
101922(G)	–	240
101993(G)	6 019 251 6 020 127 6 020 129	81, 94
104158(G)	211 413 031 B 211 413 031 P 211 413 031 Q	282
104534(G)	48510-87603 48511-87603	64, 65, 99, 102, 241
104689(G)	8855 91018422	264

SIAAM	OEM	PAGE
104770(G)	C5TA18097A3 C5TA18097C3 C8TZ18125B	105, 198, 285
104789(G)	A 601 320 00 30 A 601 320 01 30 A 601 320 07 30	130
104992(G)	56110G2525 56110G2527 56110G2528	148
105128(G)	MB338897 MB338899 MB339474	65, 133, 137, 147, 184
105137(G)	AAR3678 AAR4121	64, 98
105139(G)	56110-11C29 56110-16C26	148
105147(G)	–	138
111152(G)	–	58
111163(G)	5350755 5353217 5354897	285
111342(G)	GDA1011 NA64054158KAJR	259, 260
111366(G)	5355684 5361745 5900628	68, 69, 98, 99, 100, 234
111426(G)	–	49
111496(G)	–	69, 184
111528(G)	–	138
111553(G)	–	109, 110
111700(G)	211 513 031 G 211 513 031 I 211 513 031 J	282
111767(G)	–	112
111780(G)	6 028 347	82, 83
111807(G)	–	35
111867(G)	2101-291 5402 2121-291 5402 2121-291 5402-04	66, 107, 225
111868(G)	–	259
111908(G)	113 513 031 A 113 513 031 C 113 513 031 N	265, 266
111919(G)	6028347	83
111955(G)	56210K3000 56210K3025 56210K3026	139, 149, 252
111994(G)	1 521 578 1 521 579 6 009 955	81, 94, 95, 101
114000(G)	RPD10042	34
114007(G)	5031030 5031031 6 180 900	85, 86, 87
114029(G)	1329501 1330702	284

SIAAM	OEM	PAGE
114036(G)	J4853139925 485310B050 8942231641	103
114038(G)	6025 000 247 6025 002 569 6025 003 539	195, 196
114050(G)	436 585 436 586	35, 153, 154, 156, 261, 262
114054(G)	7700 411 047 7700 427 536 7700 802 607	187, 188, 189, 190, 191, 192
114059(G)	60500393 7619437	17, 69, 79, 109
114104(G)	1212110 675210P3 679599	283
114122(G)	–	110
114159(G)	211 513 031 Q 211 513 031 R	282
114242(G)	331 513 031 A 331 513 031 B 331 513 031 C	19, 276
114288(G)	–	112, 244
114381(G)	2D0513029 6013200431 9013200631	98, 129, 130
114395(G)	1205916 1206641 1272126	283
114429(G)	7210-22010 7210-22060 7210-2232	240
114473(G)	19 58 333 48531-35180 48531-39475	255
114487(G)	–	257
114517(G)	8131-99-281 8134-99-281 8531-28-700	113, 114
114520(G)	MB002704 MT141622 41700-52010	100, 132, 135, 136
114531(G)	–	133
114532(G)	MB003011 MB003012	133
114535(G)	4851029276 4853123040 4853180024	133, 249, 251, 256, 258
114536(G)	436096 436099 436109	257
114593(G)	2101-291 5402 2121-291 5402 2121-291 5402-04	
114703(G)	S085-99-281	116, 117, 132
114741(G)	477 513 031 A	184, 185

SIAAM	OEM	PAGE
114780(G)	A 601 320 04 31 A 601 320 06 31 A 601 320 08 31	130
114781(G)	C5TA18097A3 C5TA18097C3 C5TZ18125B	105, 198, 285
114786(G)	56119-32201 56210-G1000 56210-G1025	64, 133, 134, 135, 136, 146, 147, 148
114801(G)	6 136 718 6 136 719 6 136 721	94
114802(G)	147 513 031 147 513 031 A	83, 84, 267, 273
114829(G)	3916661 4325567 4354989	67, 225, 226
114864(G)	MB110446 MB110447 MB110448	100, 101, 132, 136, 137
114879(G)	MB110975 MB110976 MB111226	133, 134, 138
114917(G)	MB110710 MB110711	136
114942(G)	5206.L3 5206.37 5206.43	58, 59, 60, 166, 173, 174, 175
114946(G)	7700 729 342 7700 729 343 7700 788 547	207
114970(G)	5967923 7600789 7720252	35, 74, 110
114972(G)	96 032 731 96 032 733 96 056 928	51
114980(G)	6006 003 789 7700 733 849 7702 146 638	208
114984(G)	7700734439 7700734445 7700761431	216
115024(G)	5001833 5001834 5001835	134
115125(G)	91117678	262
115126(G)	56210-M9000 56210-M9025	141
115136(G)	MB242817 MB242818 MB515097	132, 137
115150(G)	00005206F7 00005206F8 5206F7	
115170(G)	46437781 7705508	70, 78

SIAAM	OEM	PAGE
115182(G)	5000389987 5000390185 6006000215	201, 202
115191(G)	7719070 7789196 46452194	75
115200(G)	6K9 513 031 A 6K9 513 031 B	229, 267, 280
115222(G)	1 133 935 5 030 477 92 FX-18K076-AG	81, 82
115257(G)	71712480 7753419	35, 110
115262(G)	3344284 3445924 3445925	283
115264(G)	1019331 6 536 460 6 536 461	86, 87
115286(G)	46425450 46452194 46472963	110
115290(G)	7700410586 7700273478 7700415822	203, 204
115327(G)	1011947 1011951 1019334	87
115332(G)	7700410587 7700414158 7700432051	204
115337(G)	7M0 513 031 D 7M0 513 031 F 7M0 513 031 H	90, 226, 281
115364(G)	48531-27100 48531-27110 48531-80078	257, 260
115378(G)	46463793 46463795	73, 74
115408(G)	46545255 46545256 46738204	76
115437(G)	7,700,410,586	203, 204
115439(G)	5621 000 QAJ 7700 308 590 8200 029 306	142, 198
115463(G)	56200-35G00 56200-35G10 56200-35G25	140
115474(G)	41800-50A00 41800-50E10 41800-51A00	243
115498(G)	46545255 46545256 46738204	75, 76
115510(G)	6383260700 6383261200	129, 132

SIAAM	OEM	PAGE
115512(G)	1087963 1087964	90
115526(G)	4170077A00 4170081A00 4170081A01	241
115534(G)	72 119 052 72 119 053 72 119 073	151, 152
115535(G)	436 284 72 119 054 72 119 055	151, 152, 161
115539(G)	A 168 320 00 31 A 168 320 02 31 A 168 320 04 31	124
115555(G)	72 119 059 72 119 125 93 177 217	161
115590(G)	50703689	73, 110, 111
115592(G)	5206AN 5207X7 5206Z7	52, 180
115606(G)	562005X02A E6200EB70C	143
115619(G)	-	95, 97
115627(G)	72119125 72119126 436188	153, 154, 156
115631(G)	82 00 108 182 82 00 108 183 82 00 283 391	200
115656(G)	50703135	78
115660(G)	7H0513029F	282
115665(G)	4700500 9193868 4180083E11	150, 241, 243
115684(G)	1575022	90
115685(G)	51780319	70, 159, 160, 161
115693(G)	51856394 51857282 51857284	75
115700(G)	1C15-18080 KD 4346323	96
115709(G)	4106062 4346323 1C1518080BD	96
115718(G)	6393260300 6393260800 6393260900	132
115743(G)	0445021-0 44050210 56100G4800	148
115746(G)	50708786 50708787 50709081	68, 91
115749(G)	50705349 50705457 50707774	

SIAAM	OEM	PAGE
115752(G)	5206RG 51821089 51830534	57, 73, 76, 180
115758(G)	2K0513029B 2K0513029F 2K0513029G	267, 268
115769(G)	55310-02000 55310-02110	100
115778(G)	414 3200131 4143260600 4143260700	131
115811(G)	1C1518080AD 4092422 4141760	96, 97
115812(G)	1C1518080KB 1C1518080KC 4346323	96
115845(G)	51846485 51925898 51955345	75
115850(G)	1341063 1348869 1363150	90
115905(G)	553000X000 553000X100 553000X200	101
115916(G)	–	55, 170
115919(G)	55300-1M000 55300-1M300	
115931(G)	6C1118080RA 6C1118080VA 6C1118080WB	97
115933(G)	1371349 1371350 1371351	97
118129(G)	–	103
118668(G)	S28028700 S24A28700A S09199281	93, 117
121572(G)	4105252 4112067 4130644	35, 67, 68, 226
131126(G)	0855 476 900 0855 813 500 0982 371 800	205, 206, 207, 208
131319(G)	–	65, 66
131499(G)	–	65
131526(G)	–	63, 64
131573(G)	4112025 4112940 4114025	35, 67, 68, 226
131678(G)	7700515541 7700511045 7700515543	206, 207, 208
134182(G)	61086011 70052807DGH48 GSA379	138

SIAAM	OEM	PAGE
134652(G)	22 012 512 436 050 436 490	35, 151, 155, 156, 260
141004(G)	8 939 665 9 003 115 90 094 795	153, 158
141080(G)	0855 791 200 0982 371 000 0982 371 900	206, 207, 208
141112(G)	–	112, 113, 194, 197
141114(G)	7700527394 7701400129 9823695	60, 197, 208, 209
141116(G)	–	195, 197
141118(G)	–	19, 112, 113, 209
141122(G)	–	185
141125(G)	0855791200 0866791300 0982371900	205, 206, 207, 208
141134(G)	–	234
141319(G)	–	65, 66
141388(G)	–	68, 69
141408(G)	0060710170 102002107002 105002107003	18
141425(G)	–	49
141496(G)	8-94124-547-0 8-94226-944-0 94124547	69, 184, 286
141498(G)	–	65
141518(G)	–	94
141527(G)	–	138
141529(G)	–	265
141530(G)	342009 342094 342108	155, 158
141537(G)	–	102
141551(G)	–	109, 110
141559(G)	111495000 113495000 114495000	235, 236
141561(G)	–	99, 100, 234, 241
141586(G)	–	149
141587(G)	–	65
141592(G)	–	241
141600(G)	–	19, 20, 21
141601(G)	5980866 5980867 1562 02 00	66, 67, 69, 183, 184, 226
141615(G)	AT719775	260
141627(G)	113 413 031 D 113 413 031 E 113 413 031 K	265

SIAAM	OEM	PAGE
141628(G)	4425914 4434926 4 140 276	66, 225
141664(G)	–	150, 154, 156
141668(G)	1212389 688252 273354	283
141676(G)	22 012 306 3 469 699 342 010	103, 153, 158
141697(G)	A 111 323 18 00 A 111 323 19 00 A 111 323 20 00	118, 119, 120, 121, 123
141706(G)	13105137 13129998 13181988	153, 155, 158, 262, 285
141751(G)	–	99
141761(G)	09277377 09277417 09277433	140, 145, 249, 250, 251, 256, 258
141773(G)	–	264
141806(G)	4044425 4317672 4330104	35
141822(G)	CAC9089 C27795	65, 105
141839(G)	–	116
141884(G)	A 107 320 00 30 A 107 320 01 30 A 107 323 00 00	118, 119, 120, 121, 122, 123, 124
141910(G)	A 111 323 19 00 A 111 323 20 00 A 111 323 21 00	121
141926(G)	–	264
141961(G)	3 443 777 3 455 266 342 160	150, 156
141980(G)	0855947700 0982372700 0982373200	211
144034(G)	5001804 4853129205 4853129175	259
144072(G)	4850029225 4851130090 4851130100	281
144083(G)	8942269710 94226971 9226971	36, 103, 135, 156
144134(G)	0060730502 0060731967 116002107001	17, 18
144259(G)	1204006798 1204006799 12410700	107
144260(G)	A 123 320 01 30 A 123 320 03 30 A 123 323 18 00	119, 120, 121, 122, 123, 124

SIAAM	OEM	PAGE
144287(G)	GDA1174 0004594200 06330001	112, 244
144345(G)	105002107008 102002107002 105002107003	49, 113, 233, 241, 244
144357(G)	342194 342195 344203	116
144385(G)	22 012 246 22 012 262 22 012 508	103, 150, 155, 156, 261, 262
144413(G)	34004 90094151 09293984	155
144472(G)	MB573600 MB573601 MB573602	255, 256
144592(G)	2121290540201 2121290540202 2121290540204	107
144653(G)	8939373 8939381 8939407	225
144702(G)	342 192 342 193 342 194	116, 117
144727(G)	–	140, 141
144756(G)	48500-0B020 48500-0B030 48500-0B030A	257
144850(G)	56110-01W00 56110-01W25 56110-01W26	36, 102, 103, 140
144870(G)	GSA418 GSA419 GSA435	34, 224
144956(G)	0060530037 113212107201 117012107001	17, 18
145022(G)	–	93, 116
145023(G)	MR267700	134
145127(G)	S31F34700	106, 117
145146(G)	–	64, 98
145148(G)	48510-87606 48510-87608 48510-87680	64, 65
145177(G)	–	245
145185(G)	–	113, 244
145208(G)	–	65
145300(G)	A2103200230 A2103200330 A2103200930	126, 127, 128, 129
145308(G)	A2023201430 A2023202030 A2023202330	125



SIAAM	OEM	PAGE
145462(G)	56110-31G25 56110-35G00 56110-35G25	140
145525(G)	41600-81A10 41600-81A11	241
145583(G)	–	185, 203
145694(G)	A 210 320 30 30 A 210 320 31 30 A 210 323 23 00	126, 127, 128, 129
148128(G)	8944463731	103
148220(G)	89443368871	103
151014(G)	436 056 436 500 9 004 179	150, 154, 156, 157, 158, 263
151040(G)	90 020 090 90 023 292 90 094 156	150, 156, 158
151055(G)	5-51630-005-0 5-51630-023-0 9-51630-261-0	139, 142, 145, 149
151070(G)	1518881 1518884 1529728	81, 90
151110(G)	–	195, 197
151121(G)	0855554100 0855554200 0855571300	19, 194, 195, 197, 208, 209
151123(G)	–	185
151137(G)	–	162
151149(G)	0546238 0710128 11438729	94
151158(G)	–	233
151372(G)	–	18
151469(G)	62157 2887441 3451906	284
151477(G)	4170073010 56210H2502 4170070210	147, 241
151495(G)	GSA130 GSA389	34, 101, 102, 138, 286
151520(G)	–	265
151525(G)	4004700000 4160063010 4160063011	
151539(G)	–	234
151541(G)	–	155
151558(G)	–	98, 234, 241
151585(G)	–	94
151588(G)	–	19, 20, 21, 65
151593(G)	–	241
151602(G)	4165526 4180866 4210605	66, 184

SIAAM	OEM	PAGE
151629(G)	15660201 40827100320 41399661	66, 225
151661(G)	–	259
151685(G)	1 101 304 1 103 170 1 103 628	46
151696(G)	–	138
151722(G)	54227948H0 54227948K7 54299248K3	49, 233, 243, 244
151742(G)	113E18080D 3004E1808000 AR69BB18080AB	81
151743(G)	–	60, 195, 208, 209
151762(G)	5516300350 436051 48531112090	68, 69, 139, 149, 184, 247, 249, 250, 251, 286
151801(G)	5932564 5932565 4 182 262	66, 67, 69, 184, 225, 286
151804(G)	–	246
151844(G)	–	264
151863(G)	1438650 1443983 1451442	80
151872(G)	90290478 436440 436479	105, 262, 263, 264, 265
151917(G)	–	21
151976(G)	–	63
151991(G)	7700515630 7700517630 7700527477	211
151992(G)	–	264, 265
151996(G)	–	265
151999(G)	–	49, 98, 99, 100, 241
154009(G)	GSA2048 NAM6099	34
154026(G)	0060537123 542023	17
154030(G)	7700789511 7700825484	215
154041(G)	7700792617 7700793074	215, 216
154110(G)	4425924 4434940 5920275	67, 226
154130(G)	48531-87184 48531-87185 48531-12200	64, 245, 246, 247, 248, 250, 258
154211(G)	125256 510662 510806	17

SIAAM	OEM	PAGE
154286(G)	56210-M7001 56210-M7025 56210-M7026	141
154297(G)	5611932201 56210H8500 56210H8501	146, 147
154327(G)	22 012 265 3 455 171 436 042	103, 153, 155, 158, 261, 262, 264
154334(G)	48531-19033 56210-N5000 56210-N5025	64, 145, 246, 247
154344(G)	A 750X-18080-AA A 750X-18080-BA 1 438 650	83
154346(G)	48531-16100 48531-16101 48531-80010	49, 241, 244
154354(G)	71248021 206725 GDA1069	98, 241, 244, 245, 246, 247, 248, 250, 251, 252, 258
154356(G)	086628700B 86228700	115, 117
154489(G)	90 023 292 90 094 156 90 094 157	150, 156, 261, 264
154528(G)	00 13 526 700 00 13 533 500 00 13 573 300	113, 233, 244
154589(G)	48531-19715 48531-19825 48531-19845	250, 251, 252
154607(G)	8173-28-700 8173-99-281 48531-12340	115, 116
154611(G)	-	146
154612(G)	436 304 436 307 436 369	146, 148, 247
154651(G)	22 012 278 22 012 317 22 045 604	150, 155, 156, 260, 261
154654(G)	8939399 8939456 8939548	224, 225
154655(G)	GSA389 GSA71116 GSA971389	102
154664(G)	48531-10161 48531-10163 48531-10180	258
154680(G)	-	264
154686(G)	08431 08517 092095A30	49, 98, 241, 244

SIAAM	OEM	PAGE
154688(G)	GSA130 GSA389 M08191	35
154696(G)	D00128700B D00128700C D00128700F	113, 118
154713(G)	56210-H8500 56210-H8501 56210-H8525	147
154755(G)	56210-N8200 56210-N8225 56210-N8226	145, 149
154759(G)	FA01-28-700 FA24-99-281 8871-28-700	118
154777(G)	7700 531 439 7700 535 291 7700 661 562	207
154791(G)	5989060	183, 184
154859(G)	48531-16030 48531-19535 48531-19625	258
154874(G)	7700 677 652 7700 696 304 7700 700 912	209, 210
154876(G)	-	140
154922(G)	-	62
154925(G)	1091629 33521091629 1091999	37, 38
154933(G)	A 124 320 00 31 A 124 320 02 31 A 124 320 04 31	118, 119, 120, 121, 122, 123, 125, 126, 127, 128
154935(G)	436 578 9 004 295 9 004 296	153, 154, 262, 263
154955(G)	5951866 5972898 5976848	80
154965(G)	7700 731 324 7700 731 325 7700 732 138	
155120(G)	436 057 436 561 9 004 325	158, 261
155129(G)	56210-02A25 56210-02A50 56210-02A51	18, 141, 147
155130(G)	56210-16C00 56210-16C25 56210-16C26	148
155131(G)	90 271 098 90 271 102 90 297 923	158, 159, 261, 262, 263
155132(G)	5 008 929 5 008 931 5 016 782	94

SIAAM	OEM	PAGE
155149(G)	72 118 762 72 118 763 72 118 772	62, 63, 150, 151, 156, 159, 260, 261, 262
155158(G)	436 580 9 004 365 90 297 719	151, 260
155181(G)	436 023 90 343 194	152, 261
155186(G)	33 52 1 090 826 33 52 1 090 830 33 52 1 092 309	38
155192(G)	56210-4F125	143
155207(G)	4170056B00	242, 243
155259(G)	41700-56B00 41700-60A00 41700-60A01	242, 243
155275(G)	1J0 512 011 AA 1J0 513 025 AQ 1J0 513 025 AR	23, 229, 232, 237, 266, 270
155309(G)	2033200031 2033200131 2033200156	125
155313(G)	4853142051 4853142052 4853149125	257
155363(G)	7700 426 693 7700 435 335 7700 436 107	193
155373(G)	3B0 513 031 P 3B5 513 031 A 3B5 513 031 B	31, 32, 33, 239, 277, 278
155404(G)	1 090 826 1 090 830 1 092 309	39, 40
155411(G)	2103200031 2103200531 2103200631	126, 127, 128
155450(G)	8200 193 017 8200 287 736 8200 299 818	193
155464(G)	1J0 513 025 AA 1J0 513 025 BM	23, 229, 232, 237, 266, 270
155467(G)	6E0 513 025 A 6X0 513 025 B	227, 276
155502(G)	6Q0513025AH 6Q0513031AH 6R0513025AH	23, 235, 236, 280
155503(G)	6Q0 513 025 AG 6R0 513 025 H 6Q0 513 025 AD	23, 235, 236, 280
155504(G)	1J9 513 025 A	237, 239, 267, 274
155511(G)	1078726 1087966 98 AG-18080-MS	90

SIAAM	OEM	PAGE
155523(G)	48530-0D080 48530-0D100 48530-0D110	259
155524(G)	48530-52100 48530-52102 48530-52140	259
155560(G)	436 180 436 305	154
155564(G)	8Z0 513 025 J	23, 269
155567(G)	6Q0512011P 6Q0513025R	22, 23, 228, 229, 235, 236, 280, 281
155571(G)	436 181 436 306	154
155605(G)	55700452 93189035 93189036	73, 76, 154
155620(G)	33 52 1 091 274 33 52 1 092 309 33 52 1 092 489	39, 40, 41, 42
155625(G)	51831651 51841201	70, 78, 109
155630(G)	1 096 366 2 282 099 33 52 1 091 246	40, 41, 42
155636(G)	E6210-AX602 E6210-BC60A 56210-AX627	143
155643(G)	1209075 2S61-18008-AA 2S61-18008-AB	89, 90, 113
155647(G)	8E0 513 033 8E0 513 033 B	28, 30, 228
155648(G)	8E0 513 033 G 8E0 513 033 H	28, 30
155649(G)	8E0513033J	28, 30
155662(G)	2N1118008AA 2N1118008AB 2N1118008AC	90
155669(G)	8200216799E 8200528607B 8200216799D 8200216799E	61, 62
155673(G)	1318134 1318907 1325091	80, 90
155683(G)	B33A28910A BP4K28910D BP4K28910E	113
155686(G)	4170056B00 4170060A00 4170060A01	243
155687(G)	4853052370 4853059435	259
155695(G)	-	126, 127, 128

SIAAM	OEM	PAGE
155698(G)	5206EG 5206EE 48530-0H010	51, 52, 164, 245
155707(G)	DF71-28-70XB BE8Z-1812-5A D2BZ-1812-5B	89, 113
155712(G)	562109412R 8200368122 8200661700	223
155715(G)	4708275 93193098	150, 242
155740(G)	169 326 0000 169 326 0700	125
155760(G)	553101C200 553101C500	100
155768(G)	48530-52B00 48530-80283 48530-80351 48530-80384	259
155773(G)	6001549248 8200417472 104662	61, 107
155781(G)	71742683 71747484 4180079J00	78, 242
155791(G)	50508841 50516724 50521023	18
155814(G)	562105043R	61
155849(G)	96408735 96410116 96494605	48, 62
155854(G)	55310-07100 55310-07200 553001Y100	106
155866(G)	436528 436530 436543	48, 152
155874(G)	562104719R	62
155875(G)	1S0513025C 1S0513025D	283
155893(G)	562107788R	61, 62, 194, 220
155904(G)	485300D570 485300D580B 485300D660A	258, 259
155907 (G)	562109123R	62
155963(G)	–	149
161141(G)	–	97, 234
161163(G)	–	234
161320(G)	–	264
161330(G)	–	152, 157, 158
161350(G)	4048307 4330103 4361394	35, 66, 68, 184
161371(G)	–	18
161403(G)	–	264

SIAAM	OEM	PAGE
161404(G)	276479	284
161460(G)	1210322 276552 ATS27447E	284
161521(G)	–	264
161544(G)	–	68, 286
164350(G)	018728700 5611044025 5611046525	115
171119(G)	–	197
171120(G)	–	197
171135(G)	–	234
171142(G)	–	97
171150(G)	–	49, 233
171164(G)	–	234
171327(G)	–	264
171361(G)	4044425 4317672 4330104	35, 66, 68, 184
171363(G)	62197 NFP64054138HADT 276553	284
171386(G)	–	68, 226, 286
171408(G)	–	18
171471(G)	0187-28-700 8565-28-700 8565-99-281	284
171522(G)	–	264
171536(G)	–	264
171562(G)	–	101
171619(G)	621160 624540	259, 260
171624(G)	545534	224
171632(G)	–	149
171636(G)	0060701321 101202507001 105142507001	18
171667(G)	–	94
171703(G)	–	68
171749(G)	–	264
171829(G)	8910465 891878 893126	225, 235
174135(G)	0060730537 116002507006 116002507007	18
174185(G)	7700 520 198 7700 520 200 7700 521 878	61, 210, 211
174320(G)	–	141
174358(G)	3874-28-700 56110-31-400 56110-31-425	116, 235

SIAAM	OEM	PAGE
174362(G)	4203-6431 48530-87304 48530-87306	115, 118
174393(G)	227444	63, 64, 283
174502(G)	7700 656 438 7700 676 451 7700 686 595	61, 197, 211, 212, 213, 214
174668(G)	200538 201758 3201758	283
174678(G)	–	260
174750(G)	4203-6431 48530-87304 48530-87306	116, 117
174762(G)	0187-28-700 8565-28-700 8565-99-281	114, 115
174848(G)	–	201, 202
174957(G)	0060533045 117012507002 162002507202	17, 18
175354(G)	5000393469 5000393763 5000394656	201, 202
201043(G)	1 499 291 1 502 211 6 059 133	95, 96
201092(G)	–	98, 129, 130
201478(G)	GSA196	111, 112
201498(G)	–	130
201545(G)	371124MAB 5401557 5491174Z	50, 51
201688(G)	–	104
201781(G)	0013265700 0013268800 0023239400	130, 131
201800(G)	–	68
201891(G)	–	112
201896(G)	–	56
204021(G)	6113200330 6113200430 6113200830	130
204051(G)	4829233 93803675 93803892	70, 71, 104
204192(G)	6025793 72GB18077J3A 72GB18077F3B	81, 90, 94, 95, 101
204213(G)	–	19
204364(G)	3BF 541 51 32 3BF 954 92 681 5415132	55, 68
204478(G)	3AS5440691 5440690 5440691	50, 51

SIAAM	OEM	PAGE
204552(G)	48531-36030 48531-36050 48531-36070	246, 253, 256
204587(G)	A 942 890 11 19 A 942 890 35 19 A 943 890 05 19	36, 101, 102, 116, 117, 140, 246, 250, 251, 253, 254, 255, 257, 258
204891(G)	C5TA18097A3 C5TA18097C3 C5TZ18125B	198, 285
204908(G)	4829234 93826662	71, 104
204969(G)	8574216 8587219	71, 104
205119(G)	AAR 1432 AAR 2550	98
205151(G)	AAR6394	64
205171(G)	6313201330 6313201630 A6313201330	131
205355(G)	–	260
205461(G)	45 00 240 91 60 540 45 00 240	141, 157, 202
205585(G)	91 60 540 45 00 240 7700 310 737	157, 202
211012(G)	–	152
211044(G)	A 740X-18080-NDA 1 499 254 1 499 256	95, 96
211093(G)	–	
211096(G)	5205.75 5205.94	178
211430(G)	–	102, 111
211501(G)	3AYAYB436905A 3AA5422533 95494099	50
211565(G)	–	176
211765(G)	4853135270 4853135280 4853135600	140, 141, 252, 253, 255, 256, 284
211862(G)	4295628 8942265831 8944265830	95
211897(G)	–	56
211911(G)	–	68
211981(G)	–	56
214006(G)	56210-0F605 56210-0F606 56210-0F607	91, 144, 148
214010(G)	4637103 52087777AF 52087948AF	105, 198, 285

SIAAM	OEM	PAGE
214015(G)	5206.G4 5206.R0 5206.83	51
214023(G)	4835372 4835373 4835375 4850528	71, 104
214031(G)	5206.65 5206.66 5206.67	177
214052(G)	4829235	70, 71, 104
214055(G)	7700 802 607 7700 802 609 7700 822 620	185, 186, 187, 188, 189, 190, 191, 192
214057(G)	951.333.032.02 951.333.032.03 951.333.032.05	185
214064(G)	56210-G9801 56210-G9805 56210-G9825	144
214070(G)	MR151229	36, 103, 134, 156
214074(G)	4853135190 4853139675 4853160100	255, 256, 281
214076(G)	–	255, 282
214082(G)	MB111214 MR151235	133, 134
214086(G)	–	135
214218(G)	–	252, 253
214244(G)	436048 7217951 91035336	35, 36, 152
214365(G)	95 533 625 5415133 5880975	55, 68
214537(G)	5 001 814 5 001 820	95, 96
214636(G)	–	50
214757(G)	5350857 5350875 5351214	257
214809(G)	7576729 5206.59	55, 71, 72, 78, 182, 244
214875(G)	5206.32	178, 179
214880(G)	22 081 313 22 081 314 22 117 661	36, 65, 137, 198, 285
214892(G)	–	19
214921(G)	123456789 91095939 LP694	134, 149
214930(G)	740.154.021.2 251 513 031 D	282
214937(G)	7700 729 342 7700 729 343 7700 788 547	207

SIAAM	OEM	PAGE
214939(G)	251 513 031 251 513 031 B 251 513 031 E	282
214940(G)	96 157 280 5206.60	58, 59, 60, 166, 167, 173, 174, 175
214953(G)	85 GB-18080-BC 85 GB-18080-BE 91 GB-18080-BA	94
214963(G)	7576729 5206.59	55, 72, 79, 182, 245
214994(G)	4843748 4843749 8586273	71, 104
214997(G)	7700734439 7700734445 7700805153	217
215013(G)	8973018424 8973617110 8973685990	102
215015(G)	8973018424 8973686000 8979408454	102
215020(G)	4853109440 4853109460 4853109480	256
215021(G)	UH7428700A	116
215028(G)	4853126390 4853126870 4853126780	254, 255
215031(G)	4853126210 4853126220 4853126230	254
215101(G)	7700 802 611 7700 822 621 7700 824 780	188, 192
215110(G)	–	98
215113(G)	89443-36970 89447-31860 89447-31870	91, 144, 148
215117(G)	7700 709 099 7700 709 100 7700 709 101	220, 221, 222
215124(G)	5206.78	179
215138(G)	AAR 5154 AAR 5155 AAR 5156	64, 98
215145(G)	–	98
215152(G)	AAR6627	64
215160(G)	7678636	17, 69, 70, 74, 79, 108, 109
215161(G)	5206.G3 5206.G4 5206.R0	164
215162(G)	96 130 021 5206.F3 5206.G6	58, 164

SIAAM	OEM	PAGE
215168(G)	48531-26061 48531-26111 48531-80041	254
215172(G)	A 631 320 09 31 A 631 326 03 00 A 661 326 32 00	131
215176(G)	48510-87601 48510-87602 A410923	254
215178(G)	–	245
215188(G)	7700 824 119	199, 200
215194(G)	–	245
215204(G)	MB584272	137
215220(G)	7 355 381 92 VB-18080-GD 95 VX-18080-JA	96
215227(G)	6 958 255 93 BB-18080-AC 93 BB-18080-AD	92
215231(G)	A 850X-18080-CNA A 850X-18080-CRA A 850X-18080-CSA	96
215232(G)	6006001110 6006003822	208
215234(G)	7700 840 636	200
215238(G)	901 320 07 31 2D0 513 029 2D0 513 029 A	131, 276
215243(G)	5206.C3 1347238080 5206.A9	56, 72, 181
215261(G)	55300-43003 56210-J0100 56210-J0125	145
215288(G)	60 25 308 758 60 25 308 760 60 25 308 762	196
215292(G)	5206.H1 5206.H2 5206.N7	51, 182, 183
215296(G)	5206.E3	57, 77, 181
215298(G)	4743 129 4743222AA	49
215318(G)	7619437	74, 79
215321(G)	22 081 313 22 081 314 22 117 661	106, 155, 263
215322(G)	436 085 436 086 97 039 322	103, 157, 263
215352(G)	60 25 308 760 60 25 308 762 60 25 308 763	196
215356(G)	–	260
215375(G)	4743 129 4743222AA	50

SIAAM	OEM	PAGE
215406(G)	46510793 46798864 46415599	74
215430(G)	5621 000 QAK 7700 308 589 7700 312 011	142, 198
215436(G)	7700 413 096 7700 429 977	218, 219
215465(G)	45 00 241 45 00 242 7700 310 740	141, 157, 202, 203
215466(G)	4500243 9160543 4500243	157, 202
215468(G)	5206.N9 5206.R2 9630053087	56, 80, 111, 180
215475(G)	9633627387 5206.R1 5206.N8	57, 77, 181
215484(G)	5206.Q4	167
215485(G)	5206 Q7 5206 R5 5206 V8	167, 168
215486(G)	5206.Q8	167, 168
215487(G)	5202.R5 5206.Q7	
215494(G)	S30A-28-700A S30A28700A S41A28700	117
215527(G)	7700422518 8200033595 8200735212	204
215530(G)	7700437411	219
215537(G)	–	148
215544(G)	5206.S6	59
215561(G)	46827821 46847763 51714758	71
215589(G)	7700312011B	142, 198
215597(G)	8200046851 8200587187	79, 145, 161, 222, 223
215598(G)	46414586 71712474 71712478	108, 109
215601(G)	5206 FF 5206 FS 5206 FT	168, 169, 170
215621(G)	5206.T8 5206.V8 5206.X4	
215623(G)	82 00 038 258 82 00 038 260 82 00 181 921	204, 205, 219
215637(G)	82 00 283 393 82 00 387 240 82 00 387 242	200

SIAAM	OEM	PAGE
215638(G)	82 00 108 182 82 00 108 183 82 00 283 391	200
215639(G)	6013200431 9043200131 2D0513029C	131, 276
215651(G)	56210-35G26 56210-5T025 89412-68400	140, 143
215653(G)	436325 93178640 93182103	152
215678(G)	5206AC 5206AE 1490901080	54, 80, 110, 180
215690(G)	8200041472	198
215714(G)	8200069471 8200122947 8200312454	204
215722(G)	8200256337	197
215724(G)	8200421322	219
215725(G)	5206FF 5206QA 5206QC	
215748(G)	51755255 51755353	71
215761(G)	562100001R 562100007R 562100033R	201
215763(G)	4153260000 562102464R 8200800724	125, 198, 199
215776(G)	5206RK	53
215790(G)	1682554 1690801 1709765	
215797(G)	5206CP 5206EP	179
215803(G)	51810129 51815192 51819223	71, 153
215819(G)	5206VY 5206YX 5206ZZ	55
215824(G)	E6210-JG01A 56210-JG000 56210-JG01A	145
215827(G)	56210JG000 56210JG01A 56210JY01B	149, 199
215831(G)	5206WL	180
215840(G)	5206FW 5206GA 5206TH	57, 77, 181
215844(G)	436607 436615 93168669	156

SIAAM	OEM	PAGE
215851(G)	5206VR 5206VE 5206FX	57, 77, 181
215853(G)	562100028R	219
215856(G)	562100325R 562100664R	197
215860(G)	5206HZ 5206NC 5206PW	53
215871(G)	5206YR 5206RP 5206YQ	51, 54, 183
215872(G)	5206RP 5206RN	51, 183
215880(G)	562102464R 562107865R	61
215885(G)	9802145580	170
215886(G)	9678823080 9678823180	170
215888(G)	562106339R 562101932R	61
215894(G)	A9063200031 A9063200131 A9063200231	131, 268
215895(G)	9063260000 9063260600 9063260800	131, 268
215919(G)	553001M300	100, 101, 106
215937(G)	4853109740 485310K010 485310K050	256
215977(G)	4853142130 4853142140	257
218699(G)	MR992632 MB110517 MB242115	135
231479(G)	GSA200	111, 112
231892(G)	-	112
234603(G)	56210-C6001 56210-C6002 56210-C6025	
235026(G)	4853126550 4853126710 4853180226	254, 255
235029(G)	4853126530 4853126560 4853126700	254
241011(G)	-	152
241344(G)	-	65, 104, 105
241756(G)	-	65, 104, 105
241763(G)	-	252
241782(G)	-	131
244019(G)	-	105, 198, 285
244065(G)	-	36



SIAAM	OEM	PAGE
244088(G)	MB430190 MB430191 MB430195	135, 148, 253, 254
244515(G)	6000056012 6000056757 7701020099	19, 207
244586(G)	48500-0B020 48500-0B030 48500-0B040 4850028060	132, 133, 254, 255
244683(G)	4850029225 4851130090 4851130100	252, 253
244826(G)	291 413 031 291 413 031 A	276
244861(G)	48511 25070 48511 25080 48511 25110	102, 253
244894(G)	–	256
244991(G)	MB349076	137
245010(G)	UH7434700 UH743470X UH7534700A	116
245012(G)	8973722870 8972515562 8973685960	102
245025(G)	48511 26120 48511 26130	254
245027(G)	4851126240 4851126241 4851126280	254, 255
245032(G)	54300-43102 54300-43160 54300-43650	101
245112(G)	56110-0F004 56110-0F056 56110-0F655 561100X000	62, 91, 144, 148, 240
245167(G)	48511-26040 48511-26041 48511-26051	254
245250(G)	56110-R8025 56110-R8026 56110-R8027	145
245513(G)	342006 97179442	155
245536(G)	44002290	148
245581(G)	–	185, 203
245640(G)	E6110-3S525 56110-3S525 56110-3S560	140, 143
245742(G)	56100G4800	148
251075(G)	1 108 041 1 108 672 1 114 383	46
251078(G)	–	102, 103
251596(G)	5205.93	182

SIAAM	OEM	PAGE
251622(G)	A 108 320 01 31 A 108 326 00 00 A 108 326 01 00	223
251626(G)	–	184
251698(G)	108 320 01 31 108 326 00 00 108 326 01 00	118, 119, 120, 121, 122
251710(G)	A 108 320 01 31 A 108 326 00 00 A 108 326 01 00	123
251752(G)	–	99
251974(G)	–	49, 243, 244
254106(G)	911.333.051.00 911.333.051.01 911.333.051.03	184, 185
254113(G)	–	233
254293(G)	7700 531 439 7700 535 291 7700 661 562	207, 211
254328(G)	8 983 064 8 984 433 8 984 446	150, 153, 154, 156, 158, 261
254398(G)	A 123 320 00 31 A 123 320 01 31 A 123 320 03 31	119, 120, 122, 123, 124
254414(G)	436413 436414 90009906	155
254433(G)	5516300350 436437 90023779	251, 252, 253
254484(G)	5205.68 5205.72 5205.85	177, 178, 179, 244
254516(G)	6000056018 6000056758 7701020100	19, 207
254772(G)	431 513 031 431 513 031 A 431 513 031 B	21, 22
254873(G)	7700 690 171 7700 690 172 7700 791 601	221, 222
254962(G)	7700 695 126 7700 700 909 7700 720 277	222
254967(G)	48531-29695 48531-29736 48531-29835	246, 258
254995(G)	90 223 013 90 223 843 90 223 844	153, 154, 159, 262, 263
255203(G)	4853142010 4853142020 4853142030	
255254(G)	1 091 629 33 52 1 091 629	38

SIAAM	OEM	PAGE
255258(G)	33 52 1 090 826 33 52 1 090 830 33 52 1 092 309	38, 39
255273(G)	436 023 90 343 194	153, 261
255316(G)	5206.F0 5206.R8 5206.S1	177
255317(G)	5206H5 5206J3 5206R9	177
255478(G)	5206.F1 5206.J3 5206.J8	177
255500(G)	5206.W3	174, 175
255514(G)	436151 13271702 3451375	155
255554(G)	45301 05203	62, 240
255579(G)	46463861 46466615 46519347	74, 78
255582(G)	–	185, 203
255584(G)	–	
255587(G)	MR418049 MR554291 MR554330	137
255596(G)	5206.V9 5206.W0	53, 174
255603(G)	5208F4 520852 5208Y1	
255613(G)	1K0513029DS 1K0513029EP 1K0513029FA	24, 226, 230, 232, 233, 237, 238, 239, 268, 271, 272, 274, 275, 279, 280, 281
255615(G)	5206W4 5206V0 5206EW	53, 174, 175
255616(G)	1T0 513 029 D 1T0 513 029 E 1T0 513 029 M	282
255657(G)	OK53A28700E OK55F28700A OK55F28700B	106
255659(G)	4530105203	63, 240
255675(G)	562108573R 8022452699 8200382033	194, 205
255734(G)	–	33
255741(G)	1376860 6G91-18080-FAB 6G91-18080-FDC	90, 92, 94
255765(G)	1K0513029FJ 1K0513029FK 1K0513029FL	268
255783(G)	–	28, 30

SIAAM	OEM	PAGE
255788(G)	5206NF 5206NG 5206QE	175
255790(G)	–	80, 90
255793(G)	1K0513029EN 1K0513029EP	239
255818(G)	5206RT 5206ZS	180
255836(G)	7N0513049K 7N0513049B 7N0513049L	281
255839(G)	5206ZJ 5206ZQ 5206ZV	53, 55
255858(G)	5N0513049AA 5N0513049K 5N0513049L	282
255869(G)	22881045	155
255877(G)	562109815R	194
255958(G)	95146942 95146944 95146946	156
255974(G)	562101KA1B 562101KC1B	142
255983(G)	4530105301	63, 240
261168(G)	0854758700 7701204147 7701365944	197
261621(G)	–	197, 223
264243(G)	342 198 9 961 938 91 035 335	35, 36, 152
271345(G)	62197 NFP64054138HADT 276553	65, 104
271675(G)	520523 520526 520531	176, 178
274844(G)	–	224
275757(G)	31316767321 31316767323 31316768211	36, 42
275834(G)	–	38
275835(G)	–	38
311757(G)	801572 NAP64054466CAH NAP64054466CAHW	65, 104, 105
311823(G)	CAC9091 C29444 GSA181	65, 105
314005(G)	6 591 492 6 623 473 6 623 474	84, 85, 93
314045(G)	1 664 103 1 664 107 1 664 108	88

SIAAM	OEM	PAGE
314099(G)	DV90FB18K076AA V90FB18K076AB	88
315187(G)	6 705 925 91 AB-18K076-DE	85, 93
315210(G)	5 030 475 7 135 678 94 FX-18K076-BA	88, 89
315221(G)	94FB18K076BA	88, 89
315266(G)	91AB18K076DE	85
341073(G)	5201.48	182
344093(G)	5201.88	182
344094(G)	7700748643 7700748644	201, 202
344849(G)	7700740299 7701465187	201
345014(G)	8973685950 8972362990 8972449553	102
345276(G)	3B0 413 031 3B0 413 031 A 4B0 412 031 F	26, 27, 28, 29, 31, 277, 278
345372(G)	3B0 413 031 H 8D0 413 031 AE 8D0 413 031 AH	26, 27, 29, 31, 32, 277, 278
345644(G)	8E0 413 031 CT 8E0 413 031 DA	28, 30, 228
345645(G)	8E0 413 031 AM 8E0 413 031 BG 8E0 413 031 CD	28, 30
345646(G)	8E0413031AR 8E0413031AS 8E0413031BJ	28, 30
345667(G)	8D0 413 031 BM	26, 27, 28, 29, 32, 33, 239, 278, 279
345679(G)	5202NZ 5202PA	54, 177, 179
345680(G)	4B0 412 031 BC 4B0 412 031 BD 4B0 412 031 CD	32, 33, 239, 278, 279
345731(G)	4F0413031AA 4F0413031AB 4F0413031AL	33
345732(G)	-	33
345935(G)	4851009G90 4851009G80 4851009K40	
345936(G)	4852009C70 4852009C80 4852009C90	
345981(G)	4431032001 4431032000 4431009003	63, 240
348698(G)	MR992320 MR992321	135

SIAAM	OEM	PAGE
349331(G)	4851009J00 4851009J90 4851009K00	256
351086(G)	11159972 1117042 11177042	46, 47, 48
351717(G)	520562 520563 520564	164, 165, 166, 171, 172
354014(G)	52610-SB2-004 52610-SB2-922 52610-SB3-014	99
354033(G)	21082915004	106, 107
354127(G)	827 513 031 827 513 031 A 827 513 031 B	19
354150(G)	520577 520581 520586	165, 166, 171, 172
354194(G)	520576 520579 520583	162, 163
354374(G)	171 513 031 171 513 033 D 171 513 033 F	269, 281
354448(G)	1 117 992 1 120 125 33 52 1 117 992	42, 43, 46, 47, 48
354469(G)	1 115 997 1 116 231 1 117 463	36, 37
354493(G)	861 513 031 B 861 513 031 C 861 513 031 F	19, 268, 280
354504(G)	-	162
354508(G)	5205.99 5206.01 5206.18	172
354580(G)	5205.98 5206.03 5206.12	49, 58, 163, 164, 244
354619(G)	5205.77 5205.78 5205.81	171, 172
354620(G)	811 513 031 D 811 513 031 E 811 513 031 F	20, 34
354627(G)	5206.08 5206.14 5206.20	58, 162, 163
354681(G)	171 513 033 N 171 513 033 P 175 513 033	269, 273, 275, 281
354711(G)	520598 520603 520612	57
354771(G)	1 118 051 1 118 090 1 118 108	43, 44, 45

SIAAM	OEM	PAGE
354787(G)	4A0 513 031 4A0 513 031 B 4A9 513 031 B	21, 22, 30
354800(G)	893 513 031 AE 893 513 031 AQ 893 513 031 H	20, 34
354806(G)	321 513 031 H 321 513 031 J 321 513 031 K	276, 281
354808(G)	1124982 1124984 1125420	44, 45
354883(G)	–	57
354910(G)	4A0513031C	21, 22, 31
354912(G)	321513031H 321513031J 321513031P	276, 277, 281
354918(G)	5206.30 5206.31	172, 173
354927(G)	–	34
354952(G)	191513033 1H0513031 1L0513033	232, 269, 270, 274, 275, 283, 286
354985(G)	5206.42	173
355108(G)	8A5 513 029 E 8A5 513 029 F 8A9 513 029 D	20
355111(G)	79 47 915 973 94 55 083 780 94 55 341 280	54, 55, 173
355135(G)	357 513 031 J 357 513 031 S 357 513 031 T	277
355180(G)	8200 013 147 8200 103 589 8200 377 364	223
355184(G)	56203-01B25 56203-01B26 56203-01B27	143
355213(G)	1 138 669 33 52 1 138 669	44, 45
355226(G)	1H9 513 031 1H9 513 031 S	274
355230(G)	441 075 803 116 441 075 803 146 441.0.7580-314.6	236
355237(G)	6K0 513 031 D	227, 228, 229
355242(G)	6K0 513 031 M 6K0 513 031 N 6K0 513 031 S	227, 228, 280
355270(G)	436 158 436 159 436 160	160, 263
355277(G)	8D9513031A 8D9513031C 67039	26

SIAAM	OEM	PAGE
355281(G)	436158 72118798 90542737	160, 263, 264
355283(G)	48530-10370 48530-10380 48530-10390	257, 258
355320(G)	V97 FB-18K076-AD V98 FB-18K076-AC 1 057 640	89, 93, 113
355325(G)	1010887 5031027 7385555	86, 87
355326(G)	95 AB-18K076-AC 95 AB-18K076-BC 95 AB-18K076-CC	86
355339(G)	1055066 1055068 1056125	91
355353(G)	4A5 513 031 4A9 513 031 C 443 513 031 P	21, 22, 31
355362(G)	GSA 982815 GSA 982816 RPD 102740	223, 224
355381(G)	562100M500 562100M525 562100M825	138
355470(G)	51601S30004 51605S30A01 95AB18K076CC	86, 87
355479(G)	V98FB18K076BA V98FB18K076CA V98FX18K076BB	89, 113
355481(G)	7385553 95 AB-18K076-DC	86
355499(G)	76103 8D9513031F 8D9513031G	26, 27, 28, 29
355538(G)	6K0513031E 6K0513031M 6K0513031N	227, 229, 280
355545(G)	1075701 1075702 1085444	91
355546(G)	1110571 1230918 1302438	91
355548(G)	–	224
355670(G)	5207AY 5206FG 5206FA 5206EC	54, 177, 179
355733(G)	–	
355966(G)	4853002220 4853002221 4853002240	248, 249, 250

SIAAM	OEM	PAGE
355969(G)	4853002600C 4853002650B 4853012D90	249
355971(G)	4853009870 4853009880	250
364188(G)	7700513675 7700513676 7700520201	61, 210, 211
364399(G)	7700 667 575 7700 676 696 7701 021 933	216, 218
364501(G)	7700 657 017 7700 664 805 7700 672 721	61, 211, 213
364795(G)	7700 681 869 7700 686 594 7700 688 590	197, 212, 213, 214
364814(G)	7700 688 589 7700 695 694 7700 705 058	212, 213
364847(G)	7700 689 536 7700 694 065 7700 700 914	216, 218
364865(G)	7700 667 575 7700 676 696 7701 021 933	216, 218
364920(G)	7700 718 332 7700 722 469 7700 727 233	217
364973(G)	7700 718 332 7700 722 469 7700 727 233	217
365116(G)	6025 006 536 6025 006 537 6025 006 538	195, 196
365154(G)	6025 102 428	196
441009(G)	322960 4851014020 4851014023	246
441704(G)	–	246
441740(G)	–	176
441770(G)	–	81
441772(G)	–	81
441775(G)	–	164, 165, 166, 171
441776(G)	–	184
441784(G)	MB369991 MR103627 MR103628	259, 260
441788(G)	A 70 SX-18124-AA 0 461 007 1 494 800	94
441789(G)	1 451 089 1 463 772 1 463 774	82
441814(G)	–	234

SIAAM	OEM	PAGE
441821(G)	1460150 1460151 1460162	81
441837(G)	–	94
441838(G)	5201.39 5201.40 5201.41	177, 178
441841(G)	1 104 320 1 104 354 1 106 354	46
441848(G)	1 481 050 1 481 051 1 502 437	80
441874(G)	30334910 30534910 30534960	115, 116, 117
441905(G)	–	63
441907(G)	113 412 031 B 113 412 031 C 113 412 031 D	266
441937(G)	911.341.913.03 911.341.913.04	184, 265
441967(G)	–	63, 64
441969(G)	–	63
441971(G)	101983 101984 167571	63, 64, 283
441973(G)	–	49, 243, 244
441977(G)	4207.36 4307.36 5201.34	176
441979(G)	5201.44 5201.47	165, 166, 171, 172
441995(G)	–	265
441998(G)	–	49, 98, 99, 100, 234, 241
444024(G)	520225 520238 520248	178
444028(G)	1273915 1329533 1329534	284
444032(G)	2108-290 5002 2108-290 5003	107
444056(G)	344 170 344 171 344 184	152, 159, 261
444090(G)	48510-12520 48510-12530 48510-12531	248
444126(G)	321 412 503 A 321 412 503 B 321 412 503 C	19, 276
444141(G)	–	141
444164(G)	–	276

SIAAM	OEM	PAGE
444170(G)	82346277 82395525	107, 108, 110
444179(G)	54302-A1128 54302-A1150 54302-A2625	139, 142
444193(G)	5201.46 5201.54 5201.61	57, 162, 163
444197(G)	041500100155 1535292 A740X18K059BFA	80, 83
444206(G)	51601-559-014 51601-654-651 51601-657-671	99
444291(G)	857234960A 5430201S27 5430221025	139, 149
444296(G)	54302-H8529 54303-H1055 54303-H1125	146, 147
444317(G)	48510-12490 48511-12230 48520-12360	64, 246, 247
444338(G)	133 412 031 B 133 412 031 C 133 412 031 G	266
444343(G)	6 059 330 75 AB-3K033-AC 75 AB-3K033-BC	83
444353(G)	-	98, 241, 244
444355(G)	0862-34-900 B 0866-34-700 0866-34-910	113, 114, 115, 117
444361(G)	-	115, 118
444373(G)	171412031 171412031A 171412032	267, 269, 273, 275, 281
444380(G)	-	108
444394(G)	1205810 1221442 1229575	283
444397(G)	75 513 492 75 513 493 75 513 494	211
444404(G)	48510-12490 48511-12230 48520-12360	64, 246, 247, 248
444425(G)	-	265
444428(G)	4851010012 4852010012	257
444444(G)	5202.89 5202.90 5202.97	177, 178, 179, 244
444468(G)	1 111 140 1 116 095 1 118 848	36, 37

SIAAM	OEM	PAGE
444492(G)	861 412 031 B 861 412 031 C 867 413 503	19, 268, 280
444507(G)	3642.61 3642.65 3642.66	171, 172, 173
444529(G)	A150546 MA001671 MB002020	132, 133, 134, 135, 136, 138
444533(G)	MB002060 MB002190 MT002060	135, 136
444588(G)	MB002877 MB111164	250, 251
444606(G)	8171134910 817134910A 817134960	115
444630(G)	54302-W1200 54302-W1225 54302-W1400	140, 141, 142, 145
444638(G)	857234960A 54303K2326 56110U7725	139, 140, 142, 145, 146, 147
444640(G)	22 008 155 22 008 156 22 008 157	35, 62, 63, 153, 155, 156, 260, 261
444641(G)	56110-M3026 56110-M3825 56110-M3826	141
444663(G)	4851010060 4851010070 4851010080	258
444666(G)	344117 90079218 9192289	153, 157, 158, 261, 263, 264
444667(G)	3274776 3296136 3298280	283
444677(G)	CW771JM10E28 TKC1212	260
444685(G)	-	49, 98, 241, 244
444695(G)	-	113, 118
444706(G)	4851012051 4851014012 4852014101	245, 246, 247, 250, 258
444712(G)	54302H8529 54303W5600 56110N8425	146, 147
444730(G)	477 412 031 B 477 412 031 E 477 412 031 F	184, 185
444733(G)	-	108
444740(G)	431421031A 443413031A 4A0413031L	21, 22, 30, 31, 34
444742(G)	7700461057 7700674509 7701461057	211

SIAAM	OEM	PAGE
444749(G)	GSA2019	224
444754(G)	82346272 82395527	145, 147, 148, 149
444758(G)	856223910 887134910	118
444760(G)	1 127 922 1 127 930 1 128 250	42, 43, 44, 45, 46, 47, 48
444796(G)	520164 520173 520176	162, 163
444803(G)	22 008 158 22 008 159 344 125	150, 261, 262
444812(G)	11160952 31321111140 31321123662	37
444817(G)	54302-D0100 54302-D0125 54302-D1110	146
444840(G)	BB62-34-910 BB62-34-910A BB62-34-960	114
444845(G)	48510-12130 48510-12150 48510-12170	64, 247, 248
444863(G)	MB109090 MB109091 MB109101	100, 132, 136, 137
444869(G)	321413503B 811412023B 8G0413503	20, 21, 34, 276, 277
444877(G)	520172 520232 520293	178
444878(G)	MB109850 MB175613 MB175681	133, 134, 138
444882(G)	8171-34-910 A 8171-34-960 A 8171-49-790	115
444896(G)	8545-34-910 A 8545-34-960 A 8595-49-790	116
444924(G)	1 125 474 31 32 1 125 150 31 32 1 125 474	37
444950(G)	344 141 344 142 344 192	150, 261, 262
444951(G)	191 413 031 A 191 413 031 B 191 413 031 C	269, 275
444966(G)	48531-19715 48531-19825 48531-19845	246, 251, 252, 258

SIAAM	OEM	PAGE
444975(G)	48510-16150 48510-16151 48510-16250	258
444996(G)	5202.59 5202.64	178, 179
445100(G)	31 32 1 134 565 31 32 1 134 573 31 32 1 135 675	44
445107(G)	331413503 811412023B 811412024B	20, 34
445109(G)	1 135 416 1 135 674 1 135 858	44
445156(G)	22 081 235 22 081 503 344 205	35, 150, 151, 260
445157(G)	344101 72012304 90511753	151, 260
445159(G)	5202.F3 5202.F4 5202.F6	51, 58, 164
445173(G)	4851012200 4851012330 4851012420	245, 248
445202(G)	4851049015 4851049025 4852049015 4852049025	257
445211(G)	1 091 000 1 092 283 1 138 836	44, 45
445212(G)	1 092 284 1 138 667 1 139 408	44, 45
445228(G)	48510-12550 48510-12560 48510-12720	248
445272(G)	344 100 344 169 344 172	153, 159, 261, 262
445348(G)	893 513 031 AC 893 513 031 AJ 893 513 031 K	
454142(G)	-	141
454181(G)	8124010624 8124010811 82287222	107, 108, 110
454207(G)	52610634675 52610634677 52610664622	99
454391(G)	-	108
454477(G)	82346274 82395817	108
454818(G)	55303-D1125 55303-D1126 55303-D1127	146

SIAAM	OEM	PAGE
455140(G)	853 513 031 853 513 031 B 893 513 031 AK	20, 21, 34
544001(G)	5 024 149 5 024 151 5 024 153	84, 85, 86, 93
544002(G)	5 024 150 5 024 152 5 024 154	84, 85, 86, 93
544008(G)	1 133 914 5 020 532 5 022 276	81, 82, 88
544011(G)	51601-SAO-024 51601-SAO-921 51601-SAO-924	99
544013(G)	51601SB2933 52606SB2935 DBP3958	99
544020(G)	5202.04 5203.18 5203.19	177
544039(G)	7700 789 513 7700 821 211 7700 824 458	215, 216
544040(G)	07 569 730 7569730 5203.13	55, 72, 78, 79, 182, 244, 245
544042(G)	3918879 3918885 3918979	67, 73
544044(G)	1 133 913 5 020 531 5 020 650 5 029 132	88
544048(G)	7700 786 597 7700 807 873	207
544049(G)	SE 021 156 202 B SE 021 156 202 C 3 981 313	228, 231
544053(G)	91 516 880 94 55 304 219	166, 167, 175
544058(G)	71712496 71712505 7601496	69, 79
544061(G)	A 840X-18045-SA A 840X-18045-TA A 840X-18045-UA	94
544091(G)	191413031A	227, 228, 232, 269, 275, 283
544092(G)	1H04130310 535413031B 6K0413031B	227, 228, 229, 232, 269, 270, 274, 275, 283
544097(G)	96 089 254 96 099 827 96 152 056	
544098(G)	96 152 057 96 152 064	

SIAAM	OEM	PAGE
544451(G)	5 002 793 5 002 794 5 005 855	87
544659(G)	3911899 3918886 3918980	35, 107
544810(G)	3919791 4323772 4349546	67, 225
544811(G)	151605SA0721 51601SA07330 51601SA20440	67, 225, 226
544819(G)	75 528 490 75 531 487 79 40 010 134 520165	49, 54, 57, 58, 163, 164, 244
544821(G)	4434935 4415467 4423095	67, 225
544825(G)	3918879 3918885 39189793	66, 67, 73, 184, 225
544828(G)	3929374 3930380 4400897	76, 231, 286
544860(G)	5 006 153 5 006 155 5 006 331	83
544881(G)	–	87
544884(G)	7700 698 566 7700 700 913 7700 717 994	62, 209, 210
544890(G)	83 BB-18045-AA 83 BB-18045-BA 83 BB-18045-CA	94
544906(G)	3945597 3950130	228, 231
544907(G)	A 830X-18045-KA A 830X-18045-LA A 830X-18045-SA	84, 93
544909(G)	51601SA5013 51601SA5952 51606SA5033	99
544911(G)	520204 520205 520240	173
544913(G)	1613623 4428843	286
544915(G)	4434849 4434905 4434906	74, 231, 232
544932(G)	A 124 320 23 30 A 124 320 24 30 A 124 320 31 30	118
544936(G)	6001008923	207
544941(G)	5203.14 5203.15 5206.57	54, 58, 166, 167



SIAAM	OEM	PAGE
544943(G)	5947920 71712495 71736468	74
544944(G)	84 AB-18045-BD 84 AB-18045-FC 84 AB-18045-FD	83, 84, 92
544945(G)	7700732743 7700732744 7700807874	207, 208
544947(G)	A830X18045DSA	87, 88
544948(G)	5202.46	58, 166, 175
544949(G)	5202.47	58, 166, 175
544954(G)	5938080 5951867 7592912	80
544958(G)	4 401 503 9 109 503	220, 221, 222
544959(G)	4 401 502 9 109 502	220, 221, 222
544960(G)	4434813 4439223	55, 71, 72, 182, 244
544961(G)	–	55, 72, 78, 182, 245
544964(G)	5963821 5963822 5963943	76, 77
544974(G)	–	207
544976(G)	1243200730 1243202130 1243203830	118, 119, 120, 121, 122, 123, 124, 125, 126, 127, 128, 129
544977(G)	A830X18045ECA EAN309	87
544981(G)	7700 734 438 7700 736 784 7700 802 342	216, 217
544982(G)	7700 734 436 7700 734 441 7700 736 765	217
544983(G)	7700 734 437 7700 734 442 7700 736 766	217
544989(G)	1141583 5018710 87VX18045CA	96
545011(G)	546600X100 546600X200	101
545102(G)	GB-18045-BD 85 GB-18045-BE 85 GB-18045-DC	94
545122(G)	5202.A7 5202.C2 5202.C4	179
545123(G)	22693-00QAA 1920 6C 77 01 055 723	179

SIAAM	OEM	PAGE
545133(G)	SE 021 156 202 D SE 021 156 202 E	228, 231
545134(G)	357 413 031 B 357 413 031 C 357 413 031 E	277
545141(G)	82423132 82423135 82435708	70, 110
545155(G)	5202.66 94550680 94554204	54, 55
545163(G)	5202P91 5202P93 5202AW	59, 60, 174
545164(G)	5202Q31 5202Q32 5202ES	59, 60, 174
545165(G)	5202.G3 5202.S4 5202.T2	
545166(G)	5202.G4 5202.S8 5202.T3	
545169(G)	V90FB18045AA V90FX18045AA	88
545174(G)	96113426	59
545175(G)	96113427	59
545179(G)	22 051 307 22 051 308 22 054 850	153, 154, 159, 262, 263
545183(G)	54302-04B11 54302-04B16 54302-04B25	143
545189(G)	7700 421 668 7700 821 058 7700 838 055	223
545190(G)	7700 830 490	199, 200
545193(G)	7752624 7778834	75
545195(G)	7700 823 130 7700 828 680 7700 838 084	185, 186, 187, 188, 189, 190
545196(G)	7700 828 682 7700 838 083 7700 838 086	186, 187, 188, 189, 190, 191, 192
545197(G)	7700 803 442 7700 828 684 7700 838 085	188, 192
545199(G)	7700 830 491 7700 830 492	199, 200
545201(G)	7700 830 491 7700 830 492	227, 228, 229, 232, 267, 270, 274, 276, 280, 283
545206(G)	41601A60A00 4160256B00 4160156B00	242

SIAAM	OEM	PAGE
545214(G)	5203.18 5203.19 5203.27	177
545215(G)	71713673 7685654	70, 78
545216(G)	7638139 7642277 7648479	74, 79, 108, 109
545217(G)	5 030 064 5 030 065 94 FB-18045-CA	88, 89
545219(G)	5029133 5029137 5030062	82, 88, 89
545223(G)	D93 BB-18045-BG 1 020 660 5 027 606	91, 92
545229(G)	92 VB 18045 AA 92 VB 18045 AB 92 VX 18045 AA	96
545233(G)	7700 428 728 7700 815 917 7700 815 919	218
545239(G)	AT 51971 S 115 495 000 115 495 001	236
545240(G)	1 090 207 31 31 1 090 205 31 31 1 090 207	38
545246(G)	1 140 231 31 31 1 090 203 31 31 1 140 231	38
545247(G)	1 140 232 31 31 1 090 204 31 31 1 140 232	38
545248(G)	1 091 773 31 31 1 090 711 31 31 1 090 713	38, 39
545249(G)	1 091 774 31 31 1 090 712 31 31 1 090 714	38, 39
545251(G)	1 090 208 31 31 1 090 206 31 31 1 090 208	38
545252(G)	1 091 091 31 31 1 090 455 31 31 1 090 457	38, 39
545253(G)	1 091 092 31 31 1 090 456 31 31 1 090 458	38, 39
545255(G)	357 413 031 Q 357 413 031 R	277
545260(G)	7700 789 515	215, 216
545263(G)	1307633080 1312312080 1317926080	56, 72, 181

SIAAM	OEM	PAGE
545265(G)	91 AB-18045-GE 91 AX-18045-FE 91 AX-18045-GE	85
545274(G)	1J0 413 031 AB 1J0 413 031 AC 1J0 413 031 AE	23, 229, 232, 237, 266, 267, 270, 274
545278(G)	344 002 344 004 344 297	160, 263
545279(G)	344 005 344 294 344 306	160, 263
545280(G)	5202.EP 5202.ER 5202.P9	51, 58, 59, 173, 174, 182, 183
545282(G)	3410215 3436688 3436689	283
545284(G)	1477511080 5202.H4	56, 79, 80, 111, 180
545285(G)	46408237	110
545287(G)	60 25 303 083 60 25 303 084 60 25 303 085	196
545289(G)	5202.K8 1478098080 5202.K7 5202N8	57, 77, 181
545291(G)	5202T4 5202AV 5202F7	51, 58, 59, 173, 174, 182, 183
545293(G)	5202AW 5202G0 5202P4	51, 59, 60, 173, 174, 183
545294(G)	5202EV 5202Q5 5202R9	51, 59, 60, 173, 174, 183
545295(G)	543021082R 7700412915 8200059876	203, 204, 218, 219
545297(G)	4322728 4449074 4449075	49
545299(G)	7700 310 097	208
545311(G)	46407181	69, 70
545312(G)	71716547 71716574 7752624	75
545314(G)	5202L0 5202Q7 5202Z5	177
545315(G)	5202L1 5202Q8 5202Z4	177
545323(G)	1010258 7379682 95AX18045HD	86, 87

SIAAM	OEM	PAGE
545324(G)	1015791 7399377 95AX18045EE	86, 87
545328(G)	96FB18045AN 96FX18045EM 1E0334910	82, 89, 93, 113
545329(G)	1088074	82, 89, 113
545331(G)	7700840265	203, 204
545335(G)	97BG 18045 AB	92
545336(G)	1007499 7M0 413 031 G 7M0 413 031 D	90, 226, 281
545338(G)	XS 51-18045-CB 1037187 3S 51-18045-DB	91
545340(G)	5202.J8 5202.K0	179
545349(G)	5202.J7 5202.J9	179
545350(G)	54302-4F125 54302-4F126	143
545351(G)	443 621 251 010	236
545357(G)	513030N525 543020N326 543030N500	138, 139
545358(G)	543020N300 543020N526 543030N326	138, 139
545359(G)	54303-4F125 54303-4F126	143
545365(G)	7700 423 729	187, 188, 192
545366(G)	7700 434 923 7700 839 378 8200 193 013	193
545367(G)	7700 428 438 7700 428 602 7700 839 379	193
545376(G)	46407183 7777585	69, 70
545377(G)	46463129 46463132	73, 74
545400(G)	1073878 1073884 1073885	90
545401(G)	1094561 31311094561 6750785	39, 40, 41, 42
545402(G)	1094567 31306757363 6750787	39, 40, 41, 42
545403(G)	1094568 31306757364 6750791	39, 40, 41, 42
545405(G)	46798863	74

SIAAM	OEM	PAGE
545407(G)	46749446 46749452 46749454	76
545409(G)	1074106 1074111 1074112	90
545435(G)	7700 844 056	218
545438(G)	7700311596 7700311597 7700314021	142, 198
545454(G)	48520-10300 48520-19205 48520-19206	258
545455(G)	48510-19545 48510-46011 48510-49095	258
545460(G)	5202.LY 5202.W6 5202.W9	167, 168
545469(G)	5202.LX 5202.W5 5202.W8	167, 168
545471(G)	4 401 502 9 109 502 7700 690 167	221, 222
545472(G)	4 401 503 9 109 503 7700 690 168	221, 222
545473(G)	SE 028 156 220 A	231
545482(G)	5202.EY 5202.NF 5202.Y8	167, 168
545483(G)	5202.EZ 5202.NG 5202.Y9	167, 168
545490(G)	1 094 561 1 096 849 31 31 1 094 561	39, 40, 41, 42
545497(G)	46749450 50701477 50701550	75
545501(G)	5Z0 413 031 D 5Z0 413 031 IB 5Z0 413 031 N	23, 235, 236, 280
545505(G)	5202.J5 1334894080 5202.J2	56, 72, 181
545506(G)	5202AZ 5202CA 5202CF	59
545507(G)	5202CG 5202GQ 5202JR	59
545508(G)	5202.CY 5202.EA	53, 174, 175
545509(G)	5202.CZ 5202.EC	53, 174, 175
545517(G)	-	81

SIAAM	OEM	PAGE
545519(G)	A 638 320 03 13 A 638 320 06 13 A 638 320 07 13	129, 132
545520(G)	93 170 491 93 170 514 93 170 563	151, 152
545521(G)	48510-52030 48510-52031 48510-52032	259
545522(G)	48510-52660 48510-59205 48510-59206	259
545528(G)	46749446 50701479 50701558	76
545531(G)	344 054 344 058 344 062	151, 152
545532(G)	93 170 514 93 170 563 93 175 473	151, 152
545533(G)	72 119 106 72 119 131 93 170 465	151, 152
545540(G)	A 904 320 07 30 A 904 320 08 30 A 904 320 13 30	131, 276
545541(G)	46519345 46519346 46519349	74, 78
545542(G)	5202.Z6	59
545543(G)	5202.Z7	59
545547(G)	RPD 102740 RPD101700 RPD101710	224
545549(G)	A 168 320 12 30 A 168 320 17 30 A 168 320 31 30	124
545550(G)	46791279 46812368 51748514	71
545551(G)	8200013146 8200041570 8200041572	223
545552(G)	344 000 344 041 72 119 079	161
545553(G)	344 001 344 042 72 119 0803	161
545558(G)	VP2S7W-18K045-BA VP2S7W-18K045-BB VP2S7W-18045-BC	92
545562(G)	7700437273	219
545563(G)	8Z0413031AB 6O0413031AH 8Z0413031S	23, 235, 236

SIAAM	OEM	PAGE
545566(G)	6Q0413031BM 5Z0413031C 6Q0413031CD	228, 229, 239, 269, 280
545568(G)	72119123 72119115 93177879	153, 154, 156, 159
545569(G)	72 119 124 72 119 129 93 183 570	153, 154
545578(G)	8200 117 296 8200 117 297 8200 117 298	200
545580(G)	5202.GW 5202.GY	52, 180
545588(G)	–	142, 198
545591(G)	5202.GX 5202.GZ	52, 180
545593(G)	4408049 7701066474	145, 161, 222, 223
545594(G)	5202.CY 5202.EA	53, 174
545595(G)	5202.CZ 5202.EC	53, 174
545599(G)	50703687 50703688 50705410	73, 110, 111
545600(G)	–	70, 159, 160, 161
545604(G)	5208T5 5208T6 5208Y2	57, 73, 76, 180
545607(G)	5202WE 5202WG 520829	168, 169, 170
545608(G)	5202WF 5202WH 520830	168, 169, 170
545609(G)	51757121 51782168 51804881	70, 159, 160, 161
545610(G)	A 904 320 07 30 A 904 320 08 30 A 904 320 13 30	131, 276
545611(G)	1K0413031AH 1K0413031AS 1K0413031BS	24, 226, 230, 232, 237, 239, 267, 268, 271, 272, 274, 275
545612(G)	1T0413031CP 1T0413031DA 1T0413031DB	24, 226, 230, 233, 237, 238, 239, 267, 268, 271, 272, 274, 275, 279, 280, 281
545614(G)	1T0 413 031 AS 1T0 413 031 AT 1T0 413 031 BA	282
545617(G)	1541948 2T1418045AJ 2T1418B038AA	95, 97

SIAAM	OEM	PAGE
545622(G)	2200222457 8200122218 8200222460	204, 205
545624(G)	50700691 50702878 50705405	70, 78, 109
545626(G)	46463077 46519345 46519350	74, 78
545628(G)	1094565 31311094565 31311095911	39, 40, 41, 42
545629(G)	31306757043 31306757044 5206V8	39, 40, 41, 42
545634(G)	E43A3-BC60A E4303-BC40C E4303-BC60B	143
545635(G)	54302AX626 E43A2BC60A	143
545641(G)	1206036 1216074 1227712	89, 90, 113
545642(G)	1206034 1216073 1227710	89, 90, 113
545650(G)	2N11-18145-AA 2N11-18145-AB 2N11-18145-AC	90
545654(G)	4852049016 4852049026	257
545655(G)	4851049016 4851049026	257
545661(G)	1207445 1215298 1215299	90
545668(G)	543020103R 543022344R 6001550701	61, 62, 107
545671(G)	1365714 1366820 4M5118045AAA	80, 90
545672(G)	1348850 1366825 4M5118045PBC	80, 90, 125
545674(G)	543020808R 543022134R 543026122R	194, 205
545676(G)	5202 FY 5202 FW 1400033180	54, 80, 110, 180
545677(G)	5202 FZ 5202 FX 1400033280	54, 80, 110, 180
545681(G)	B32T34900C B32T34900D B32T34900E	113

SIAAM	OEM	PAGE
545682(G)	B32T34700C B32T34700D B32T34700E	113
545688(G)	4852042060 4852042070 4852049305 4852049315	257
545689(G)	4851042060 4851042070 4851049195 4851049205	257
545691(G)	50703297 50703298 50703308	75
545692(G)	50703297 50703298 50703308	75
545696(G)	5202 RX 5202 RZ 5202 SC	51, 164, 245
545697(G)	5202 RW 5202 RY 48520-0H010	51, 164, 245
545699(G)	8200311206 8200472411 8200106122	219
545701(G)	A 169 320 01 30 A 169 320 08 30 169 320 01 30	125
545703(G)	5208G0 5208H1	53, 55
545704(G)	5208G1 5208H2	53, 55
545705(G)	1521761 1535747 1547172	89
545706(G)	1514406 1535749 1547174	89
545708(G)	VYC15-18045-AE 2C11-18045-AA 2C1618045BA	96
545710(G)	5202HF 5202KA 5202KG	52
545711(G)	8200367895 8200367898 8200625500	223
545716(G)	93195740 93179692 344666	152, 161
545717(G)	93195747 93179693 344667	152, 161
545719(G)	5202SL 5202JZ	52

SIAAM	OEM	PAGE
545720(G)	41601-70C21 41601-51KA1 ,41601-51KD1	150, 242
545726(G)	543039U000	143
545727(G)	543029U000	143
545729(G)	41602-70C10 41602-70C21 41602-51KA1	150, 242
545730(G)	–	159, 160, 161
545735(G)	344659 51783654 51796541	154
545736(G)	344660 51783653 51796448	154
545737(G)	1376814 1376829 1376842	90, 92, 94
545738(G)	1376814 1376829 1376842	90, 92, 94
545739(G)	–	159, 160, 161
545744(G)	51860012 51860149 51862433	68, 91
545745(G)	51860011 51860148 51864795	68, 91
545747(G)	–	223
545750(G)	–	201
545751(G)	6R0413031C 6R0413031Q	22, 23, 229, 233, 236, 239, 281
545753(G)	1303843 1303812 3S5118K001EA	91
545754(G)	3S5118045EA 3S51 18K001 CE 3S5118045BE	91
545755(G)	31316768915 31316771178 31316771553	36, 42
545756(G)	31316768916 31316771178 31316771554	36, 42
545759(G)	9063200433 9063200733 9063200833	131, 268
545762(G)	8200868516	198, 199
545766(G)	485100D170 485200D150 485200D210	259
545767(G)	485100D420 485100D460 485100D400	259
545771(G)	5202VF 5202VH 520857	168, 169, 170

SIAAM	OEM	PAGE
545772(G)	5202VJ 5202VL 520858	168, 169, 170
545774(G)	5208C7 5208C4	53
545775(G)	5208C5 5208C6	53
545780(G)	50508919 50516722 50510010	18
545782(G)	–	28, 30
545784(G)	5202VN 5202VC 5202YN	53, 55
545785(G)	5202VE 5202VP 5202YP	53, 55
545786(G)	520803 520813 520809	175
545787(G)	520804 520814 520899	175
545789(G)	50508644	18
545795(G)	5202AN 5202RJ 5202AE	179
545796(G)	5202AL 5202RK 5202AF	179
545801(G)	51810400	71, 153
545802(G)	51810401	71, 153
545804(G)	1400567680	57, 77, 181
545805(G)	1400567380	57, 77, 181
545806(G)	50513930	18
545807(G)	50513936	18
545810(G)	520881 520873 9684108380	51, 53, 54, 183
545813(G)	8200813791	61
545816(G)	5208G2 5208E8 5208E6	180
545817(G)	5208G3 5208E9 5208E7	180
545820(G)	5208K5 5208K7 5208K9	180
545821(G)	520882 520874 9684108480	51, 53, 54, 183
545822(G)	54303JD00A 54303JD01A 54303JD70A	145

SIAAM	OEM	PAGE
545823(G)	54302JD00A 54302JD01A 54302JD70A	145
545825(G)	E4303-JG71A E4303-3UB0A 54303-JG000	149, 199
545826(G)	E4302-JG71A E4302-3UB0A 54302-JG000	149, 199
545828(G)	5208L2 5208L3 5208L6	56, 57, 72, 181
545829(G)	5208K4 5208K6 5208K8	180
545830(G)	5202 ZK 5208 L4 50706280	57, 72, 181
545832(G)	–	38
545833(G)	–	38
545837(G)	5208T7 5208V5 5208K6	53, 55
545838(G)	5208V8 5208X8 5208W8	53, 55
545841(G)	543020008R	205
545842(G)	344576 93168544 344606	156
545843(G)	344577 93168545 93168996	156
545846(G)	8200591289	125, 198, 199
545847(G)	96410165 96410167 96586885	48, 62
545848(G)	96410166 96410168 96586886	48, 62
545852(G)	543020017R 543022646R 543025246R	219
545855(G)	543020032R 543023532R 5430223826R	197
545857(G)	5N0413031AA 5N0413031K 5N0413031L	282
545864(G)	13324868 13333973 13333979	48, 152
545865(G)	13324867 13333974 13333978	48, 152
545867(G)	–	155
545868(G)	–	155

SIAAM	OEM	PAGE
545870(G)	1682454 1682645 1682821	80, 90
545873(G)	543029731R 543021807R	62
545876(G)	543020808R 543022134R 543026122R	194
545879(G)	1682455 1682818 1686683	80, 90
545881(G)	9801729280 9802144580 9801729080	170
545882(G)	9801729380 9802144680 9801729180	170
545883(G)	9801729580	170
545884(G)	9803520480 9801729680	170
545887(G)	543023390R	61
545889(G)	543020964R	61
545891(G)	543024260R 543023022R 543020322R	61, 62, 194, 220
545892(G)	543020322R 543022905R 543024260R	61, 62, 194, 220
545896(G)	4705728 4160254C50 4160278F00	150, 243
545897(G)	4700330 4160154C50 4160178F00	150, 243
545898(G)	54650-1E000 54650-1E200 54650-1E300	100, 101, 106
545899(G)	54660-1E000 54660-1E200 54660-1E300	100, 101, 106
545900(G)	546500X100 546500X200	101
545902(G)	485100D0571	
545906(G)	543020103R	62
545912(G)	9678117580	55, 170
545913(G)	9678117480	55, 170
545914(G)	5465007100	106
545915(G)	5466007100 5466007200	106
545917(G)	54651-1M000	106
545918(G)	54661-1M000	106
545922(G)	1611448780	175
545926(G)	546501Y100	106
545927(G)	546601Y100	106

SIAAM	OEM	PAGE
545938(G)	546501R300 546501R301 546501R401	100, 101, 106
545939(G)	546501E200 546501E000 546601G100	100, 101, 106
545940(G)	–	180
545941(G)	54650-1J051	101
545942(G)	54603-1J001	101
545943 (G)	543020044R 543029774R 8200688797	144, 157, 203
545948(G)	9676635880 9676636080	180
545949(G)	9676635980 9676636180	180
545951(G)	–	180
545953(G)	–	53
545954(G)	–	53
545956(G)	–	156
545957(G)	–	156
545959(G)	–	223
545961(G)	–	149
545962(G)	–	149
545964(G)	4851002190 4851002200 4851002210	248, 249
545965(G)	1852013070 4851002110 4851002190	248, 249
545967(G)	4852012C20 4852012C30 4852080141	249
545968(G)	4851012D20 4851012D30 4851002650	249
545972(G)	54303BA61A 54303BA62A	142
545973(G)	54302BA61A 54302BA62A	142
545975(G)	4852080071 4852080072 4852080074	257
545976(G)	4851080284 4851080285 4851080287	257
545978(G)	543031HJ0A 543031HJ1A E43031HJ0A	143
545979(G)	543021HJ0A 543021HJ1A E43021HJ0A	143
545990(G)	546512S000 546512Y010 546513U000	101, 106

SIAAM	OEM	PAGE
545991(G)	546513X050 546513X051 546513X151	100
545992(G)	546613X050 546613X051 546613X151	100
545993(G)	54651-A7100 54651-A7400	106
545994(G)	54661-A7100 54661-A7400	106
545996(G)	54650B4100	100
545997(G)	54660B4100	100
545999(G)	546612S000 546612Y010 546613U000	101, 106
548222(G)	4434952 4458676 4459676	71
548443(G)	50013572	73, 80
548515(G)	96409541	
548516(G)	96409542	
554012(G)	52611-693-014 52612-SAO-004 52612-SAO-034	99
554043(G)	4467262 4494966 4459572	73
554452(G)	A 760X-18080-AA A 760X-18080-BA A 760X-18080-CA	87, 88
554769(G)	SE 021 157 200 A SE 021 157 200 B SE 022 157 200 A	76, 77, 228, 231
554851(G)	4435011 4466088 4466089	35, 66, 67, 73, 107, 184, 225, 226
554852(G)	4434923 LF 160 101 04 46621499	67, 184, 225, 286
554871(G)	A 800X-18K076-BA A 800X-18K076-CA A 800X-18K076-EA	83, 84, 92, 93
554900(G)	52610SA3621 52611SA5671 52611SB0013	99
554923(G)	7700 589 341 7700 636 367 7700 692 398	216, 218
554931(G)	77 00 718 471 77 00 729 915 77 00 793 838	217
555018(G)	96394591L 7441140	49, 63
555019(G)	96394592	49, 63
555142(G)	5984022 82434794 82407540	70, 110



SIAAM	OEM	PAGE
555225(G)	5 027 610 5 027 612 93 BB-18K076-HB	91, 92
555235(G)	7700 426 727 7700 816 047 7700 819 547	218
555518(G)	–	81
555559(G)	1S71 18A076 AC 1S71- 18A076- BC 1S71- 18K076- DA	92
555815(G)	8200811407 562103964R	61
558444(G)	50013573	73, 80
558517(G)	96394591	
613214(G)	7700 738 864 7700 790 248 7700 796 512	217
613216(G)	1133935 92FB18K076AA 92FB18K076AF	82
701059(G)	–	219, 220
704442(G)	GSA196	111, 112
714004(G)	4853169385 4853169386 6Q0513025S	256
714018(G)	52088202 52088202AC	105, 198
714022(G)	6113200031 6113200131 6113200231	130
714063(G)	5621001J00 5621001J25	144
714067(G)	48531-36200 48531-60340 48531-69136	256
714077(G)	–	253
714744(G)	–	219
714833(G)	48531-60200 48531-69066 48531-69125	19
714968(G)	5206AF	55, 72, 78, 182, 245
714988(G)	A 850X-18080-CJA A 850X-18080-CKA A 850X-18080-CLA	96
715034(G)	UA3J28700A UA3J34700A UP2128700C	116
715121(G)	–	98
715244(G)	5206.C6 1303816080 5206.C2	56, 72, 181
715477(G)	HR212800	100
715489(G)	MB111214 MR151235	134

SIAAM	OEM	PAGE
715496(G)	8-97304-753-0 97 120 038 4 36 262	155, 263
715573(G)	56210-VB010 56210-VB025 56210-VB026	144
715666(G)	MR210742 MR374117 MR448499	137
715794(G)	56110-EB30-A 56110-EB32-B 56110-EB71-A	144
715862(G)	5206JN 5206JL 1356967080	72, 181
715863(G)	5206KH 5206KG 1355828080	72, 181
724068(G)	48511-60220 48511-60230 48511-69285	
724866(G)	460 323 04 00 004 323 09 00 721.154.022.0	129, 182
725333(G)	A 005 323 31 00 A 005 323 72 00 A 005 323 73 00	129
734069(G)	48531-69336 48531-69355 48531-69356	256
735459(G)	701 513 031 F 701 513 031 G 701 513 031 M	282
744003(G)	4851160120 4851160170 4851169356	256
744017(G)	52003288AD 52087900 52087900AD	105, 198
744066(G)	48511-69265	256
744073(G)	4851035010 4851035040 4851039015	255, 256, 281
744075(G)	48511-35130 48511-35280 48511-35290	253, 255, 256, 282
744081(G)	MB176291 4850028060 4850029385	134
744832(G)	AT103297M	19
744938(G)	5 018 050/EAB 1291/ VM 251 413 031 251 413 031 B	282
744987(G)	A 850X-18045-BBA A 850X-18045-BCA 5 014 339	96
745033(G)	UA3J3470X	116

SIAAM	OEM	PAGE
745268(G)	MB633900 MB633915 MR448498	137
745310(G)	22118267 344245 72118267	155, 157, 263
745319(G)	22081311 22118267 72081311	103, 155, 157, 263
745458(G)	7D0 413 031 C 701 413 031 701 413 031 A	282
745476(G)	HB217100A MB109661A	100
745488(G)	MR151227	134
745658(G)	8-94226-944-0 9-51630-128-0 9-51630-659-0	63, 240
745663(G)	54310H1150	101
751879(G)	–	219
754078(G)	–	253
754867(G)	A 003 326 03 00 A 003 326 10 00 A 003 326 12 00	129, 182
755269(G)	MB663364 MB663365	137
755334(G)	A 003 326 13 00 A 004 326 04 00 003 326 13 00	129
755574(G)	48531-69495 48531-69496 48531-69505	256
755664(G)	55300H1150 55300H1160 55310H1150	101
755808(G)	50519035 50520184 50520186	18
755960(G)	4853009R00 4853009R20 4853009T50	245, 249
761878(G)	–	219
764060(G)	48511-60391 48511-60480 48511-69185	256
764062(G)	56110G9800	144
764836(G)	56110-C6001 56110-C6025 56110-C6026	144
765572(G)	56110-VB026 56110-VB700 56110-VB725	144
771659(G)	–	219
774231(G)	–	220
814441(G)	9516306610 242998 243000	111, 112

SIAAM	OEM	PAGE
825480(G)	–	112
830121(G)	GSA393	111, 112
834047(G)	STC291 GDA1007 NRC8454	111, 112
834443(G)	276937 90508043 168724	112
835491(G)	–	112
841899(G)	–	218
854071(G)	48531-69235 48531-69236 48531-69245	256
860110(G)	242997 503228 91264601	111, 112
871718(G)	–	65, 95
871890(G)	–	218
155890R(G)	553101G110 553101G210 553101E200	100, 101, 106
545702(G)	A 169 320 04 30 A 169 320 10 30 A 169 320 11 30	125
715861(G)	1355825080 1355831080 1357470080	56, 57, 72, 181



---

**LISTE NUMÉRIQUE**  
**NUMERICAL LISTING**

---

[www.sia-am.com](http://www.sia-am.com)

SIAAM	Type de fixation / Mounting Type	Position	Modèle / Model
101125(G)	SC	AV	RENAULT FREGATE
101130(G)	SC	AV	PANHARD DYNA / 24
101151(G)	SC	AR	FORD EUROPE TANUS HILLMAN MINX PEUGEOT403 SIMCA FRANCE ARONDE SINGER GAZELLE / VOGUE SUNBEAM RAPIER
101151(G)	SC	AV	CITROEN TRACTION
101153(G)	SC	AV	CITROEN TRACTION
101162(G)	SC	AR	VAUXHALL VIVA WILLYS JEEP
101333(G)	SC	AV	VOLKSWAGEN 1200
101334(G)	SC	AR	VOLKSWAGEN 1200-1300-1500 / TRANSPORTER
101404(G)	SC	AV	VOLKSWAGEN 1500 / 1600
101468(G)	SC	AV	VOLVO PV
101475(G)	SC	AV	SAAB 93 / 95 / 96 / 97
101495(G)	SC	AV	AUSTIN MINI INNOCENTI 90 - 120 / MINI MORRIS MINI WOLSELEY HORNET
101507(G)	SC	AV	WILLYS JEEP
101508(G)	SC	AV	COURNIL
101508(G)	SC	AR	COURNIL
101511(G)	SC	AV	CITROEN H
101512(G)	SC	AV	CITROËN H
101623(G)	SC	AV	ROVER 2000>3500
101641(G)	SC	AV	WARTBURG
101748(G)	SC	AV	VAUXHALL VIVA
101766(G)	SC	AV	MATRA 530
101803(G)	SC	AV	VAUXHALL VIVA
101808(G)	SC	AV	VOLKSWAGEN TRANSPORTER
101828(G)	SC	AV	SAAB 99
101861(G)	SC	AV	FORD TRANSIT 1
101871(G)	GC	AR	PEUGEOT403 / 404 / 504
101871(G)	SC	AV	JENSEN VAUXHALL FIRENZA / MAGNUM / FD / VIVA
101887(G)	SC	AV	LANCIA FLAVIA
101922(G)	SC	AV	STEYR PUCH
101922(G)	SC	AR	STEYR PUCH
101993(G)	SC	AV	FORD CORTINA / TAUNUS
104158(G)	SC	AV	VOLKSWAGEN TRANSPORTER
104534(G)	SC	AV	DAIHATSU FOURTRACK & ROCKY & TAFT & WILDACT EBRO JEEP
104534(G)	SC	AR	DAIHATSU WIDE CAB HONDA CIVIC
104689(G)	SC	AV	VAUXHALL FE
104770(G)	SC	AV	JEEP CHEROKEE RENAULT JEEP WILLYS CHEROKEE & WAGONEER
104789(G)	SC	AV	MERCEDES L-SERIES
104992(G)	SC	AV	NISSAN VANETTE

SIAAM	Type de fixation / Mounting Type	Position	Modèle / Model
105128(G)	SC	AR	EBRO JEEP BRAVO MITSUBISHI FORTE NISSAN SUNNY - SENTRA POLONEZ PICK UP & TRUCK
105137(G)	SC	AV	DAF 200 FREIGHT ROVER SHERQA
105139(G)	SC	AV	NISSAN VANETTE
105147(G)	SC	AV	MORRIS MARINA
111152(G)	SC	AR	CITROEN TRACTION
111163(G)	SC	AR	WILLYS JEEP
111342(G)	SC	AR	TRIUMPH GT6/HERALD/SPITFIRE
111366(G)	SC	AR	FIAT 1100, 1200, 1500 HILLMAN HUNTER / MINX HUMBER SCEPTRE SINGER VOGUE
111426(G)	SC	AR	CHRYSLER ESP
111496(G)	SC	AR	FIAT 1300, 1500 POLSKI
111528(G)	SC	AR	MOSKVITCH
111553(G)	SC	AR	LANCIA FLAVIA / FULVIA
111700(G)	SC	AR	VOLKSWAGEN TRANSPORTER
111767(G)	SC	AR	MATRA 530
111780(G)	SC	AR	FORD ESCORT 1 & 2
111807(G)	SC	AR	AUTOBIANCHI
111867(G)	SC	AR	FIAT 124 LADA KALINKA / VAZ SEAT 124
111868(G)	SC	AR	TRIUMPH GT6
111908(G)	SC	AR	VOLKSWAGEN 1300>1600
111919(G)	PL	AV	RENAULT SG SERIES
111919(G)	SC	AR	FORD ESCORT
111955(G)	SC	AR	NISSAN TOYOTA CROWN
111994(G)	SC	AR	FORD CORTINA / TAUNUS HYUNDAI STELLAR
114000(G)	SC	AR	AUSTIN MAESTRO VAN
114007(G)	SC	AR	FORD ESCORT5&6
114029(G)	SC	AR	VOLVO 740 / 760 / 780 / 940 / 960
114036(G)	SC	AR	ISUZU FASTER & RODEO
114038(G)	SC	AR	RENAULT ESPACE1&2
114050(G)	SC	AR	BEDFORD ASTRA OPEL COMBO A & B / CORSA B / KADETT E
114054(G)	SC	AR	RENAULT CLIO1
114059(G)	SC	AR	ALFAROMEO 155 FIAT BRAVA / BRAVO1 / TEMPRA / TIPO LANCIA DELTA
114104(G)	SC	AR	VOLVO P
114122(G)	SC	AR	LANCIA FULVIA
114159(G)	SC	AR	VOLKSWAGEN TRANSPORTER
114242(G)	SC	AR	AUDI 80 VOLKSWAGEN PASSAT1

SIAAM	Type de fixation / Mounting Type	Position	Modèle / Model
114288(G)	SC	AR	MATRA TALBOT BAGHEERA
114381(G)	SC	AR	HANOMAG HENSCHEL MERCEDES L
114395(G)	SC	AR	VOLVO 240 / 260
114429(G)	SC	AR	SUBARU LEONE
114473(G)	SC	AR	TOYOTA HI-LUX
114487(G)	SC	AR	TOYOTA PUBLICA
114517(G)	SC	AR	MAZDA 323
114520(G)	SC	AR	HYUNDAI EXCEL & PONY MITSUBISHI CELESTE / LANCER
114531(G)	SC	AR	MITSUBISHI GALANT
114532(G)	SC	AR	MITSUBISHI GALANT
114535(G)	SC	AR	TOYOTA LITEACE MITSUBISHI GALANT COLT
114536(G)	SC	AR	TOYOTA PUBLICA
114593(G)	SC	AR	LADA NIVA
114703(G)	SC	AR	MAZDA E MITSUBISHI DELICIA
114741(G)	SC	AR	PORSCHE 924 / 944
114780(G)	SC	AR	MERCEDES L
114781(G)	SC	AR	JEEP CHEROKEE RENAULT JEEP WILLYS CHEROKEE & WAGONEER
114786(G)	SC	AR	DAIHATSU FOURTRACK & ROCKY & TAFT & WILDACT MITSUBISHI GALANT COLT / GALANT - LAMBDA - SAPPORO - SIGMA / LANCER NISSAN SUNNY - SENTRA / VANETTE
114801(G)	SC	AR	FORD SIERRA
114802(G)	SC	AR	FORD ESCORT 3 & 4 VOLKSWAGEN CADDY 1 / GOLF 1
114829(G)	SC	AR	FIAT 131 SEAT131
114864(G)	SC	AR	HYUNDAI PONY / SCOUPE MITSUBISHI COLT & MIRAGE / CORDIA & TREDIA / LANCER / SPACE WAGON & SPACE VAN (CHARIOTT) & EXPO
114879(G)	SC	AR	MITSUBISHI GALANT
114917(G)	SC	AR	MITSUBISHI LANCER
114942(G)	SC	AR	CITROEN XSARA 1 & 2 / ZX PEUGEOT205 / 306 / 309
114946(G)	SC	AR	RENAULT SUPER 5
114970(G)	SC	AR	AUTOBIANCHI Y10 FIAT PANDA 1 LANCIA Y10
114972(G)	SC	AR	CITROEN AX / SAXO
114980(G)	SC	AR	RENAULT R5 EXPRESS
114984(G)	SC	AR	RENAULT R21
115024(G)	SC	AR	MITSUBISHI L-SERIES
115125(G)	SC	AR	VAUXHALL CAVALIER
115126(G)	SC	AR	NISSAN CHERRY
115136(G)	SC	AR	MITSUBISHI COLT - LANCER
115150(G)	SC	AR	PEUGEOT106

SIAAM	Type de fixation / Mounting Type	Position	Modèle / Model
115170(G)	SC	AR	FIAT CINQUECENTO / SEICENTO
115182(G)	SC	AR	RENAULT MASTER
115191(G)	SC	AR	FIAT PUNTO1
115200(G)	SC	AR	SEAT INCA VOLKSWAGEN CADDY 2 / POLO 3
115222(G)	SC	AR	FORD COURRIER
115257(G)	SC	AR	AUTOBIANCHI Y10 LANCIA Y10
115262(G)	SC	AR	VOLVO 440 / 460 / 480
115264(G)	SC	AR	FORD ESCORT 5 & 6
115286(G)	SC	AR	LANCIA Y.
115290(G)	SC	AR	RENAULT MÉGANE 1
115327(G)	SC	AR	FORD ESCORT 6
115332(G)	SC	AR	RENAULT MÉGANE 1
115337(G)	SC	AR	FORD GALAXY SEAT ALHAMBRA VOLKSWAGEN SHARA
115364(G)	SC	AR	TOYOTALITEACE-UMMALTER
115378(G)	SC	AR	FIAT MAREA
115408(G)	SC	AR	FIAT PUNTO 2
115437(G)	SC	AR	RENAULT MEGANE
115439(G)	SC	AR	RENAULT KANGOO EXCEPT 800KG
115463(G)	SC	AR	NISSAN KING CAB
115474(G)	SC	AR	OPEL AGILA SUZUKI WAGONR
115498(G)	SC	AR	FIAT PUNTO 2
115510(G)	GC	AR	MERCEDES "V" KLASSE
115512(G)	SC	AR	FORD FOCUS 1
115526(G)	SC	AR	SUZUKI JIMNY
115534(G)	SC	AR	OPEL ASTRA G
115535(G)	SC	AR	OPEL ASTRA G & H / ZAFIRA 2
115539(G)	SC	AR	MERCEDES A KLASSE
115555(G)	SC	AR	OPEL ZAFIRA 1 - VAUXHALL ZAFIRA
115590(G)	SC	AR	FIAT IDEA LANCIA MUSA / YPSILON 2
115592(G)	SC	AR	CITROEN C2 / C3 PH.1 / CLASSIC / PLURIEL PEUGEOT1007
115627(G)	SC	AR	OPEL COMBO / CORSA C / MERIVA
115631(G)	SC	AR	RENAULT LAGUNA 2
115656(G)	SC	AR	FIAT STILO BREAK
115660(G)	SC	AR	VOLKSWAGEN TRANSPORTER T5
115665(G)	SC	AR	OPEL AGILA 1 SUZUKI IGNIS/ WAGON R
115684(G)	SC	AR	FORD FOCUS 2 BREAK
115685(G)	SC	AR	FIAT CROMA 2 OPEL SIGNUM / VECTRA C
115693(G)	SC	AR	FIAT PANDA2
115700(G)	SC	AR	FORD EUROPE TRANSIT 4
115709(G)	SC	AR	FORD EUROPE TRANSIT 4
115718(G)	SC	AR	MERCEDES VITO

SIAAM	Type de fixation / Mounting Type	Position	Modèle / Model
115743(G)	GC	AR	NISSAN
115743(G)	SC	AR	NISSAN TRADE
115746(G)	SC	AR	FIAT 500 FORD KA2
115749(G)	SC	AR	FIAT PANDA 2 (4X4)
115752(G)	SC	AR	CITROEN NEMO FIAT FIORINO & FIORINO QUBO PEUGEOTBIPPER
115758(G)	SC	AR	VOLKSWAGEN CADDY 3
115763(G)	GC	AR	RENAULT KANGOO 2 EXPRESS
115769(G)	SC	AR	HYUNDAI ATOS
115778(G)	SC	AR	MERCEDES Vaneo
115811(G)	SC	AR	FORD EUROPE TRANSIT 4
115812(G)	SC	AR	FORD EUROPE TRANSIT 4
115824(G)	SC	AR	NISSAN QASHQAI
115845(G)	SC	AR	FIAT PANDA3
115850(G)	SC	AR	FORD EUROPE FOCUS 3
115905(G)	SC	AR	HYUNDAI I10
115916(G)	SC	AR	PEUGEOT301 CITROËN C-ELYSEE
115919(G)	GC	AR	KIA CERATO
118129(G)	SC	AR	ISUZU PICK UP
118668/(G)	SC	AR	FORD EUROPE RANGER
118672(G)	SC	AR	TOYOTA HI-LUX
121572(G)	SC	AV	AUTOBIANCHI ADRIA FIAT 133 / 850 SEAT 133 / 850
131126(G)	SC	AR	RENAULT R4 BERLINE / R6
131319(G)	GC	AR	FACEL VEGA EXCELLENCE
131499(G)	SC	AR	FACEL VEGA FACEL 3 & FACELLIA
131526(G)	SC	AR	DAF
131573(G)	SC	AR	AUTOBIANCHI ADRIA FIAT 133 / 850 SEAT 133 / 850
131678(G)	SC	AR	RENAULT R4 FOURGONNETTE / R5 / R6
134182(G)	SC	AR	MORRIS MARINA
134652(G)	SC	AR	OPEL KADETT D & E
141004(G)	SC	AV	OPEL REKORD / COMMODORE
141080(G)	SC	AV	RENAULT R4 / R5 / R6
141112(G)	SC	AR	RENAULT DAUPHINE / FLORIDE
141114(G)	SC	AV	DACIA 1100 RENAULT CARAVELLE / FLORIDE / R8 / R10
141116(G)	SC	AV	RENAULT DAUPHINE / FLORIDE / ONDINE
141118(G)	SC	AV	ALPINE RENAULT A 110 / A 110 B MATRA JET V & VS / JET VI RENAULT R8 / R10
141122(G)	SC	AV	RENAULT 4 CV
141125(G)	SC	AV	RENAULT R4 / R6
141134(G)	SC	AV	SIMCA ARONDE
141156(G)	SC	AV	CHRYSLER 900 - 1000 - 1000 E SIMCA 1000 / 1200
141319(G)	GC	AV	FACEL VEGA EXCELLENCE



SIAAM	Type de fixation / Mounting Type	Position	Modèle / Model
141388(G)	SC	AV	FIAT 600 / 850 / 900 / 1100 / 1200 / 1500
141408(G)	SC	AV	ALFAROMEIO GIULIA / GIULIETTA
141425(G)	SC	AV	CHRYSLER ESP
141496(G)	SC	AV	FIAT 1300-1500 POLSKI 125 P ZASTAVA 125 / 1300 & 1500
141498(G)	SC	AV	FACEL VEGA FACEL 3 & FACELLIA
141518(G)	SC	AV	FORD TAUNUS
141525(G)	SC	AR	SAAB 96 / 97 TOYOTA C SUZUKI JIMMY
141527(G)	SC	AV	MOSKVITCH 400 SÉRIES
141529(G)	SC	AV	VOLGA M21 & M24
141530(G)	SC	AV	OPEL KADETT A & B / OLYMPIA
141537(G)	SC	AV	ISUZU BELLET
141551(G)	SC	AV	LANCIA FLAVIA / FULVIA
141559(G)	SC	AV	SKODA 100>135 / 1 000 / OCTAVIA
141561(G)	SC	AV	HILLMAN MINX HUMBER SCEPTRE SINGER GAZELLE / VOGUE SUNBEAM RAPIER
141586(G)	SC	AV	NSU
141587(G)	SC	AV	DKW
141592(G)	SC	AV	SUNBEAM ALPINE
141600(G)	SC	AV	AUDI 60 / 70
141601(G)	SC	AV	FIAT 125 / 132 / ARGENTA POLONEZ CARO & CARGO / FSO / PICK UP & TRUCK POLSKI 132 P SEAT 132
141615(G)	SC	AV	TRIUMPH TR4 - TR5 - TR6 - TR250
141627(G)	SC	AV	VOLKSWAGEN 1200>1500
141628(G)	SC	AV	FIAT 124 SEAT 124
141664(G)	SC	AV	OPEL ADMIRAL / DIPLOMAT / KAPITAN
141668(G)	SC	AV	VOLVO P
141676(G)	SC	AV	ISUZU FLORIAN OPEL REKORD / COMMODORE
141697(G)	SC	AV	MERCEDES BENZ
141706(G)	SC	AR	OPEL COMMODORE - KADETT - OLYMPIA - REKORD VAUXHALL CHEVETTE
141721(G)	SC	AV	CHRYSLER 1200 SIMCA FRANCE 1100 TALBOT FRANCE 1100 / 1200
141751(G)	SC	AV	HINO CONTESSA
141761(G)	SC	AV	NISSAN CEDRIC-GLORIA / PRESIDENT TOYOTA CORONA / LITE ACE / STOUT
141773(G)	SC	AV	VAUXHALL FB
141806(G)	SC	AV	AUTOBIANCHI
141822(G)	SC	AV	DAIMLER JAGUAR
141839(G)	SC	AV	MAZDA 1500 / 1800
141884(G)	SC	AV	MERCEDES 200 > 450

SIAAM	Type de fixation / Mounting Type	Position	Modèle / Model
141910(G)	SC	AV	MERCEDES BENZ 300
141926(G)	SC	AV	VAUXHALL VIVA
141961(G)	SC	AV	OPEL ASCONA / MANTA
141980(G)	SC	AV	RENAULT R16
144034(G)	SC	AV	TRABANT 601
144034(G)	SC	AR	TRABANT 601
144072(G)	PLL	AV	TOYOTA HI-LUX VOLKSWAGEN TARO
144083(G)	SC	AV	BEDFORD MID ISUZU MIDI & FARGO & SETA MITSUBISHI L300 OPEL MIDI
144134(G)	SC	AV	ALFAROMEO ALFETTA / GIULIETTA
144259(G)	SC	AV	LADA KALINKA / VAZ
144260(G)	SC	AV	MERCEDES 200 > 450
144287(G)	SC	AV	MATRA BAGHEERA TALBOT BAGHEERA
144345(G)	SC	AV	CHRYSLERE 150 / SOLARA / ALPINE MATRA RANCHO SIMCA FRANCE 1100 SUNBEAM ALPINE TALBOT FRANCE 1100 AS / 1307 - 1308 - 1309 / 1510 / RANCHO / SOLARA
144357(G)	SC	AV	MAZDA B
144385(G)	SC	AV	ISUZU GEMINI / PIAZZA OPEL ASCONA B / KADETT C / MANTA VAUXHALL CAVALIER / CHEVETTE
144413(G)	SC	AV	OPEL KADETT
144472(G)	SC	AV	TOYOTA HI-LUX
144548(G)	SC	AV	CHRYSLER HORIZON TALBOT FRANCE HORIZON
144592(G)	SC	AV	LADA NIVA
144653(G)	SC	AV	SAAB 900
144702(G)	SC	AV	MAZDA E
144727(G)	SC	AV	NISSAN CEDRIC
144756(G)	SC	AV	TOYOTA LIT-ACE
144850(G)	SC	AV	BEDFORD KB ISUZU ELF FASTER / FASTER & RODEO / PICK UP / TROOPER & BIG HORN NISSAN CAB & KING CAB (PICK UP)
144870(G)	SC	AV	AUSTIN METRO ROVER 100
144956(G)	SC	AV	ALFAROMEO 75 / 90 / ALFETTA
145022(G)	SC	AV	FORD EUROPE RANGER
145023(G)	SC	AV	MITSUBISHI L-SERIES
145127(G)	SC	AV	KIA BESTA MAZDA E
145146(G)	SC	AV	DAF 200 FREIGHT ROVER SHERPA / SHERPA 200
145148(G)	SC	AR	DAIHATSU FEROZA & SPORTRACK / FOURTRACK & ROCKY & TAFT & WOLDACT
145177(G)	SC	AV	TATA

SIAAM	Type de fixation / Mounting Type	Position	Modèle / Model
145185(G)	SC	AV	MATRA MURENA TALBOT FRANCE MURENA
145208(G)	SC	AV	DAIHATSU FOURTRACK & ROCKY & TAFT & WILDACT
145300(G)	SC	AV	MERCEDES "E" KLASSE
145308(G)	SC	AV	MERCEDES "C" KLASSE
145462(G)	SC	AV	NISSAN KING CAB
145525(G)	SC	AV	SUZUKI JIMNY
145583(G)	SC	AV	RENAULT B SERIES
145694(G)	SC	AV	MERCEDES CLASSE E AVANTGARDE
148128(G)	SC	AV	ISUZU FASTER & RODEO / PICK UP
148220(G)	SC	AV	ISUZU PICK UP
148671(G)	SC	AV	TOYOTA HI - LUX
151014(G)	SC	AR	OPEL ADMIRAL / DIPLOMAT / KAPITAN / MONZA / SENATOR VAUXHALL ROYALE - SENATOR
151040(G)	SC	AR	OPEL ASCONA A / MANTA / REKORD VAUXHALL
151055(G)	SC	AR	NISSAN BLUEBIRD / LAUREL / VIOLET
151070(G)	SC	AR	FORD CONSUL / GRANDA
151110(G)	SC	AR	RENAULT DAUPHINE / FLORIDE / ONDINE
151121(G)	SC	AR	ALPINE RENAULT A110 RENAULT R8/R10
151123(G)	SC	AR	RENAULT 4CV
151137(G)	SC	AR	PANHARD DYNA / 24
151149(G)	SC	AR	FORD TAUNUS
151158(G)	SC	AR	SIMCA 1000
151372(G)	SC	AR	ALFA ROMEO GIULIETTA
151469(G)	SC	AR	VOLVO PV
151477(G)	SC	AR	NISSAN SUNNY SUZUKI JIMMY
151495(G)	SC	AR	AUSTIN MINI INNOCENTI MINI - 90 - 120 MORRIS MINI WOLSELEY HORNET
151520(G)	SC	AR	VOLGA
151539(G)	SC	AR	SIMCA 1300/1500
151541(G)	SC	AR	OPEL KADETT
151558(G)	SC	AR	HILLMAN IMP SINGER CHAMOIS SUNBEAM STILETTO
151585(G)	SC	AR	FORD TAUNUS
151588(G)	SC	AR	AUDI 60-70-90 DKW
151593(G)	SC	AR	SUNBEAM ALPINE
151602(G)	SC	AR	FIAT 125 POLSKI 125 P
151629(G)	SC	AR	FIAT 124 SEAT 124
151661(G)	SC	AR	TRIUMPH 1300
151685(G)	SC	AR	BMW 1502 --> 2202
151696(G)	SC	AR	MORRIS MINI

SIAAM	Type de fixation / Mounting Type	Position	Modèle / Model
151722(G)	SC	AR	CHRYSLER 1200 SIMCA 1100 / 1200 TALBOT FRANCE 1100 / 1200
151742(G)	SC	AR	FORD CORSAIR / CORTINA
151743(G)	SC	AR	DACIA 1100 RENAULT DAUPHINE / R8 / R10
151762(G)	SC	AR	FIAT 1100>1500 NISSAN BLUEBRID / VIOLET - AUSTER POLSKI 125 P TOYOTA COROLLA / CORONA MK I / CRESSIDA ZASTAVA 125 / 1300 & 1500
151801(G)	SC	AR	FIAT 124 / 131 / ARGENTA POLSKI 132 P SEAT 124 / 131 ZASTAVA 125
151804(G)	SC	AR	TOYOTA COROLLA
151844(G)	SC	AR	VAUXHALL FB
151863(G)	SC	AR	FORD CAPRI
151872(G)	SC	AR	JENSEN HEALEY VAUXHALL FIRENZA - MAGNUM - FD SERIES - VIVA HB - HC
151917(G)	SC	AR	AUDI 100
151976(G)	SC	AR	DAF
151991(G)	SC	AR	RENAULT R16
151992(G)	SC	AR	VAUXHALL VIVA
151996(G)	SC	AR	VOLKSWAGEN 411 / 412
151999(G)	SC	AR	CHRYSLER HUNTER HILLMAN HUNTER / MINX HUMBER SCEPTRE SUNBEAM ALPINE / RAPIER
151999(G)	SC	AR	CHRYSLER HUNTER HILLMAN HUNTER / MINX HUMBER SCEPTRE SUNBEAM ALPINE / RAPIER
154009(G)	SC	AR	AUSTIN MAESTRO VAN
154026(G)	SC	AR	ALFAROMEAL ALFA33 / ALFA SUD
154030(G)	SC	AR	RENAULT R19
154041(G)	SC	AR	RENAULT R19
154110(G)	SC	AR	FIAT 132 SEAT 132
154130(G)	SC	AR	DAIHATSU CHARMANT TOYOTA CARINA 1 / CELICA / COROLLA / CORONA / TERCEL
154211(G)	SC	AR	ALFA ROMEO ALFA SUD
154286(G)	SC	AR	NISSAN CHERRY
154297(G)	SC	AR	NISSAN SUNNY
154327(G)	SC	AR	ISUZU GEMINI OPEL KADETT C / REKORD / COMMODORE VAUXHALL CARLTON / CHEVETTE / VICEROY
154334(G)	SC	AR	DAIHATSU CHARMANT NISSAN SILVIA - GAZELLE TOYOTA COROLLA
154344(G)	SC	AR	FORDE SCORT 1 & 2
154346(G)	SC	AR	CHRYSLERE 150 / HORIZON / SOLARA / ALPINE SUNBEAM ALPINE TALBOT FRANCE 1307-1308-1309 / 1510 / HORIZON / SOLARA

SIAAM	Type de fixation / Mounting Type	Position	Modèle / Model
154354(G)	SC	AR	HILLMAN AVENGER SUNBEAM AVENGER TALBOT FRANCE AVENGER TOYOTA CARINA I / CELICA / COROLLA / CRESSIDA / STARLET
154356(G)	SC	AR	MAZDA 818 / RX3
154489(G)	SC	AR	OPEL ASCONA B / MANTA VAUXHALL CAVALIER / FE SERIES
154528(G)	SC	AR	MATRA RANCHO SIMCA FRANCE 1100 TALBOT FRANCE 1100 / RANCHO
154589(G)	SC	AR	TOYOTA CORONA / CRESSIDA
154607(G)	SC	AR	MAZDA 626 / 929
154611(G)	SC	AR	NISSAN SUNNY
154612(G)	SC	AR	NISSAN SUNNY TOYOTA COROLLA
154651(G)	SC	AR	OPEL KADETT- ASCONA
154654(G)	SC	AR	SAAB 90 / 99 / 900
154655(G)	SC	AR	INNOCENTI
154664(G)	SC	AR	TOYOTA STARLET / SUPRA
154680(G)	SC	AR	VAUXHALL FE
154686(G)	SC	AR	CHRYSLER AVENGER / SUNBREAM HILLMAN AVENGER SUNBEAM AVENGER TALBOT FRANCE SUNBREAM
154688(G)	SC	AR	AUSTIN MINI
154696(G)	SC	AR	MAZDA 121/RX5
154713(G)	SC	AR	NISSAN SUNNY
154755(G)	SC	AR	NISSAN SILVIA / VIOLET
154759(G)	SC	AR	MAZDA RX7
154777(G)	SC	AR	RENAULT R5
154791(G)	SC	AR	POLONEZ
154849(G)	SC	AR	CHEVROLET EUROPE AVEO / KALOS DAEWOO KALOS
154859(G)	SC	AR	TOYOTA TERCEL
154874(G)	SC	AR	RENAULT R9 / R11
154876(G)	SC	AR	NISSAN CEDRIC
154922(G)	SC	AR	DACIA SOLENZA
154925(G)	SC	AR	BMW 3E30
154933(G)	SC	AR	MERCEDES 190-->220 / 230-->250 / 260-->280 / 300-->320 / 350-->450 / "E" KLASSE
154935(G)	SC	AR	OPEL CORSA A & B VAUXHALL NOVA
154955(G)	SC	AR	FIAT UNO
154965(G)	SC	AR	RENAULT R9 / R11
155120(G)	SC	AR	OPEL OMEGA VAUXHALL CARLTON
155129(G)	SC	AR	ALFAROMEO ARNA NISSAN CHERRY / SUNNY
155130(G)	SC	AR	NISSAN VANETTE
155131(G)	SC	AR	OPEL OMEGA / SENATOR / VECTRA A VAUXHALL CARLTON / CAVALIER / ROYALE - SENATOR

SIAAM	Type de fixation / Mounting Type	Position	Modèle / Model
155132(G)	SC	AR	FORD SIERRA
155149(G)	SC	AR	DAEWOO ARANOS & CIELO & ESPERO / LANOS & SENS / NEXIA / RACER OPEL ASTRA F / KADETT E / VECTRA A VAUXHALL ASTRA / BELMONT / CAVALIER
155158(G)	SC	AR	OPEL ASTRA F VAUXHALL ASTRA
155181(G)	SC	AR	OPEL CALIBRA VAUXHALL CALIBRA
155186(G)	SC	AR	BMW 3E36
155192(G)	SC	AR	NISSAN MICRA 2
155203(G)	SC	AR	TOYOTA RAV 4
155207(G)	SC	AR	SUZUKI SANTANA / VITARA
155259(G)	SC	AR	SUZUKI SANTANA / VITARA
155275(G)	SC	AR	AUDI A3 SEAT LEON1 / TOLEDO 2 SKODA OCTAVIA 1 VOLKSWAGEN BORA / GOLF IV
155309(G)	SC	AR	MERCEDES "C" KLASSE
155313(G)	SC	AR	TOYOTA RAV 4
155363(G)	SC	AR	RENAULT CLIO2
155373(G)	SC	AR	AUDI A6 SKODA SUPERB 1 VOLKSWAGEN PASSAT 4 & 5
155404(G)	SC	AR	BMW 3E46
155411(G)	SC	AR	MERCEDES "E" KLASSE
155450(G)	GC	AR	RENAULT CLIO2
155464(G)	SC	AR	AUDI A3 SEAT LEON 1 / TOLEDO 2 SKODA OCTAVIA 1 VOLKSWAGEN BEETLE / BORA / GOLF IV
155467(G)	SC	AR	SEAT AROSA VOLKSWAGEN LUPO
155502(G)	SC	AR	AUDI A2 SKODA FABIA 1 & 2 VOLKSWAGEN POLO 4
155503(G)	SC	AR	AUDI A2 SKODA FABIA 1 & 2 VOLKSWAGEN POLO 4
155504(G)	SC	AR	SKODA OCTAVIA 1 / ROOMSTER VOLKSWAGEN BORA / GOLF IV
155511(G)	SC	AR	FORD FOCUS 1
155523(G)	SC	AR	TOYOTA YARIS 1
155524(G)	SC	AR	TOYOTA YARIS VERSO
155560(G)	SC	AR	OPEL CORSAC
155564(G)	SC	AR	AUDI A2 VOLKSWAGEN FOX
155567(G)	SC	AR	AUDI A1 SEAT CORDOBA 2 / IBIZA 4 & 5 SKODA FABIA VOLKSWAGEN POLO
155571(G)	SC	AR	OPEL CORSA C
155605(G)	SC	AR	FIAT GRANDE PUNTO / PUNTO EVO OPEL CORSA D

SIAAM	Type de fixation / Mounting Type	Position	Modèle / Model
155620(G)	SC	AR	BMW 3E46
155625(G)	SC	AR	FIAT BRAVO 2 / STILO LANCIA DELTA 3
155630(G)	SC	AR	BMW 3E46
155636(G)	SC	AR	NISSAN MICRA 2
155643(G)	SC	AR	FORD FIESTA 6 MAZDA 2
155647(G)	SC	AR	AUDI A4 SEAT EXEO
155648(G)	SC	AR	AUDI A4
155649(G)	SC	AR	AUDI A4
155662(G)	SC	AR	FORD FUSION
155669(G)	SC	AR	DACIA LOGAN / SANDERO
155673(G)	SC	AR	FORD C-MAX / FOCUS 2
155683(G)	SC	AR	MAZDA 3
155686(G)	SC	AR	SUZUKI GRAND VITARA
155687(G)	SC	AR	TOYOTA YARIS1
155698(G)	SC	AR	CITROEN C1 PEUGEOT107 TOYOTA AYGO
155707(G)	SC	AR	FORD FIESTA 7
155712(G)	SC	AR	RENAULT TWINGO 2
155715(G)	SC	AR	OPEL AGILA 2 SUZUKI SPLASH / SWIFT
155740(G)	SC	AR	MERCEDES "A" KLASSE / "B" KLASSE
155760(G)	SC	AR	HYUNDAI GETZ
155768(G)	SC	AR	TOYOTA YARIS 2
155773(G)	SC	AR	DACIA LOGAN
155781(G)	SC	AR	FIATS EDICI
155790(G)	SC	AR	FORD EUROPE C-MAX / FOCUS 3
155791(G)	SC	AR	ALFA ROMEO MITO
155814(G)	SC	AR	DACIA DUSTER
155854(G)	SC	AR	KIA PICANTO
155866(G)	GC	AR	OPEL ASTRA J
155874(G)	SC	AR	DACIA SANDERO 2
155875(G)	SC	AR	VOLKSWAGEN UP
155890(G)	SC	AR	HYUNDAI ACCENT III / VERNA II KIA RIO 2
155893(G)	SC	AR	DACIA LOGAN 2 / SANDERO 2
155904(G)	SC	AR	TOYOTA YARIS 3 XP 15 / VIOS
155907(G)	SC	AR	DACIA SANDERO STEPWAY 1
155950(G)		AR	RENAULT TWINGO 3
155963(G)		AR	OPEL ADAM
161141(G)	SC	AV	FORD VEFETTE
161163(G)	SC	AV	SIMCA FRANCE 1300 / 1500
161320(G)	SC	AV	VAUXHALL CRESTA
161330(G)	SC	AV	OPEL BLITZ
161350(G)	SC	AV	AUTOBIANCHI 264 & 320 / BIANCHINA / GIARDINIERA / LUTECE FIAT 126 / 500 / 600 POLSKI 126 P

SIAAM	Type de fixation / Mounting Type	Position	Modèle / Model
161371(G)	SC	AV	ALFA ROMEO GIULIETTA
161403(G)	SC	AV	VAUXHALL VICTOR
161404(G)	SC	AV	VOLVO P
161460(G)	SC	AV	VOLVO P
161521(G)	SC	AV	VAUXHALL FB
161544(G)	SC	AV	FIAT 500-->1600 ZASTAVA 750
164350(G)	SC	AR	MAZDA 818 NISSAN PATROL
171119(G)	SC	AR	RENAULT ESTAFETTE
171120(G)	SC	AR	RENAULT AMIRAL / DOMAINE / FREGATE / GRANDA PAVOIS / MANOIRS
171135(G)	SC	AR	SIMCA FRANCE ARONDE
171142(G)	SC	AR	FORD VEDETTE
171150(G)	SC	AR	CHRYSLER 900-1000-1000 E SIMCA FRANCE 1000 / 1200
171164(G)	SC	AR	SIMCA FRANCE 1300 / 1500
171327(G)	SC	AR	VAUXHALL VICTOR
171361(G)	SC	AR	AUTOBIANCHI 264 & 320 / BIANCHINA / GIARDINIERA / LUTECE FIAT 126 / 500 POLSKI 126 P
171363(G)	SC	AR	VOLVO P
171386(G)	SC	AR	FIAT 600 SEAT 600 D-800 ZASTAVA 750
171408(G)	SC	AR	ALFA ROMEO GIULIA / GIULIETTA
171471(G)	SC	AR	VOLVO P
171522(G)	SC	AR	VAUXHALL FB
171536(G)	SC	AR	VAUXHALL CRESTA
171562(G)	SC	AR	INNOCENTI
171619(G)	SC	AR	TRIUMPH
171624(G)	SC	AR	ROVER
171632(G)	SC	AR	NSU
171636(G)	SC	AR	ALFA ROMEO GIULIA / GIULIETTA / SPIDER
171667(G)	SC	AR	FORD EUROPE TAUNUS
171703(G)	SC	AR	FIAT 600 / 850 / 900
171749(G)	SC	AR	VAUXHALL VIVA
171829(G)	SC	AR	SAAB 99 SKODA 100>135 / 1000
174135(G)	SC	AR	ALFA ROMEO ALFETTA - GIULIETTA
174185(G)	SC	AR	DACIA 1300 RENAULT R12 / R15 / R17
174320(G)	SC	AR	NISSAN CHERRY
174358(G)	SC	AR	MAZDA 1500 / 1800 / B SKODA 130
174362(G)	SC	AR	MAZDA 929 / RX4
174393(G)	SC	AR	DAF 46 VOLVO 66 --> 960
174502(G)	SC	AR	DACIA R18 RENAULT R18 / FUEGO



SIAAM	Type de fixation / Mounting Type	Position	Modèle / Model
174668(G)	SC	AR	VOLVO 340 / 360
174678(G)	SC	AR	TRIUMPH TR7 / TR8
174750(G)	SC	AR	MAZDA 929
174762(G)	SC	AR	MAZDA 323
174848(G)	SC	AR	RENAULT MASTER
174957(G)	SC	AR	ALFA ROMEO 75 / 90 / ALFETTA
175354(G)	SC	AR	RENAULT MASTER
175757(G)	GC	AR	BMW 1E80 / 3E90
201043(G)	GC	AV	FORD TRANSIT1
201092(G)	GC	AV	MERCEDES L HANOMAG HENSCHEL
201478(G)	GC	AV	LAND ROVER
201498(G)	GC	AR	MERCEDES L
201545(G)	GC	AV	CITROEN 2CV / DYANE / AMI
201688(G)	GC	AV	JAGUAR E TYPE
201781(G)	GC	AV	MERCEDES L
201781(G)	GC	AR	MERCEDES L
201800(G)	GC	AV	FIAT 238
201891(G)	GC	AV	LAND ROVER
201896(G)	GC	AV	CITROEN H
204021(G)	GC	AV	MERCEDES L
204051(G)	GC	AV	FIAT DAILY 1
204192(G)	GC	AV	FORD CONSUL / CORTINA / GRANADA / TAUNUS HYUNDAI STELLAR
204213(G)	GC	AV	ARO (4X4)
204213(G)	GC	AR	ARO (4X4)
204364(G)	GC	AV	CITROEN C32 / C35 FIAT 242
204478(G)	GC	AV	CITROEN 2CV / ACADIANE / AMI
204478(G)	GC	AR	CITROEN 2CV / ACADIANE / AMI
204552(G)	GC	AV	TOYOTA LAND CRUISER / COASTER / DYNA
204587(G)	GC	AR	BEDFORD CF HYUNDAI H100 ISUZU LIGHT ELF / ELF FASTER MAZDA A --> Z NISSAN BLUEBIRD U TOYOTA COASTER / CORONA MK I / CORONA MK II / DYNA / HI-ACE / HI-LUX / LITE-ACE / STOUT
204891(G)	GC	AV	RENAULT JEEP (4X4 ) WILLYS LAREDO & RENEGADE
204908(G)	FU	AV	VOLKSWAGEN GOLF 2
204908(G)	GC	AV	FIAT DAILY 1 & 2
204969(G)	GC	AV	FIAT DAILY 89-99
205119(G)	GC	AV	FREIGHT ROVER SHERPA
205151(G)	GC	AV	DAF 400
205171(G)	GC	AV	MERCEDES MB
205355(G)	GC	AV	UMM ALTER
205461(G)	GC	AV	RENAULT MASTER
205461(G)	GC	AV	RENAULT MASTER OPEL MOVANO
205585(G)	GC	AV	OPEL MOVANO RENAULT MASTER

SIAAM	Type de fixation / Mounting Type	Position	Modèle / Model
211012(G)	GC	AR	OPEL BLITZ
211044(G)	GC	AR	FORD TRANSIT1
211096(G)	GC	AR	PEUGEOT504
211501(G)	GC	AR	CITROEN 2CV / DYANE
211513(G)	GC	AR	CITROËN H
211565(G)	GC	AR	PEUGEOT404
211765(G)	GC	AR	NISSAN CAB / CEDRIC TOYOTA CROWN / HI-LUX / LAND CRUISER VOLVO A-->Z
211862(G)	GC	AR	FORD TRANSIT
211897(G)	GC	AR	CITROËN H
211911(G)	GC	AR	FIAT 238
211981(G)	GC	AR	CITROËN 180K
214006(G)	GC	AR	FORD MAVERICK NISSAN PATHFINDER / TERRANO
214010(G)	GC	AR	JEEP CHEROKEE RENAULT JEEP WILLYS CHEROKEE & WAGONEER
214015(G)	GC	AR	CITROEN AX / SAXO
214023(G)	GC	AR	FIAT DAILY2
214031(G)	GC	AR	PEUGEOT405
214052(G)	GC	AR	FIAT DAILY 1 & 2
214055(G)	GC	AR	RENAULT CLIO1
214057(G)	GC	AR	PORSCHE 944
214064(G)	GC	AR	NISSAN PATROL
214070(G)	GC	AR	BEDFORD MIDI ISUZU MIDI & FARGO & SETA MITSUBISHI L-SERIES OPEL MIDI
214074(G)	GC	AR	TOYOTA HI-LUX VOLKSWAGEN TARO
214076(G)	GC	AR	TOYOTA HI-LUX VOLKSWAGEN TARO
214082(G)	GC	AR	MITSUBISHI L-SERIES
214086(G)	GC	AR	MITSUBISHI L300
214218(G)	GC	AR	TOYOTA CROWN
214244(G)	GC	AR	BEDFORD CF OPEL BLITZ
214365(G)	GC	AR	CITROEN C32 / C35 FIAT 242
214537(G)	GC	AR	FORD TRANSIT1
214636(G)	GC	AR	CITROEN ACADIANE
214757(G)	GC	AR	TOYOTA LITE ACE
214809(G)	GC	AR	CITROEN C25 FIAT DUCATO / TALENTO PEUGEOTJ5-->J9 TALBOT U.K UTILITAIRES / COMMERCIALS
214875(G)	GC	AR	PEUGEOT505
214880(G)	GC	AR	BEDFORD CF / KB EBRO JEEP COMMANDO MITSUBISHI PAJERO - MONTERO - SHOGUN (4X4) RENAULT JEEP (4X4) WILLYS LAREDO & RENEGADE / UNIVERSAL JEEP

SIAAM	Type de fixation / Mounting Type	Position	Modèle / Model
214892(G)	GC	AR	ARO (4X4)
214921(G)	GC	AR	MINI GALANT / LAMBDA / SAPPORO / SIGMA NISSAN VIOLET / AUSTER
214930(G)	GC	AR	VOLKSWAGEN TRANSPORTER
214937(G)	GC	AR	RENAULT SUPER5
214939(G)	GC	AR	VOLKSWAGEN TRANSPORTER
214940(G)	GC	AR	CITROEN XSARA 1 & 2 / ZX PEUGEOT205 / 306 / 309
214953(G)	GC	AR	FORD SCORPIO
214963(G)	GC	AR	CITROEN C25 FIAT DUCATO / TALENTO PEUGEOTJ5-->J9 TALBOT U.K UTILITAIRES / COMMERCIALS
214994(G)	GC	AR	IVECO DAILY 35.10-49.10
214997(G)	GC	AR	RENAULT R21
215013(G)	GC	AR	ISUZU D-MAX
215020(G)	GC	AR	TOYOTA HI-LUX
215021(G)	GC	AR	FORD EUROPE RANGER
215028(G)	GC	AR	TOYOTA HI-ACE
215031(G)	GC	AR	TOYOTA HI-ACE
215101(G)	GC	AR	RENAULT CLIO1
215110(G)	GC	AR	FREIGHT ROVER SHERPA
215113(G)	GC	AR	FORD MAVERICK NISSAN PATHFINDER / TERRANO
215117(G)	GC	AR	RENAULT TRAFIC 1
215124(G)	GC	AR	PEUGEOT605
215138(G)	GC	AR	DAF 200 FREIGHT ROVER SHERPA 200
215145(G)	GC	AR	FREIGHT ROVER SHERPA
215152(G)	GC	AR	DAF 400
215160(G)	GC	AR	ALFA ROMEO 145 / 146 / 155 FIAT BRAVA / BRAVO 1 / COUPE / PALIO / TEMPRA / TIPO LANCIA DEDRA / DELTA
215161(G)	GC	AR	PEUGEOT106
215162(G)	GC	AR	CITROEN SAXO PEUGEOT106
215168(G)	GC	AR	TOYOTA HI-ACE
215172(G)	GC	AR	MERCEDES UTILITAIRES / COMMERCIALS
215176(G)	GC	AR	TOYOTA HI-ACE
215178(G)	GC	AR	TATA
215188(G)	GC	AR	RENAULT LAGUNA 1
215194(G)	GC	AR	TATA
215204(G)	GC	AR	MINI PAJERO
215220(G)	GC	AR	FORD TRANSIT 3
215227(G)	GC	AR	FORD MONDEO 1
215231(G)	GC	AR	FORD TRANSIT 3
215232(G)	GC	AR	RENAULT R5 EXPRESS
215234(G)	GC	AR	RENAULT LAGUNA 1 / NEVADA
215238(G)	GC	AR	MERCEDES SPRINTER VOLKSWAGEN LT-SERIES

SIAAM	Type de fixation / Mounting Type	Position	Modèle / Model
215243(G)	GC	AR	CITROEN JUMPER FIAT DUCATO PEUGEOTBOXER
215261(G)	GC	AR	NISSAN PICK UP / JUNIOR
215288(G)	GC	AR	RENAULT ESPACE 3
215292(G)	GC	AR	CITROEN BERLINGO 1 PEUGEOTPARTNER 1
215296(G)	GC	AR	CITROEN JUMPY FIAT SCUDO PEUGEOTEXPERT
215298(G)	GC	AR	CHRYSLER VOYAGER 1
215318(G)	GC	AR	FIAT MAREA / MARENGO / TEMPRA
215321(G)	GC	AR	KIA BESTA OPEL FRONTERA A VAUXHALL FRONTERA
215352(G)	GC	AR	RENAULT ESPACE 3
215356(G)	GC	AR	UMM ALTER
215375(G)	GC	AR	CHRYSLER VOYAGER 2
215406(G)	GC	AR	FIAT MULTIPLA
215430(G)	SC	AR	NISSAN KUBISTAR RENAULT KANGOO 1
215436(G)	SC	AR	RENAULT SCENIC1
215465(G)	GC	AR	NISSAN INTERSTAR OPEL MOVANO RENAULT MASTRE
215466(G)	GC	AR	OPEL MOVANO RENAULT MASTER
215468(G)	GC	AR	CITROEN EVASION FIAT ULYSSE 1 LANCIA ZETA PEUGEOT806
215475(G)	GC	AR	CITROEN JUMPY FIAT SCUDO PEUGEOTEXPERT
215484(G)	GC	AR	PEUGEOT206
215485(G)	GC	AR	PEUGEOT206 / 206+
215486(G)	GC	AR	PEUGEOT206
215487(G)	GC	AR	PEUGEOT206
215494(G)	GC	AR	MAZDA E
215527(G)	GC	AR	RENAULT MÉGANE 1
215530(G)	GC	AR	RENAULT SCENIC 1
215537(G)	GC	AR	NISSAN TRADE
215544(G)	GC	AR	CITROEN PICASSO
215561(G)	GC	AR	FIAT DOBLÒ 1
215589(G)	GC	AR	NISSAN KUBISTAR RENAULT KANGOO 1
215597(G)	GC	AR	NISSAN PRIMASTAR OPEL VIVARO RENAULT TRAFIC 2 / TRAFIC 3
215598(G)	GC	AR	LANCIA DEBRA BREAK
215601(G)	GC	AR	PEUGEOT207
215621(G)	GC	AR	PEUGEOT206 SW
215623(G)	GC	AR	RENAULT MÉGANE 2 & 3 / SCENIC 2 & 3

SIAAM	Type de fixation / Mounting Type	Position	Modèle / Model
215637(G)	GC	AR	RENAULT LAGUNA 2
215638(G)	GC	AR	RENAULT LAGUNA 3
215639(G)	GC	AR	MERCEDES SPRINTER VOLKSWAGEN LT
215651(G)	GC	AR	NISSAN CAB & KING CAB
215653(G)	GC	AR	OPEL ASTRA H
215678(G)	GC	AR	CITROEN C8 FIAT ULYSSE 2 LANCIA PHEDRA PEUGEOT807
215690(G)	GC	AR	RENAULT KANGOO 1
215714(G)	GC	AR	RENAULT MÉGANE 2
215722(G)	GC	AR	RENAULT ESPACE 4
215724(G)	GC	AR	RENAULT GRAND SCENIC 2
215725(G)	SC	AR	PEUGEOT207
215748(G)	GC	AR	FIAT DOBLÒ 1
215761(G)	GC	AR	RENAULT LAGUNA 3
215776(G)	GC	AR	CITROEN C3 PICASSO
215797(G)	GC	AR	PEUGEOT607
215803(G)	GC	AR	FIAT DOBLO 2
215819(G)	GC	AR	CITROEN DS3
215827(G)	GC	AR	RENAULT KOLEOS
215831(G)	GC	AR	PEUGEOT5008
215840(G)	GC	AR	CITROËN JUMPY & DISPATCH FIAT SCUDO PEUGEOTEXPERT
215844(G)	GC	AR	OPEL MERIVA
215851(G)	GC	AR	CITROËN JUMPY & DISPATCH FIAT SCUDO PEUGEOTEXPERT
215853(G)	GC	AR	RENAULT SCENIC 3
215856(G)	GC	AR	RENAULT FLUENCE
215860(G)	GC	AR	CITROËN C4 PICASSO
215871(G)	GC	AR	CITROËN BERLINGO / C4 PICASSO PEUGEOTPARTNER & RANCH
215872(G)	GC	AR	CITROËN BERLINGO PEUGEOTPARTNER & RANCH
215880(G)	GC	AR	DACIA DOKKER
215885(G)	GC	AR	PEUGEOT208
215886(G)	GC	AR	PEUGEOT208
215888(G)	GC	AR	DACIA LODGY
215894(G)	GC	AR	MERCEDES SPRINTER 2 VOLKSWAGEN CRAFTER
215895(G)	GC	AR	MERCEDES SPRINTER 2 VOLKSWAGEN CRAFTER
215937(G)	GC	AR	TOYOTA HI-LUX KUN 15 - 16 4x2
215977(G)	GC	AR	TOYOTA RAV 4 III
218699(G)	GC	AR	MITSUBISHI L-SERIES
231479(G)	GC	AR	LANDROVER 109 / 119
231892(G)	GC	AR	LAND ROVER (4X4)
234603(G)	GC	AR	NISSAN PATROL

SIAAM	Type de fixation / Mounting Type	Position	Modèle / Model
235026(G)	GC	AR	TOYOTA HI-ACE
235029(G)	GC	AR	TOYOTA HI-ACE
241011(G)	GC	AV	OPEL BLITZ
241344(G)	GC	AV	DAIMLER 2.5 L JAGUAR 240 & 340 / MK II / DAIMLER JENSEN INTERCEPTER
241756(G)	GC	AV	DAIMLER SOVEREIGN JAGUAR S TYPE / 420 / MK X / DAIMLER SOVEREIGN
241763(G)	GC	AV	TOYOTA CROWN
241782(G)	GC	AV	MERCEDES L
244019(G)	GC	AV	JEEP CHEROKEE RENAULT JEEP WILLYS CHEROKEE & WAGONEER
244065(G)	GC	AV	BEDFORD CF
244088(G)	GC	AV	MINIBUS MITSUBISHI L-SERIES NISSAN URVAN TOYOTA DYNA / HI-ACE
244515(G)	GC	AV	ALPINE RENAULT R5 RENAULT R5 ALPINE
244586(G)	GC	AV	MINIBUS MITSUBISHI DELICIA / FORTE TOYOTA HI-ACE / HI-LUX
244683(G)	GC	AV	TOYOTA CROWN
244826(G)	GC	AV	VOLKSWAGEN LT
244861(G)	GC	AV	ISUZU ELF / LIGHT ELF TOYOTA DYNA
244894(G)	GC	AV	TOYOTA LANDCRUISER
244991(G)	GC	AV	MINIBUS MITSUBISHI PAJERO
245010(G)	GC	AR	ISUZU D-MAX
245010(G)	GC	AV	FORD EUROPE RANGER
245012(G)	GC	AV	ISUZU D-MAX
245025(G)	GC	AV	TOYOTA HI-ACE
245027(G)	GC	AV	TOYOTA HI-ACE
245032(G)	GC	AV	HYUNDAI H100
245112(G)	GC	AV	DAEWOO KORANDO FORD MAVERICK / PATHEFINDER / TERRANO SSANGYONG KORANDO
245112(G)	GC	AV	DAEWOO KORANDO FORD EUROPE MAVERICK (4X4) NISSAN PATHFINDER (4X4) / TERRANO SSANGYONG 4X4 KORANDO
245167(G)	GC	AV	TOYOTA HI-ACE
245250(G)	GC	AV	NISSAN PICK UP / JUNIOR
245513(G)	GC	AV	OPEL FRONTERA B VAUXHALL FRONTERA
245536(G)	GC	AV	NISSAN TRADE
245581(G)	GC	AV	RENAULT B-SERIES
245640(G)	GC	AV	NISSAN CAB & KING CAB
245742(G)	SC	AV	NISSAN
245742(G)	GC	AV	NISSAN TRADE
251075(G)	GC	AR	BMW 1502 --> 2202
251078(G)	GC	AR	ISUZU FLORIAN
251596(G)	GC	AR	PEUGEOTJ7 / J9

SIAAM	Type de fixation / Mounting Type	Position	Modèle / Model
251622(G)	GC	AR	RENAULT GOELETTE / VOLIGEUR
251626(G)	GC	AR	PORSCHE 911
251698(G)	GC	AR	MERCEDES 190>300
251710(G)	GC	AR	MERCEDES 190>230
251752(G)	GC	AR	HINO CONTESSA
251974(G)	GC	AR	CHRYSLER 180 TALBOT 160/180
254106(G)	GC	AR	PORSCHE 911 / 930
254113(G)	GC	AR	SIMCA 1000
254151(G)	GC	AR	BMW 2500 --> 3300
254293(G)	GC	AR	RENAULT R5 / R14
254328(G)	GC	AR	OPEL REKORD / COMMODORE VAUXHALL CARLTON
254398(G)	GC	AR	MERCEDES 190-->220 / 230-->250 / 260-->280 / 300-->320 / 350-->450 / 500-->600
254414(G)	GC	AR	OPEL KADETT
254433(G)	GC	AR	TOYOTA CORONA / CROWN
254484(G)	GC	AR	PEUGEOT504 / 505 / 604 TALBOT FRANCE TAGORA
254516(G)	GC	AR	ALPINE RENAULT R5 RENAULT R5 ALPINE
254772(G)	GC	AR	AUDI 100 / 200
254873(G)	GC	AR	RENAULT TRAFIC 1
254962(G)	GC	AR	RENAULT TRAFIC 1
254967(G)	GC	AR	TOYOTA CELICA
254995(G)	GC	AR	OPEL CORSA A & B / TIGRA VAUXHALL NOVA / TIGRA
255254(G)	GC	AR	BMW 3E36 COMPACT
255258(G)	GC	AR	BMW 3E36
255273(G)	GC	AR	OPEL CALIBRA VAUXHALL CALIBRA
255316(G)	GC	AR	PEUGEOT406
255317(G)	GC	AR	PEUGEOT406
255478(G)	GC	AR	PEUGEOT406 COUPÉ
255500(G)	GC	AR	PEUGEOT307
255514(G)	GC	AR	OPEL FRONTERA B VAUXHALL FRONTERA
255554(G)	GC	AR	DAEWOO KORANDO SSANGYONG KORANDO
255579(G)	GC	AR	FIAT PALIO / SIENA
255582(G)	GC	AR	RENAULT B-SERIES
255584(G)	SC	AR	RENAULT B-SERIES
255587(G)	GC	AR	MITSUBISHI PAJERO
255596(G)	GC	AR	CITROEN C4 PEUGEOT307
255603(G)	JFG	AVG	CITROEN NEMO FIAT FIORINO / GRANDE PUNTO / LINEA / PUNTO PEUGEOTBIPPER
255613(G)	GC	AR	AUDI A3 SEAT ALTEA / LEON 2 / TOLEDO 3

SIAAM	Type de fixation / Mounting Type	Position	Modèle / Model
255615(G)	GC	AR	CITROEN C4 PEUGEOT307 / 308
255616(G)	GC	AR	VOLKSWAGEN TOURAN
255657(G)	GC	AR	KIA CARNIVAL
255659(G)	GC	AR	SSONGYONG MUSSO
255659(G)	GC	AR	SSANGYONG MUSSO
255675(G)	GC	AR	RENAULT CLIO 3 / MODUS / GRAND MODUS
255734(G)	GC	AR	AUDI A6
255741(G)	GC	AR	FORD GALAXY 2 / MONDEO 4 / S-MAX
255765(G)	GC	AR	VOLKSWAGEN EOS
255783(G)	GC	AR	AUDI A4 / A5
255788(G)	GC	AR	PEUGEOT308
255793(G)	GC	AR	SKODA YETI
255818(G)	GC	AR	PEUGEOT3008
255836(G)	GC	AR	SEAT ALHAMBRA VOLKSWAGEN SHARAN2
255839(G)	GC	AR	CITROEN C4 / DS4
255858(G)	GC	AR	VOLKSWAGEN TIGUAN
255859(G)	GC	AR	VOLKSWAGEN TIGUAN
255869(G)	GC	AR	OPEL INSIGNIA
255877(G)	GC	AR	RENAULT CLIO 4
255958(G)		AR	OPEL MOKKA
255974(G)	GC	AR	NISSAN JUKE
261168(G)	GC	AV	RENAULT ESTAFETTE
261621(G)	GC	AV	RENAULT GOELETTE / VOLIGEUR
264243(G)	GC	AV	BEDFORD CF OPEL BLITZ
271345(G)	GC	AR	DAIMLER 2.5 L JAGUAR 240 & 340 / MK II / DAIMLER
271675(G)	GC	AR	PEUGEOT404 / 504
274844(G)	GC	AR	ROVER 2000 / 2300
275834(G)	GC	AR	BMW Z4
275835(G)	GC	AR	BMW X1
311757(G)	SR	AR	DAIMLER SOVEREIGN JAGUAR S TYPE / 420 / MK X / DAIMLER SOVEREIGN
311823(G)	SR	AR	DAIMLER SOVEREIGN JAGUAR XJ6 / XJ12 / DAIMLER DOUBLE SIX / DAIMLER SOVEREIGN
314005(G)	SR	AR	FORD ESCORT 4 / ORION
314045(G)	SR	AR	FORD FIESTA 3
314099(G)	SR	AR	FORD FIESTA 3
315187(G)	SR	AR	FORD ESCORT 5 / ORION
315210(G)	SR	AR	FORD FIESTA 4
315221(G)	SR	AR	FORD FIESTA 4
315266(G)	SR	AR	FORD ESCORT 5
334721(G)	JFG	AVG	BMW Z4 -(E89)
334722(G)	JFD	AVD	BMW Z4 -(E89)
341073(G)	SR	AV	PEUGEOTJ7 / J9
344093(G)	SR	AV	PEUGEOTJ9
344094(G)	SR	AV	RENAULT MASTER



SIAAM	Type de fixation / Mounting Type	Position	Modèle / Model
344849(G)	SR	AV	RENAULT MASTER
345014(G)	SR	AV	ISUZU D-MAX
345276(G)	SR	AV	AUDI A4 / A6 VOLKSWAGEN PASSAT 4
345372(G)	SR	AV	AUDI A4 / A6 VOLKSWAGEN PASSAT 4
345644(G)	SR	AV	AUDI A4 SEAT EXEO
345645(G)	SR	AV	AUDI A4
345646(G)	SR	AV	AUDI A4
345667(G)	SR	AV	AUDI A6 SKODA SUPERB 1 VOLKSWAGEN PASSAT 5
345679(G)	SR	AV	CITROEN C5 PEUGEOT407
345680(G)	SR	AV	AUDI A6 SKODA SUPERB 1 VOLKSWAGEN PASSAT 5
345731(G)	SR	AV	AUDI A6
345732(G)	SR	AV	AUDI A6
345935(G)	SRG	AVG	TOYOTA HI-LUX
345936(G)	SRD	AVD	TOYOTA HI-LUX
348698(G)	SR	AV	MITSUBISHI NEW L200
349331(G)	SR	AV	TOYOTA HI-LUX NM 2004
351086(G)	SR	AR	BMW 2500 --> 3300
351717(G)	SR	AR	PEUGEOT204 / 304
354014(G)	SR	AR	HONDA CIVIC & BALLADE / CONCERTO --> Z
354033(G)	SR	AR	LADA 110 / 111 / 112 / DIVA / KALINA / NATACHA & RIVA & SAGONA / SAMARA
354127(G)	SR	AR	AUDI 80
354150(G)	SR	AR	PEUGEOT204 / 304
354194(G)	SR	AR	PEUGEOT104
354374(G)	SR	AR	VOLKSWAGEN GOLF 1, SCIROCCO
354448(G)	SR	AR	BMW 5E12 / 2500>3300
354469(G)	SR	AR	BMW 3E21
354493(G)	SR	AR	AUDI 50 VOLKSWAGEN DERBY / POLO 1 & 2
354504(G)	SR	AR	PEUGEOT104
354508(G)	SR	AR	PEUGEOT305
354580(G)	SR	AR	CITROEN VISA PEUGEOT104 TALBOT FRANCE SAMBA
354619(G)	SR	AR	PEUGEOT304
354620(G)	SR	AR	AUDI 80 / 90 / COUPÉ
354627(G)	SR	AR	CITROEN VISA PEUGEOT104
354681(G)	SR	AR	VOLKSWAGEN GOLF 1 / JETTA 1 / SCIROCCO
354711(G)	SR	AR	CITROEN LN / LNA
354771(G)	SR	AR	BMW 5E12 / 6E24
354787(G)	SR	AR	AUDI 100 / 200 / A6
354800(G)	SR	AR	AUDI A --> Z

SIAAM	Type de fixation / Mounting Type	Position	Modèle / Model
354806(G)	SR	AR	VOLKSWAGEN PASSAT 2 / SANTANA
354808(G)	SR	AR	BMW 5E28 / 6E24
354883(G)	SR	AR	CITROEN LN
354910(G)	SR	AR	AUDI A6
354912(G)	SR	AR	VOLKSWAGEN PASSAT 2 / SANTANA
354918(G)	SR	AR	PEUGEOT305
354927(G)	SR	AR	AUDI A --> Z
354952(G)	SR	AR	SEAT TOLEDO 1 VOLKSWAGEN GOLF 2 & 3 / GOLF CABRIOLET / JETTA 2 / VENTO ZASTAVA YUGO
354985(G)	SR	AR	PEUGEOT305
355108(G)	SR	AR	AUDI 80
355111(G)	SR	AR	CITROEN C15 PEUGEOT305 BREAK
355135(G)	SR	AR	VOLKSWAGEN PASSAT 3
355180(G)	SR	AR	RENAULT TWINGO 1
355184(G)	SR	AR	NISSAN MICRA1
355213(G)	SR	AR	BMW 5E34
355226(G)	SR	AR	VOLKSWAGEN GOLF 3
355230(G)	SR	AR	SKODA FAVORIT / FELICIA / FORMAN
355237(G)	SR	AR	SEAT CORDOBA 1 / IBIZA 2
355242(G)	SR	AR	SEAT CORDOBA 1 / IBIZA 2 VOLKSWAGEN POLO 3
355270(G)	SR	AR	OPEL VECTRA B VAUXHALL VECTRA
355277(G)	SR	AR	AUDI A4
355281(G)	SR	AR	OPEL VECTRA B VAUXHALL VECTRA
355283(G)	SR	AR	TOYOTA PASEO / STARLET
355320(G)	SR	AR	FORD FIESTA 5 / PUMA MAZDA 121
355325(G)	SR	AR	FORD ESCORT 6
355326(G)	SR	AR	FORD ESCORT 6
355339(G)	SR	AR	FORD KA 1
355353(G)	SR	AR	AUDI 100 / 200 / A6
355362(G)	SR	AR	ROVE R25 / 200
355381(G)	SR	AR	NISSAN ALMERA
355470(G)	SR	AR	FORD ESCORT 6
355479(G)	SR	AR	FORD FIESTA 5 / PUMA MAZDA 121
355481(G)	SR	AR	FORD ESCORT 6
355499(G)	SR	AR	AUDI A4
355538(G)	SR	AR	SEAT CORDOBA 1 / IBIZA 3 VOLKSWAGEN POLO
355545(G)	SR	AR	FORD KA 1
355546(G)	SR	AR	FORD KA 1
355548(G)	SR	AR	ROVER 200
355670(G)	SR	AR	CITROEN C5 PEUGEOT407
355733(G)	GC	AR	AUDI A6

SIAAM	Type de fixation / Mounting Type	Position	Modèle / Model
355969(G)	SR	AR	TOYOTA COROLLA E140 J
355971(G)	SR	AR	TOYOTA COROLLA VERSO (E12) (GB)
364188(G)	SR	AV	DACIA 1300 RENAULT R12 / R15 / R17
364399(G)	SR	AV	RENAULT R20 / R30
364501(G)	SR	AV	DACIA R18 RENAULT R18
364795(G)	SR	AV	RENAULT R18 / FUEGO
364814(G)	SR	AV	RENAULT R18
364847(G)	SR	AV	RENAULT R20 / R30
364865(G)	SR	AV	RENAULT R20 / R30
364920(G)	SR	AV	RENAULT R25
364973(G)	SR	AV	RENAULT R25
365116(G)	SR	AV	RENAULT ESPACE 1
365154(G)	SR	AV	RENAULT ESPACE 2
441009(G)	FU	AV	TOYOTA CELICA
441704(G)	FU	AV	TOYOTA COROLLA
441740(G)	FU	AV	PEUGEOT404
441770(G)	FU	AV	FORD CORTINA
441772(G)	FU	AV	FORD CORSAIR / CORTINA
441775(G)	FU	AV	PEUGEOT204 / 304
441776(G)	FU	AV	PORSCHE 911
441784(G)	FU	AV	TRIUMPH
441788(G)	FU	AV	FORD TAUNUS
441789(G)	FU	AV	FORD ESCORT
441797(G)	FU	AV	BMW
441814(G)	FU	AV	SIMCA FRANCE
441821(G)	FU	AV	FORD CORSAIRE / CORTINA
441837(G)	FU	AV	FORD TAUNUS
441838(G)	FU	AV	PEUGEOT504
441841(G)	FU	AV	BMW 1502 --> 2202
441848(G)	FU	AV	FORD CAPRI
441874(G)	FU	AV	MAZDA 121 --> 929 / 1000 --> 1800 / A --> Z
441905(G)	FU	AV	DAF 33
441907(G)	FU	AV	VOLKSWAGEN 1302 / 1303
441937(G)	FU	AV	PORSCHE 911 & 912 / 914 VOLKSWAGEN 914
441967(G)	FU	AV	DAF 31 / 33 / 600 / 750 / DAFFODIL
441969(G)	FU	AV	DAF 44
441971(G)	FU	AV	DAF 46 / 55 / 66 / 1300 VOLVO 66
441973(G)	FU	AV	TALBOT FRANCE 160 - 180 CHRYSLER 180
441977(G)	FU	AV	PEUGEOT404
441979(G)	FU	AV	PEUGEOT204 / 304
441995(G)	FU	AV	VOLKSWAGEN 411
441998(G)	FU	AV	CHRYSLER HUNTER HILLMAN HUNTER / MINX HUMBER SCEPTRE SINGER NEW GAZELLE / VOGUE SUNBEAM ALPINE / RAPIER

SIAAM	Type de fixation / Mounting Type	Position	Modèle / Model
444024(G)	FU	AV	PEUGEOT504
444028(G)	FU	AV	VOLVO 740 / 760 / 780 / 940 / 960
444032(G)	FU	AV	LADA DIVA / FORMA / NATACHA / SAGONA / SAMARA
444056(G)	FU	AV	OPEL CALIBRA / VECTRA A VAUXHALL CALIBRA / CAVALIER
444090(G)	FU	AV	TOYOTA COROLLA
444126(G)	FU	AV	AUDI 80 VOLKSWAGEN PASSAT
444141(G)	FU	AV	NISSAN FAIRLADY
444164(G)	FU	AV	VOLKSWAGEN K70
444170(G)	FU	AV	LANCIA BETA/ TREVI
444179(G)	FU	AV	NISSAN BLUEBIRD / LAUREL
444193(G)	FU	AV	CITROEN LN PEUGEOT104
444197(G)	FU	AV	FORD CAPRI / ESCORT 1 & 2
444197(G)	FU	AV	FORD CAPRI / ESCORT
444206(G)	FU	AV	HONDA CIVIC
444291(G)	FU	AV	NISSAN BLUEBIRD / VIOLET
444296(G)	FU	AV	NISSAN SUNNY
444317(G)	FU	AV	DAIHATSU CHARMANT TOYOTA COROLLA
444338(G)	FU	AV	VOLKSWAGEN 1303
444343(G)	FU	AV	FORD ESCORT 1 & 2
444353(G)	FU	AV	HILLMAN AVENGER SUNBEAM AVENGER TALBOT FRANCE AVENGER
444355(G)	FU	AV	MAZDA 323 / 818 / RX3
444361(G)	FU	AV	MAZDA 929 / RX4
444373(G)	FU	AV	VOLKSWAGEN CADDY 1 / GOLF 1 / JETTA 1 / SCIROCCO
444380(G)	FU	AV	LANCIA BETA
444394(G)	FU	AV	VOLVO 240 / 260
444397(G)	FU	AV	RENAULT R14
444404(G)	FU	AV	DAIHATSU CHARMANT TOYOTA CELICA / COROLLA
444425(G)	FU	AV	VOLKSWAGEN 412
444428(G)	FU	AV	TOYOTA PUBLICA
444444(G)	FU	AV	PEUGEOT504 / 505 / 604 TALBOT FRANCE TAGORA
444468(G)	FU	AV	BMW 3E21
444492(G)	FU	AV	AUDI 50 VOLKSWAGEN DERBY / POLO 1 & 2
444507(G)	FU	AV	PEUGEOT304 / 305
444529(G)	FU	AV	NISSAN CELESTE / GALANT / LANCER
444533(G)	FU	AV	NISSAN LANCER
444588(G)	FU	AV	TOYOTA CORONNA / CRESSIDA
444606(G)	FU	AV	MAZDA 626
444630(G)	FU	AV	NISSAN BLUEBIRD / FAIRLADY / LEOPARD / SILVIA
444638(G)	FU	AV	NISSAN BLUEBIRD / LAUREL / SKYLINE /SUNNY

SIAAM	Type de fixation / Mounting Type	Position	Modèle / Model
444640(G)	FU	AV	OPEL COMBO / KADETT D - E BEDFORD ASTRA DAEWOO ARANOS & CIELO & ESPERO / LANOS & SENS / NEXIA / RACER VAUXHALL ASTRA / BELMONT
444641(G)	FU	AV	NISSAN CHERRY
444663(G)	FU	AV	TOYOTA STARLET
444666(G)	FU	AV	OPEL REKORD / COMMODORE / SENATOR VAUXHALL CARLTON / ROYALE - SENATOR / VICEROY
444667(G)	FU	AV	VOLVO 340 / 360
444677(G)	FU	AV	TRIUMPH TR7 / TR8
444685(G)	FU	AV	CHRYSLER AVENGER / SUNBEAM HILLMAN AVENGER SUNBEAM AVENGER TALBOT FRANCE SUNBEAM
444695(G)	FU	AV	MAZDA 121 / RX5
444706(G)	FU	AV	TOYOTA CARINA 1 / CELICA / COROLLA / CORONA
444712(G)	FU	AV	NISSAN SUNNY
444730(G)	FU	AV	PORSCHE 924 / 944 VOLKSWAGEN 1303
444733(G)	FU	AV	LANCIA BETA
444740(G)	FU	AV	AUDI 100 / 200 / A6 / V8
444742(G)	FU	AV	RENAULT R14
444749(G)	FU	AV	ROVER 2000>3500
444754(G)	FU	AV	NISSAN SILVIA / SUNNY / VIOLET
444758(G)	FU	AV	MAZDA RX7
444760(G)	FU	AV	BMW 5E12 / 6E24 / 7E23 / 2500>3300
444796(G)	FU	AV	PEUGEOT104
444803(G)	FU	AV	OPEL ASCONA C VAUXHALL CAVALIER
444812(G)	FU	AV	BMW 3E21
444817(G)	FU	AV	NISSAN STANZA
444840(G)	FU	AV	MAZDA 323
444845(G)	FU	AV	DAIHATSU CHARMANT TOYOTA COROLLA
444863(G)	FU	AV	HYUNDAI PONY MITSUBISHI COLT / LANCER
444869(G)	FU	AV	AUDI 80 / 90 / COUPÉ VOLKSWAGEN PASSAT 2 / SANTANA
444877(G)	FU	AV	PEUGEOT504
444878(G)	FU	AV	MITSUBISHI GALANT
444882(G)	FU	AV	MAZDA 626
444896(G)	FU	AV	MAZDA 929
444924(G)	FU	AV	BMW 3E30
444926(G)	FU	AV	BMW 3E30
444950(G)	FU	AV	OPEL ASCONA C VAUXHALL CAVALIER
444951(G)	FU	AV	VOLKSWAGEN GOLF 2 / JETTA 2
444966(G)	FU	AV	TOYOTA CELICA / CRESSIDA
444975(G)	FU	AV	TOYOTA TERCEL
444996(G)	FU	AV	PEUGEOT505
445100(G)	FU	AV	BMW 5E34

SIAAM	Type de fixation / Mounting Type	Position	Modèle / Model
445107(G)	FU	AV	AUDI 80 / CABRIOLET / COUPÉ
445109(G)	FU	AV	BMW 5E34
445156(G)	FU	AV	BEDFORD ASTRA OPEL ASTRA F VAUXHALL ASTRA
445157(G)	FU	AV	OPEL ASTRA F VAUXHALL ASTRA
445159(G)	FU	AV	CITROEN AX / SAXO PEUGEOT106
445173(G)	FU	AV	TOYOTA CARINA 2 / COROLLA / CORONA
445202(G)	FU	AV	TOYOTA RAV 4
445211(G)	FU	AV	BMW 5E34
445212(G)	FU	AV	BMW 5E34
445228(G)	FU	AV	TOYOTA COROLLA
445272(G)	FU	AV	OPEL CALIBRA / VECTRA A VAUXHALL CALIBRA / CAVALIER
445348(G)	FU	AR	AUDI 80 / 90 / COUPÉ
454142(G)	FU	AR	NISSAN FAIRLADY
454181(G)	FU	AR	LANCIA BETA / TREVI
454207(G)	FU	AR	HONDA CIVIC
454391(G)	FU	AR	LANCIA BETA
454477(G)	FU	AR	LANCIA BETA
454818(G)	FU	AR	NISSAN STANZA
455140(G)	FU	AR	AUDI 80 / 90 / COUPÉ
544001(G)	JF	AV	FORD ESCORT 5 / ORION
544002(G)	JF	AV	FORD ESCORT 5 / ORION
544008(G)	JF	AV	FORD FIESTA 3 / COURRIER
544011(G)	JF	AV	HONDA CIVIC & BALLADE / CONCERTO --> Z
544013(G)	JF	AV	HONDA CIVIC & BALLADE / CONCERTO --> Z
544020(G)	JF	AV	PEUGEOT405
544039(G)	JF	AV	RENAULT R19
544040(G)	JF	AV	PEUGEOTJ5 CITROËN C25 FIAT DUCATO
544042(G)	JF	AV	FIAT 127 / FIORINO
544044(G)	JF	AV	FORD FIESTA3
544048(G)	JF	AV	RENAULT SUPER5
544049(G)	JF	AV	SEAT IBIZA 1 / MALAGA
544053(G)	JF	AV	PEUGEOT309
544058(G)	JF	AV	FIAT BRAVA / BRAVO 1 / TEMPRA / TIPO
544061(G)	JF	AV	FORD SIERRA
544091(G)	JF	AV	SEAT CORDOBA 1 / IBIZA 2 / TOLEDO 1 VOLKSWAGEN GOLF 2 & 3 / JETTA
544092(G)	JF	AV	SEAT CORDOBA 1 / IBIZA 2 & 3 / TOLEDO 1 VOLKSWAGEN GOLF 2 & 3 / GOLF CABRIOLET & BREAK / JETTA / VENTO
544097(G)	JFG	AVG	CITROEN ZX
544098(G)	JFD	AVD	CITROEN ZX
544451(G)	JF	AV	FORD FIESTA 1
544659(G)	JF	AV	AUTOBIANCHI A112 LANCIA A112

SIAAM	Type de fixation / Mounting Type	Position	Modèle / Model
544810(G)	JF	AV	FIAT 131 SEAT 131
544811(G)	JF	AV	FIAT 131 SEAT 131
544819(G)	JF	AV	CITROEN LNA / VISA / C15 PEUGEOT104 TALBOT FRANCE SAMBA
544819(G)	JF	AV	CHRYSLER SAMBA CITROËN C15 / LNA / VISA PEUGEOT104 BERLIN / 104 COUPÉ TALBOT FRANCE SAMBA
544821(G)	JF	AV	FIAT 131 SEAT 131
544825(G)	JF	AV	FIAT 127 / FIORINO POLSKI 127 P SEAT 127 - FURA
544828(G)	JF	AV	FIAT RITMO 1 SEAT RONDA ZASTAVA YUGO
544851(G)	JF	AR	AUTOBIANCHI A112 FIAT 127 / 147 / FIORINO LANCIA A112 POLSKI 127 P SEAT 124-->133 / 600-->1430
544860(G)	JF	AV	FORD ESCORT 3
544881(G)	JF	AV	FORD FIESTA 1
544884(G)	JF	AV	DACIA SOLENZA RENAULT R9 / R11
544890(G)	JF	AV	FORD SIERRA
544906(G)	JF	AV	SEAT IBIZA 1 / MALAGA / RONDA
544907(G)	JF	AV	FORD ESCORT 4 / ORION
544909(G)	JF	AV	HONDA ACCORD
544911(G)	JF	AV	PEUGEOT305
544913(G)	JF	AV	ZASTAVA YUGO
544915(G)	JF	AV	FIAT PANDA 1 SEAT MARBELLA / TERRA / TRANS
544932(G)	JF	AV	MERCEDES 190-->220
544936(G)	JF	AV	RENAULT SUPER 5
544941(G)	JF	AV	CITROEN VISA / C15 PEUGEOT205
544941(G)	JF	AV	PEUGEOT205 CITROEN VISA
544943(G)	JF	AV	FIAT PANDA 1
544944(G)	JF	AV	FORD ESCORT 4 / ORION
544945(G)	JF	AV	RENAULT SUPER5 / EXPRESS
544947(G)	JF	AV	FORD FIESTA 2
544948(G)	JFG	AVG	CITROEN VISA PEUGEOT205 / 309
544949(G)	JFD	AVD	CITROEN VISA PEUGEOT205 / 309
544954(G)	JF	AV	FIAT UNO
544958(G)	JFD	AVD	RENAULT TRAFIC 1
544959(G)	JFG	AVG	RENAULT TRAFIC 1

SIAAM	Type de fixation / Mounting Type	Position	Modèle / Model
544960(G)	JF	AV	CITROEN C25 FIATDUCATO PEUGEOTJ5 --> J9 TALBOT UTILITAIRES/COMMERCIALS
544961(G)	JF	AV	CITROËN C 25
544964(G)	JF	AV	FIAT REGATA / RITMO 2
544974(G)	JF	AV	RENAULT SUPER 5
544976(G)	JF	AV	MERCEDES 190-->220 / 230-->250 / 260-->280 / 300-->320 / 350-->450 / 500-->600
544977(G)	JF	AV	FORD FIESTA2
544981(G)	JF	AV	RENAULT R21
544982(G)	JFG	AVG	RENAULT R21
544983(G)	JFD	AVD	RENAULT R21
544989(G)	JF	AV	FORD TRANSIT2
545011(G)	JFD	AVD	HYUNDAI I10
545016(G)	JFG	AVG	DAEWOO LACETTI CHEVROLET EUROPE LACETTI - OPTRA
545017(G)	JFD	AVD	DAEWOO LACETTI CHEVROLET EUROPE LACETTI - OPTRA
545018(G)	JFG	ARG	CHEVROLET EUROPE LACETTI - OPTRA DAEWOO LACETTI
545019(G)	JFD	ARD	DAEWOO LACETTI CHEVROLET EUROPE LACETTI - OPTRA
545102(G)	JF	AV	FORD SCORPIO
545122(G)	JFD	AVD	PEUGEOT605
545123(G)	JFG	AVG	PEUGEOT605
545133(G)	JF	AV	SEAT IBIZA 1 / MALAGA
545134(G)	JF	AV	VOLKSWAGEN PASSAT 3
545141(G)	JF	AV	FIAT CROMA 1 LANCIA THEMA
545155(G)	JF	AV	CITROEN C15
545163(G)	JFG	AVG	CITROEN ZX PEUGEOT306
545164(G)	JFD	AVD	CITROEN ZX PEUGEOT306
545165(G)	JFG	AVG	CITROEN XSARA 1 / ZX PEUGEOT306
545166(G)	JFD	AVD	CITROEN XSARA 1 / ZX PEUGEOT306
545169(G)	JF	AV	FORD FIESTA3
545174(G)	JFG	AVG	CITROEN ZX
545175(G)	JFD	AVD	CITROEN ZX
545179(G)	JF	AV	OPEL COMBO / CORSA A & B / TIGRA
545183(G)	JF	AV	NISSAN MICRA
545189(G)	JF	AV	RENAULT TWINGO 1
545190(G)	JF	AV	RENAULT LAGUNA 1
545193(G)	JF	AV	FIAT PUNTO 1
545195(G)	JF	AV	RENAULT CLIO 1
545196(G)	JF	AV	RENAULT CLIO 1
545197(G)	JF	AV	RENAULT CLIO 1
545199(G)	JF	AV	RENAULT LAGUNA 1



SIAAM	Type de fixation / Mounting Type	Position	Modèle / Model
545201(G)	JF	AV	SEAT AROSA / CORDOBA 1 / IBIZA 2 & 3 / INCA / TOLEDO 1 VOLKSWAGEN CADDY / GOLF 3 / GOLF BREAK / LUPO / POLO / VENTO
545206(G)	JF	AV	SUZUKI SANTANA / VITARA
545214(G)	JF	AV	PEUGEOT405
545215(G)	JF	AV	FIAT CINQUECENTO / SEICENTO
545216(G)	JF	AV	FIAT TEMPRA / TIPO LANCIA DEDRA / DELTA
545217(G)	JF	AV	FORD FIESTA4
545219(G)	JF	AV	FORD FIESTA 4 / COURRIER
545223(G)	JF	AV	FORD MONDEO 1
545229(G)	JF	AV	FORD TRANSIT3
545233(G)	JF	AV	RENAULT SAFRANE
545239(G)	JF	AV	SKODA FAVORIT / FORMAN
545240(G)	JFG	AVG	BMW 3E36
545246(G)	JFG	AVG	BMW 3E36
545247(G)	JFD	AVD	BMW 3E36
545248(G)	JFG	AVG	BMW 3E36
545249(G)	JFD	AVD	BMW 3E36
545251(G)	JFD	AVD	BMW 3E36
545252(G)	JFG	AVG	BMW 3E36
545253(G)	JFD	AVD	BMW 3E36
545255(G)	JF	AV	VOLKSWAGEN PASSAT 3
545260(G)	JF	AV	RENAULT R19
545263(G)	JF	AV	CITROEN JUMPER & RELAY FIAT DUCATO PEUGEOTBOXER
545265(G)	JF	AV	FORD ESCORT 5
545274(G)	JF	AV	AUDI A3 SEAT LEON 1 / TOLEDO 2 SKODA OCTAVIA 1 VOLKSWAGEN BEETLE / BORA / GOLF 4 / GOLF BREAK
545278(G)	JFG	AVG	OPEL VECTRA B VAUXHALL VECTRA
545279(G)	JFD	AVD	OPEL VECTRA B VAUXHALL VECTRA
545280(G)	JFG	AVG	CITROEN BERLINGO 1 / XSARA 1 & 2 PEUGEOT306 / PARTNER & RANCH
545282(G)	JF	AV	VOLVO 440 / 460 / 480
545284(G)	JF	AV	CITROEN EVASION FIAT ULYSSE 1 LANCIA ZETA PEUGEOT806
545284(G)	JF	AV	PEUGEOT806 CITROEN EVASION
545285(G)	JF	AV	LANCIA Y
545287(G)	JF	AV	RENAULT ESPACE 3
545289(G)	JF	AV	CITROËN JUMPY & DISPATCH FIAT SCUDO PEUGEOTEXPERT
545289(G)	JF	AV	CITROËN JUMPY & DISPATCH FIAT SCUDO PEUGEOTEXPERT

SIAAM	Type de fixation / Mounting Type	Position	Modèle / Model
545291(G)	JFD	AVD	CITROEN BERLINGO 1 / XSARA 1 & 2 PEUGEOT306 / PARTNER & RANCH
545293(G)	JFG	AVG	CITROEN BERLINGO 1 / XSARA 1 PEUGEOT306 / PARTNER & RANCH
545294(G)	JFD	AVD	CITROEN BERLINGO 1 / XSARA 1 PEUGEOT306 / PARTNER & RANCH
545295(G)	JF	AV	RENAULT MÉGANE 1 / SCENIC 1
545297(G)	JF	AV	CHRYSLER VOYAGER 1
545299(G)	JF	AV	RENAULT SUPER 5 EXPRESS
545311(G)	JF	AV	FIAT BRAVA / BRAVO 1
545312(G)	JF	AV	FIAT PUNTO 1
545314(G)	JFG	AVG	PEUGEOT406
545315(G)	JFD	AVD	PEUGEOT406
545323(G)	JF	AV	FORD ESCORT 6
545324(G)	JF	AV	FORD ESCORT 6
545328(G)	JF	AV	FORD COURRIER / FIESTA 5 / PUMA MAZDA 121
545329(G)	JF	AV	FORD COURRIER / FIESTA 5 MAZDA 121
545331(G)	JF	AV	RENAULT MÉGANE 1
545335(G)	JF	AV	FORD MONDEO 1
545336(G)	JF	AV	FORD GALAXY SEAT ALHAMBRA VOLKSWAGEN SHARAN
545338(G)	JF	AV	FORD KA 1
545340(G)	JFD	AVD	PEUGEOT605
545349(G)	JFG	AVG	PEUGEOT605
545350(G)	JFD	AVD	NISSAN MICRA2
545351(G)	JF	AV	SKODA FELICIA
545357(G)	JFG	AVG	NISSAN ALMERA
545358(G)	JFD	AVD	NISSAN ALMERA
545359(G)	JFG	AVG	NISSAN MICRA2
545365(G)	JF	AV	RENAULT CLIO1
545366(G)	JF	AV	RENAULT CLIO2
545367(G)	JF	AV	RENAULT CLIO2
545368(G)	JFG	AVG	ALFAROMEO 145 / 146
545369(G)	JFD	AVD	ALFAROMEO 145 / 146
545376(G)	JF	AV	FIAT BRAVA / BRAVO 1
545377(G)	JF	AV	FIAT MAREA
545400(G)	JFD	AVD	FORD FOCUS1
545401(G)	JFD	AVD	BMW 3E46
545402(G)	JFG	AVG	BMW 3E46
545403(G)	JFD	AVD	BMW 3E46
545405(G)	JF	AV	FIAT MULTIPLA
545407(G)	JF	AV	FIAT PUNTO2
545409(G)	JFG	AVG	FORD FOCUS1
545435(G)	JF	AV	RENAULTSCENIC1
545438(G)	JF	AV	NISSAN KUBISTAR RENAULT KANGOO 1
545454(G)	JFG	AVG	TOYOTA STARLET

SIAAM	Type de fixation / Mounting Type	Position	Modèle / Model
545455(G)	JFD	AVD	TOYOTA STARLET
545460(G)	JFD	AVD	PEUGEOT206
545469(G)	JFG	AVG	PEUGEOT206
545471(G)	JFG	AVG	RENAULT TRAFFIC
545472(G)	JFD	AVD	RENAULT TRAFFIC
545473(G)	JF	AV	SEAT MARBELLA
545482(G)	JFG	AVG	PEUGEOT206 / 206+
545483(G)	JFD	AVD	PEUGEOT206 / 206+
545490(G)	JFG	AVG	BMW 3E46
545497(G)	JF	AV	FIAT PUNTO 2
545501(G)	JF	AV	AUDI A2 SKODA FABIA 1 & 2 VOLKSWAGEN POLO 4
545505(G)	JF	AV	CITROËN JUMPER & RELAY FIAT DUCATO
545506(G)	JFG	AVG	CITROEN XSARA 2
545507(G)	JFD	AVD	CITROEN XSARA 2
545508(G)	JFG	AVG	CITROEN C4 PEUGEOT307
545509(G)	JFD	AVD	CITROEN C4 PEUGEOT307
545517(G)	JF	AV	FORD COUGAR
545518(G)	JF	AR	FORD COUGAR
545519(G)	JF	AV	MERCEDES "V" KLASSE / VITO
545520(G)	JFG	AVG	OPEL ASTRA G
545521(G)	JF	AV	TOYOTA YARIS1
545522(G)	JF	AV	TOYOTA YARIS 1 / YARISVERSO
545528(G)	JF	AV	FIAT PUNTO 2
545531(G)	JFD	AVD	OPEL ASTRA G
545532(G)	JFG	AVG	OPEL ASTRA G
545533(G)	JFD	AVD	OPEL ASTRA G
545540(G)	JF	AV	MERCEDES SPRINTER VOLKSWAGEN LT
545541(G)	JF	AV	FIAT PALIO / SIENA
545542(G)	JFG	AVG	CITROEN PICASSO
545543(G)	JFD	AVD	CITROEN PICASSO
545543(G)	JFD	AVD	OPEL MERIVA
545547(G)	JF	AV	ROVER 200
545549(G)	JF	AV	MERCEDES "A" KLASSE
545550(G)	JF	AV	FIAT DOBLÒ 1
545551(G)	JF	AV	RENAULT TWINGO
545552(G)	JFG	AVG	OPEL ZAFIRA 1 VAUXHALL ZAFIRA
545553(G)	JFD	AVD	OPEL ZAFIRA 1 VAUXHALL ZAFIRA
545558(G)	JF	AV	FORD MONDEO 2
545562(G)	JF	AV	RENAULT SCENIC 1
545563(G)	JF	AV	AUDI A2 SKODA FABIA 1 & 2

SIAAM	Type de fixation / Mounting Type	Position	Modèle / Model
545566(G)	JF	AV	SEAT CORDOBA 2 / IBIZA 4 SKODA ROOMSTER VOLKSWAGEN FOX / POLO
545568(G)	JF	AV	OPEL COMBO / CORSA C / MERIVA
545569(G)	JF	AV	OPEL CORSA C
545578(G)	JF	AV	RENAULT LAGUNA 2
545580(G)	JFG	AVG	CITROEN C2 / C3 PH.1 & CLASSIC PEUGEOT1007
545588(G)	JF	AV	NISSAN KUBISTAR RENAULT KANGOO1
545591(G)	JFD	AVD	CITROEN C2 / C3 PH.1 & CLASSIC PEUGEOT1007
545593(G)	JF	AV	NISSAN PRIMASTAR OPEL VIVARO RENAULT TRAFIC 2 / TRAFIC 3
545594(G)	JFG	AVG	CITROEN C4 PEUGEOT307
545595(G)	JFD	AVD	CITROEN C4 PEUGEOT307
545599(G)	JF	AV	FIAT IDEA LANCIA MUSA / YPSILON 2
545600(G)	JFD	AVD	FIAT CROMA 2 OPEL SIGNUM / VECTRA C
545604(G)	JFD	AVD	CITROEN NEMO FIAT FIORINO / GRANDE PUNTO / LINEA / PUNTO PEUGEOTBIPPER
545607(G)	JFG	AVG	PEUGEOT207
545608(G)	JFD	AVD	PEUGEOT207
545609(G)	JFG	AVG	FIAT CROMA 2 OPEL SIGNUM / VECTRA C
545610(G)	JF	AV	MERCEDES SPRINTER VOLKSWAGEN LT
545611(G)	JF	AV	AUDI A3 SEAT ALHAMBRA / ALTEA / LEON 2 / TOLEDO 3 SKODA OCTAVIA 2 / SUPERB 2 / YATI VOLKSWAGEN CADDY 3 / EOS / GOLF 5 & 6 / GOLF PLUS / JETTA 3 / PASSAT 6 & 7 / SCIROCCO / SHARAN 2
545612(G)	JF	AV	AUDI A3 SEAT ALHAMBRA / ALTEA / LEON 2 / TOLEDO 3 SKODA OCTAVIA 2 / SUPERB 2 VOLKSWAGEN CADDY 3 / EOS / GOLF 5 & 6 / GOLF PLUS / JETTA 3 / PASSAT 6 & 7 / SCIROCCO / SHARAN 2
545614(G)	JF	AV	VOLKSWAGEN TOURAN
545617(G)	JF	AV	FORD TOURNEO / CONNECT
545622(G)	JF	AV	RENAULT MÉGANE 2
545624(G)	JF	AV	FIAT BRAVO 2 / STILO
545626(G)	JF	AV	FIAT PALIO / SIENA
545628(G)	JFG	AVG	BMW 3E46
545629(G)	JFD	AVD	BMW 3E46
545634(G)	JFG	AVG	NISSAN MICRA2
545634(G)	SC	AR	MERCEDES BENZ CLASSE E
545635(G)	JFD	AVD	NISSAN MICRA2

SIAAM	Type de fixation / Mounting Type	Position	Modèle / Model
545641(G)	JFG	AVG	FORD FIESTA6 MAZDA 2
545642(G)	JFD	AVD	FORD FIESTA6 MAZDA 2
545650(G)	JFG	AVG	FORD FUSION
545654(G)	JFG	AVG	TOYOTA RAV 4
545655(G)	JFD	AVD	TOYOTA RAV 4
545661(G)	JFD	AVD	FORD FUSION
545668(G)	JF	AV	DACIA LOGAN / SANDERO
545671(G)	JFG	AVG	FORD C-MAX / FOCUS 2
545672(G)	JFD	AVD	FORD C-MAX / FOCUS 2
545674(G)	JF	AV	RENAULT CLIO3 / MODUS / GRAND MODUS
545676(G)	JFG	AVG	CITROEN C8 FIAT ULYSSE 2 LANCIA PHEDRA PEUGEOT807
545677(G)	JFD	AVD	CITROEN C8 FIAT ULYSSE 2 LANCIA PHEDRA PEUGEOT807
545681(G)	JFG	AVG	MAZDA 3
545682(G)	JFD	AVD	MAZDA 3
545688(G)	JFG	AVG	TOYOTA RAV 4
545689(G)	JFD	AVD	TOYOTA RAV 4
545691(G)	JFG	AVG	FIAT PANDA 2
545692(G)	JFD	AVD	FIAT PANDA 2
545696(G)	JFG	AVG	CITROEN C1 PEUGEOT107 TOYOTA AYGO
545697(G)	JFD	AVD	CITROEN C1 PEUGEOT107 TOYOTA AYGO
545699(G)	JF	AV	RENAULT SCENIC 2
545703(G)	JFG	AVG	CITROEN C3 PH.2 / DS3
545704(G)	JFD	AVD	CITROEN C3 PH.2 / DS3
545705(G)	JFG	AVG	FORD EUROPE FIESTA 7
545706(G)	JFD	AVD	FORD EUROPE FIESTA 7
545708(G)	JF	AV	FORD TRANSIT4
545710(G)	JFD	AVD	CITROEN C2 / C3 PH.1 / C3PLURIEL
545711(G)	JF	AV	RENAULT TWINGO 2
545713(G)	JF	AV	RENAULT MÉGANE 2
545716(G)	JFG	AVG	OPEL ASTRA H / ZAFIRA 2
545717(G)	JFD	AVD	OPEL ASTRA H / ZAFIRA 2
545719(G)	JFG	AVG	CITROEN C2 / C3 PH.1 / C3PLURIEL
545720(G)	JFD	AVD	OPEL AGILA 2 SUZUKI SPLASH / SWIFT
545726(G)	JFG	AVG	NISSAN NOTE
545727(G)	JFD	AVD	NISSAN NOTE
545729(G)	JFG	AVG	OPEL AGILA 2 SUZUKI SPLASH / SWIFT
545730(G)	JFD	AVD	OPEL SIGNUM / VECTRA C
545735(G)	JFG	AVG	OPEL CORSA D

SIAAM	Type de fixation / Mounting Type	Position	Modèle / Model
545736(G)	JFD	AVD	OPEL CORSA D
545737(G)	JFG	AVG	FORD GALAXY 2 / MONDEO 4 / S-MAX
545738(G)	JFD	AVD	FORD GALAXY 2 / MONDEO 4 / S-MAX
545739(G)	JFG	AVG	OPEL SIGNUM / VECTRA C
545744(G)	JFG	AVG	FIAT 500 FORD KA 2
545745(G)	JFD	AVD	FIAT 500 FORD KA 2
545747(G)	JF	AV	RENAULT TWINGO 2
545750(G)	JF	AV	RENAULT LAGUNA 3
545751(G)	JF	AV	AUDI A1 SEAT IBIZA 5 VOLKSWAGEN POLO 5
545753(G)	JFG	AVG	FORD KA1
545754(G)	JFD	AVD	FORD KA1
545755(G)	JFG	AVG	BMW 1E80 / 3E90
545756(G)	JFD	AVD	BMW 1E80 / 3E90
545759(G)	JF	AV	MERCEDES UTILITAIRES / COMMERCIALS VOLKSWAGEN CRAFTER
545762(G)	JF	AV	RENAULT KANGOO
545766(G)	JFG	AVG	TOYOTA YARIS 2 & 3
545767(G)	JFD	AVD	TOYOTA YARIS 2 & 3
545771(G)	JFG	AVG	PEUGEOT207
545772(G)	JFD	AVD	PEUGEOT207
545774(G)	JFG	AVG	CITROEN C3 PICASSO
545775(G)	JFD	AVD	CITROEN C3 PICASSO
545780(G)	JFD	AVD	ALFA ROMEO MITO
545782(G)	JF	AV	AUDI A4 / A5
545784(G)	JFG	AVG	CITROEN C3 PH.2 / DS3
545785(G)	JFD	AVD	CITROEN C3 PH.2 / DS3
545786(G)	JFG	AVG	PEUGEOT308
545787(G)	JFD	AVD	PEUGEOT308
545789(G)	JFG	AVG	ALFA ROMEO MITO
545795(G)	JFG	AVG	PEUGEOT607
545796(G)	JFD	AVD	PEUGEOT607
545801(G)	JFG	AVG	FIAT DOBLO
545802(G)	JFD	AVD	FIAT DOBLO
545804(G)	JFG	AVG	CITROËN JUMPY & DISPATCH FIAT SCUDO PEUGEOTEXPERT
545805(G)	JFD	AVD	CITROËN JUMPY & DISPATCH FIAT SCUDO PEUGEOTEXPERT
545806(G)	JFG	AVG	ALFA ROMEO GIULIETTA 940
545807(G)	JFD	AVD	ALFA ROMEO GIULIETTA 940
545810(G)	JFG	AVG	CITROEN C4 PICASSO
545813(G)	JF	AV	DACIA DUSTER
545816(G)	JFG	AVG	PEUGEOT3008
545817(G)	JFD	AVD	PEUGEOT3008
545820(G)	JFD	AVD	PEUGEOT5008
545821(G)	JFD	AVD	CITROEN C4 PICASSO

SIAAM	Type de fixation / Mounting Type	Position	Modèle / Model
545822(G)	JFG	AVG	NISSAN QASHQAI
545823(G)	JFD	AVD	NISSAN QASHQAI
545825(G)	JFG	AVG	RENAULT KOLEOS
545826(G)	JFD	AVD	RENAULT KOLEOS
545828(G)	JF	AV	FIAT DUCATO CITROËN JUMPER & RELAY PEUGEOTBOXER
545829(G)	JFG	AVG	PEUGEOT5008
545830(G)	JF	AV	FIAT DUCATO CITROËN JUMPER & RELAY PEUGEOTBOXER
545832(G)	JFG	AVG	BMW Z4
545833(G)	JFD	AVD	BMW Z4
545837(G)	JFG	AVG	CITROEN C4 / DS4
545838(G)	JFD	AVD	CITROEN C4 / DS4
545841(G)	JF	AV	RENAULT MÉGANE3
545842(G)	JFG	AVG	OPEL MERIVA B
545846(G)	JF	AV	RENAULT KANGOO
545847(G)	JFG	AVG	CHEVROLET EUROPE AVEO / KALOS DAEWOO KALOS
545848(G)	JFD	AVD	CHEVROLET EUROPE AVEO / KALOS DAEWOO KALOS
545852(G)	JF	AV	RENAULT SCENIC 3
545855(G)	JF	AV	RENAULT FLUENCE
545857(G)	JF	AV	VOLKSWAGEN TIGUAN
545864(G)	JFG	AVG	OPEL ASTRA J
545865(G)	JFD	AVD	OPEL ASTRA J
545867(G)	JFG	AVG	OPEL INSIGNIA
545868(G)	JFD	AVD	OPEL INSIGNIA
545870(G)	JFD	AVD	FORD EUROPE C-MAX 2 / FOCUS 3
545873(G)	JF	AV	DACIA SANDERO 2
545876(G)	JF	AV	RENAULT CLIO 4
545879(G)	JFG	AVG	FORD EUROPE C-MAX 2 / FOCUS 3
545881(G)	JFG	AVG	PEUGEOT208
545882(G)	JFD	AVD	PEUGEOT208
545883(G)	JFG	AVG	PEUGEOT208
545884(G)	JFD	AVD	PEUGEOT208
545887(G)	JF	AV	DACIA LODGY
545889(G)	JF	AV	DACIA DOKKER
545891(G)	JF	AV	DACIA LOGAN 2
545892(G)	JF	AV	DACIA SANDERO 2
545896(G)	JFG	AVG	OPEL AGILA SUZUKI WAGON R+
545897(G)	JFD	AVD	OPEL AGILA SUZUKI WAGON R+
545898(G)	JFG	AVG	HYUNDAI ACCENT III / VERNA II KIA RIO II
545899(G)	JFD	AVD	HYUNDAI ACCENT III / VERNA II KIA RIO II
545900(G)	JFG	AVG	HYUNDAI I10
545902(G)	JFD	AVD	TOYOTA YARIS 3 XP 15 / VIOS

SIAAM	Type de fixation / Mounting Type	Position	Modèle / Model
545903(G)	JFG	AVG	TOYOTA YARIS 3 XP 15 / VIOS
545912(G)	JFG	AVG	CITROËN C-ELYSEE PEUGEOT301
545913(G)	JF	AV	CITROËN C-ELYSEE PEUGEOT301
545914(G)	JFG	AVG	KIA PICANTO HYUNDAI I10
545915(G)	JFD	AVD	KIA PICANTO HYUNDAI I10
545917(G)	JFG	AVG	KIA CERATO
545918(G)	JFD	AVD	KIA CERATO
545922(G)	JF	AV	PEUGEOT 308 II
545926(G)	JFG	AVG	KIA PICANTO 2
545927(G)	JFD	AVD	KIA PICANTO 2
545938(G)	JFG	AVG	HYUNDAI / KIA: ACCENT 4 / RIO 3
545939(G)	JFD	AVD	HYUNDAI / KIA: ACCENT 4 / RIO 3
545940(G)	JFG	AVG	PEUGEOT 2008 Ø 51
545941(G)	JFG	AVG	HYUNDAI I20
545942(G)	JFD	AVD	HYUNDAI I20
545951(G)	JFD	AVD	PEUGEOT 2008 Ø 51
545953(G)	JFG	AVG	CITROEN C4 CACTUS
545954(G)	JFD	AVD	CITROEN C4 CACTUS
545956(G)	JFG	AVG	OPEL MOKKA
545957(G)	JFD	AVD	OPEL MOKKA
545959(G)	JF	AV	RENAULT TWINGO 3
545961(G)	JFG	AVG	OPEL ADAM
545962(G)	JFD	AVD	OPEL ADAM
545964(G)	JFG	AVG	TOYOTA Corolla E120 GB / J 5 portes 2002 --> 2007
545965(G)	JFD	AVD	TOYOTA Corolla E120 GB / J 5 portes 2002 --> 2007
545966(G)	SR	AR	TOYOTA Corolla E120 GB / J 5 portes 2002 --> 2007
545967(G)	JFG	AVG	TOYOTA COROLLA E140 J
545968(G)	JFD	AVD	TOYOTA COROLLA E140 J
545972(G)	JFG	AVG	NISSAN JUKE
545973(G)	JFD	AVD	NISSAN JUKE
545975(G)	JFG	AVG	TOYOTA RAV 4 III
545976(G)	JFD	AVD	TOYOTA RAV 4 III
545978(G)	JFG	AVG	NISSAN MICRA 4
545979(G)	JFD	AVD	NISSAN MICRA 4
545990(G)	JFD	AVD	HYUNDAI / KIA IX35 / SPORTAGE
545991(G)	JFG	AVG	HYUNDAI ELANTRA 2
545992(G)	JFD	AVD	HYUNDAI ELANTRA 2
545993(G)	JFG	AVG	KIA ELANTRA 2
545994(G)	JFD	AVD	KIA CERATO 3 / FORTE 2
545996(G)	JFG	AVG	HYUNDAI GRAND I10
545997(G)	JFD	AVD	HYUNDAI GRAND I10
545999(G)	JFG	AVG	HYUNDAI / KIA IX35 / SPORTAGE
548222(G)	JF	AV	FIAT DOGAN
548443(G)	JF	AV	FIAT UNO MILLE
548681(G)	JFG	AVG	DAEWOO NUBIRA II
548682(G)	JFD	AVD	DAEWOO NUBIRA II



SIAAM	Type de fixation / Mounting Type	Position	Modèle / Model
554012(G)	JF	AR	HONDA CIVIC & BALLADE / CONCERTO-->Z
554043(G)	JF	AR	FIAT FIORINO
554452(G)	JF	AR	FORD FIESTA 1 & 2
554769(G)	JF	AR	FIAT REGATA / RITMO 1 & 2 SEAT IBIZA 1 / MALAGA / RONDA
554852(G)	JF	AR	FIAT 128 SEAT 128 ZASTAVA 101 & 128 / YUGO
554871(G)	JF	AR	FORD ESCORT 3 & 4 / ORION
554900(G)	JF	AR	HONDA ACCORD
554923(G)	JF	AR	RENAULT R20 / R30
554931(G)	JF	AR	RENAULT R25
555142(G)	JF	AR	FIAT CROMA 1 LANCIA THEMA
555225(G)	JF	AR	FORD MONDEO 1
555235(G)	JF	AR	RENAULT SAFRANE
555559(G)	JF	AR	FORD MONDEO 3
555815(G)	JF	AR	DACIA DUSTER
558444(G)	JF	AR	FIAT FIORINO / UNO
558683(G)	JFG	ARG	DAEWOO NUBIRA II
558684(G)	JFD	ARD	DAEWOO NUBIRA II
613214(G)	RC	AR	RENAULT R21 / NEVADA
613216(G)	RC	AR	FORD COURRIER
701059(G)	PLL	AV	RENAULT SG-SERIES
704442(G)	PLL	AV	LANDROVER 107
714004(G)	PLL	AR	TOYOTA LAND CRUISER
714018(G)	PLL	AR	JEEP GRAND CHEROKEE RENAULT CHEROKEE
714022(G)	PLL	AR	MERCEDES L-SERIES
714063(G)	PLL	AR	NISSAN PATROL
714067(G)	PLL	AR	TOYOTA LAND CRUISER
714077(G)	PLL	AR	TOYOTA FOUR RUNNER
714744(G)	PLL	AR	RENAULT SG
714833(G)	PLL	AR	ARO (4X4) 24
714968(G)	PLL	AR	CITROEN C25 FIAT DUCATO / TALENTO PEUGEOTJ5 --> J9 TALBOT U.K UTILITAIRES / COMMERCIALS
714988(G)	PLL	AR	FORD TRANSIT2
715034(G)	PLL	AR	FORD EUROPE RANGER
715121(G)	PLL	AR	FREIGHT ROVER SHERPA
715244(G)	PLL	AR	FIAT DUCATO CITROËN JUMPER & RELAY PEUGEOTBOXER
715322(G)	PLL	AR	ISUZU TROOPER OPEL MONTEREY VAUXHALL MONTEREY
715477(G)	PLL	AR	HYUNDAI GALLOPER
715489(G)	PLL	AR	MITSUBISHI L-SERIES
715496(G)	PLL	AR	OPEL FRONTERA A VAUXHALL FRONTERA
715573(G)	PLL	AR	NISSAN PATROL

SIAAM	Type de fixation / Mounting Type	Position	Modèle / Model
715666(G)	PLL	AR	MITSUBISHI PAJERO SPORT
715794(G)	PLL	AR	NISSAN PATHFINDER
715861(G)	PLL	AR	FIAT DUCATO CITROËN JUMPER & RELAY PEUGEOTBOXER
715861(G)	PLL	AR	CITROEN JUMPER FIAT DUCATO PEUGEOTBOXER
715862(G)	PLL	AR	CITROEN JUMPER FIAT DUCATO PEUGEOTBOXER
715862(G)	PLL	AR	FIAT DUCATO CITROËN JUMPER & RELAY PEUGEOTBOXER
715863(G)	PLL	AR	CITROEN JUMPER & RELAY FIAT DUCATO PEUGEOTBOXER
715863(G)	PLL	AR	FIAT DUCATO CITROËN JUMPER & RELAY PEUGEOTBOXER
724068(G)	PLL	AV	TOYOTA LAND CRUISER
724866(G)	PLL	AV	PEUGEOT P4 MERCEDES "G" KLASSE
725333(G)	PLL	AV	MERCEDES "G" KLASSE
734069(G)	PLL	AR	TOYOTA LAND CRUISER
735459(G)	PLL	AR	VOLKSWAGEN TRANSPORTER / CARAVELLE
744003(G)	PLL	AV	TOYOTA LAND CRUISER
744017(G)	PLL	AV	JEEP GRAND CHEROKEE RENAULT GRAND CHEROKEE
744066(G)	PLL	AV	TOYOTA LAND CRUISER
744073(G)	PLL	AV	TOYOTA HI-LUX VOLKSWAGEN TARO
744075(G)	PLL	AV	TOYOTA FOUR RUNNER / HI-LUX VOLKSWAGEN TARO
744081(G)	PLL	AV	MITSUBISHI L-SERIES
744832(G)	PLL	AV	ARO (4X4) 24
744938(G)	PLL	AV	VOLKSWAGEN TRANSPORTER
744987(G)	PLL	AV	FORD TRANSIT 2
745033(G)	PLL	AV	FORD EUROPE RANGER
745268(G)	PLL	AV	MITSUBISHI PAJERO
745310(G)	PLL	AV	OPEL FRONTERA / MONTEREY VAUXHALL FRONTERA / MONTEREY
745319(G)	PLL	AV	ISUZU TROOPER OPEL FRONTERA / MONTEREY VAUXHALL FRONTERA / MONTEREY
745458(G)	PLL	AV	VOLKSWAGEN TRANSPORTER / CARAVELLE
745476(G)	PLL	AV	HYUNDAI GALLOPER
745488(G)	PLL	AV	MITSUBISHI L-SERIES
745658(G)	PLL	AV	SSONGYONG MUSSO
745658(G)	PLL	AV	SSANGYONG MUSSO
745663(G)	PLL	AV	HYUNDAI TERRACAN
751879(G)	PLL	AR	RENAULT SG SERIES
754078(G)	PLL	AR	TOYOTA FOUR RUNNER

SIAAM	Type de fixation / Mounting Type	Position	Modèle / Model
754867(G)	PLL	AR	PEUGEOT P4 MERCEDES "G" KLASSE
754867(G)	PLL	AR	MERCEDES "G" KLASSE PEUGEOT P4
755269(G)	PLL	AR	mitsubishi pajero
755334(G)	PLL	AR	MERCEDES "G" KLASSE
755574(G)	PLL	AR	TOYOTA LAND CRUISER
755664(G)	PLL	AR	HYUNDAI TERRACAN
755808(G)	SC	AR	ALFA ROMEO GIULIETTA 940
755960(G)	GC	AR	TOYOTA COROLLA E170 / AURIS E150
761878(G)	PLL	AV	RENAULT SG SERIES
764060(G)	PLL	AV	TOYOTA LAND CRUISER
764062(G)	PLL	AV	NISSAN PATROL
764836(G)	PLL	AV	NISSAN PATROL
765572(G)	PLL	AV	NISSAN PATROL
771659(G)	PL	AR	RENAULT SG
774231(G)	PLL	AR	RENAULT SG
814441(G)	PL	AR	LAND ROVER (4X4) SANTANA
825480(G)	PL	AV	LAND ROVER (4X4) RANGE
830121(G)	PL	AR	LAND ROVER DISCOVERY 1
834047(G)	PL	AR	LAND ROVER (4X4) DEFENDER 1
834443(G)	PL	AR	LANDROVER 109 / 119
835491(G)	PL	AR	LAND ROVER (4X4) RANGE
841899(G)	PL	AV	RENAULT SB
854071(G)	PL	AR	TOYOTA LAND CRUISER
860110(G)	PL	AV	LAND ROVER 90>130 / DEFENDER / DISCOVERY / RANGE
871718(G)	PL	AR	EBRO THAMES TRADER FORD TRANSIT
871890(G)	PL	AR	RENAULT SB
5459443(G)	JF	AV	RENAULT MASTER 3





2019 <sup>AMORTISSEURS</sup> SIAAM  
CATALOGUE



**AMORTISSEURS | SHOCK ABSORBERS | AMORTIGUADORES | STÖßDÄMPFER**

Z.I BIR EL KASSÂA RUE DE LA LAINE BP 164 - 2013 / BEN AROUS - TUNISIE

TÉL.: (+216) 71 385 024 / FAX: (+216) 71 381 109

EMAIL: [INFO@SIA-AM.COM](mailto:INFO@SIA-AM.COM) / [WWW.SIA-AM.COM](http://WWW.SIA-AM.COM)